



**FRESENIUS
MEDICAL CARE**

Crit-Line IV User's Guide

This Page Intentionally Blank

Crit Line IV User's Guide

© Copyright 2016, 2017, 2018, 2022 Fresenius USA, Inc.—All Rights Reserved

This document contains proprietary information of Fresenius Medical Care Renal Therapies Group, LLC and its affiliates (“Fresenius Medical Care”). The contents of this document may not be disclosed to third parties, copied, or duplicated in any form, in whole or in part, without the prior written permission of Fresenius Medical Care.

Fresenius Medical Care, the triangle logo, Crit-Line IV and CLiC are trademarks of Fresenius Medical Care Holdings, Inc., and/or its affiliated companies. All other trademarks are the property of their respective owners.

Caution: US Federal law restricts this device to sale only by or on the order of a physician.

Indications for Use: The Crit-Line IV System is used to non-invasively measure hematocrit, oxygen saturation and percent change in blood volume. The Crit-Line Clip (CLiC) measures hematocrit, percent change in blood volume and oxygen saturation in real time for application in the treatment of dialysis patients with the intended purpose of providing a more effective treatment for both the dialysis patient and the dialysis technician. Based on the data that the monitor provides, the clinician/nurse, under physician direction, intervenes (i.e. increases or decreases the rate at which fluid is removed from the blood) in order to remove the maximum amount of fluid from the dialysis patient without the patient experiencing the common symptoms of dialysis which include nausea, cramping and vomiting.

The Crit-Line IV is a Clinical Laboratory Improvement Amendment (CLIA) exempt instrumentation device.

US Patent Nos. 8,287,739, 8,130,369 and pending, comparable and/or related patents.

Table of Contents

Operating Instructions	1
Conventions	1
Compliance	2
General Warnings	3
Crit-Line IV System Overview	5
Crit-Line IV System	8
CLiC Verification Filter.....	9
Power Supply Adapter.....	10
Initial setup of the Crit-Line IV monitor	11
Setup Menu Screen.....	15
Selecting the Printer Port	17
Setting the date	18
Setting the Station ID	19
Selecting the Output Port	20
Setting the time	21
Selecting the displayed language.....	22
Changing the volume level	23
Auto vs Standard Run Mode	23
System Information Screen	25
CLiC Device Verification.....	27
Verifying accuracy on the CLiC	27
Field calibration on the CLiC	30
Connecting the Crit-Line Blood Chamber	33
Connecting the CLiC Device to the Crit-Line Blood Chamber	37
Using the Crit-Line IV monitor	39
Main Menu screen.....	39
Patient Run Menu Screen	41
Manually entering a Patient ID	43
Selecting Patient ID from a list	44
Patient Treatment Monitoring Screen.....	45
Reading Graphs on the Patient Treatment Monitoring Screen	46
The BV (Blood Volume) graph	49
The Sat (Oxygen Saturation) graph	49
The Hct (Hematocrit) graph.....	49
Menu Buttons	50







Setting an Event Marker.....	51
Setting the Blood Level (BV) Alert Level	52
Setting the O ₂ Alert Level	53
Ending a Patient Treatment Monitoring Session.....	54
Patient Run Option Menu Screen.....	55
History Menu Screen.....	57
Selecting a treatment from the list.....	59
DEMO Mode.....	60
Built-in session selection	60
Built-in session profiles.....	61
Replacing the CLiC device	65
Crit-Line IV Monitor Care.....	70
Cleaning and Disinfecting the Crit-Line IV monitor	70
CLiC Device Disposal.....	70
Troubleshooting, Alerts & Messages	71
Appendix	76
Product Improvement Policy	76
Warranty.....	76
Crit-Line IV Monitor and Spare Parts	77
Additional Information.....	77
Crit-Line IV Monitor Specifications	78
EMC Compliance	79
ZigBee Radio.....	79
Glossary	80
Index.....	81

This Page Intentionally Blank



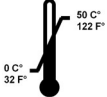

Operating Instructions

These instructions are for the operation of the Crit-Line IV monitor. The Crit-Line IV must only be operated by a trained operator according to these instructions.

Conventions

Symbol	Description
	Warning! A warning is a statement that identifies conditions or actions that could result in harm to the patient or operator. Warnings found in this manual outside of this section are designated with the warning symbol.
	Caution: A caution is a statement that identifies conditions or actions that could result in damage to the machine or injury to the operator.
	Note: Notes are advisory comments or recommendations regarding practices or procedures associated with the use of the Crit-Line IV device.
	Follow Instructions for Use.
	Manufacturer.
	Operating temperature (example).
	Radio Transmitter.
Button	A button refers to specific locations on the display screen that may be selected by the user to make changes to these display settings or parameters.

Compliance

Symbol	Description
	Clinical Laboratory Improvement Amendments Exempt. The use of the verification filter exempts the device from requiring periodic factory calibration.
	Type BF equipment for protection against electric shock.
	Magnetic Resonance unsafe.
258841 	CLiC Device: [CAN/CSA-C22.2 No. 60601-1:08] [ANSI/AAMI ES60601-1:2005] Certified By CSA for use in Canada and the U.S.
	Crit-Line IV Monitor is UL listed: MEDICAL-GENERAL MEDICAL EQUIPMENT AS TO ELECTRICAL SHOCK, FIRE AND MECHANICAL HAZARDS ONLY IN ACCORDANCE WITH CAN/CSA-22/2 No. 60601-1 (2008) ANSI/AAMI ES60601-1 (2005)

General Warnings



Warning: Read manual before use.

Warning: The Crit-Line IV monitor and Crit-Line in a Clip (CLiC) device described herein do not contain parts which can be serviced. No modification of this equipment is allowed.



Caution: The Crit-Line in a Clip (CLiC) device used by the Crit Line IV is a sensitive electro-optical device. Use special care when handling, storing, or cleaning the device. See the **Crit-Line IV Monitor Care** section (page 70)

Caution: Use only a stylus or fingertip to operate the touch screen of the Crit-Line IV monitor.

Caution: The Crit-Line IV Monitor is not intended to be connected to a public or hospital network.

Caution: Air bubbles trapped in the Crit-Line Blood Chamber or in the blood sample drawn for comparison of Hct and O₂ Saturation will cause poor correlation between the Crit-Line IV measurement and the reference standard.

Caution: The CLiC device calibration was verified using blood samples with serum sodium levels of 137 mEq/L. Changes in [Na⁺] affect the micro centrifuge-derived hematocrit values as follows: 1 unit decrease in “spun” hematocrit per 12 mEq/L increases in [Na⁺].

Abnormal sodium concentration may occur due to:

- Use of blood bank blood with sodium citrate (\cong 165 mEq/L)
- Use of normal saline (0.9% NaCl) as diluent (\cong 154 mEq/L)

Over hydration (<137 mEq/L)

- **Caution:** Hemolysis may affect hematocrit determination by reporting higher Hct values, although no changes in Crit-Line IV monitor measurements have been noted for plasma hemoglobin levels below 5gm%.
-

Caution: The Crit-Line IV monitor has not been tested for all possible blood conditions. Some of these conditions include sickle cell anemia, macrocytic anemia, and hyperlipidemia. Certain drugs and/or medications may cause idiopathic hyperlipidemias such as the prostaglandins (e.g. Alprostadil) and the intralipids given intravenously. These conditions may cause the hematocrit measurement to be inaccurate.

Caution: Factors such as food and water intake, and postural changes (e.g. recumbent versus sitting) may significantly affect the circulating blood volume during dialysis and can be observed

by the instrument. Nonetheless, the Crit-Line IV monitor only measures the changes occurring in the circulating blood volume and should not be confused with volumetric control devices which measure only the amount of fluid removed. Furthermore, while a patient's plasma refilling rate may vary depending on diet, state of health, medications, temperature, and posture, the Crit-Line IV monitor does not measure the rate of refilling. The Crit-Line IV monitor measures the change in total intravascular blood volume.



Note: The Crit-Line IV monitor is only a tool used to compliment a hemodialysis treatment. Operators must rely on their own clinical assessment of the patient to administer the treatment, as per the standard of care.

Note: If the Crit-Line IV monitor displays the message “Verify Accuracy” the CLiC device must be verified for accuracy before using it to monitor the treatment. To verify the CLiC device automatically, clip the device on its verification filter, which is attached to its cable.

Note: Hemoglobin oxygen saturation (O₂ Sat) values have a wide range depending on the type of vascular access and other factors. An O₂ Sat value from a Central Venous Catheter will typically be lower than a value from an arteriovenous fistula or graft.

Crit-Line IV System Overview

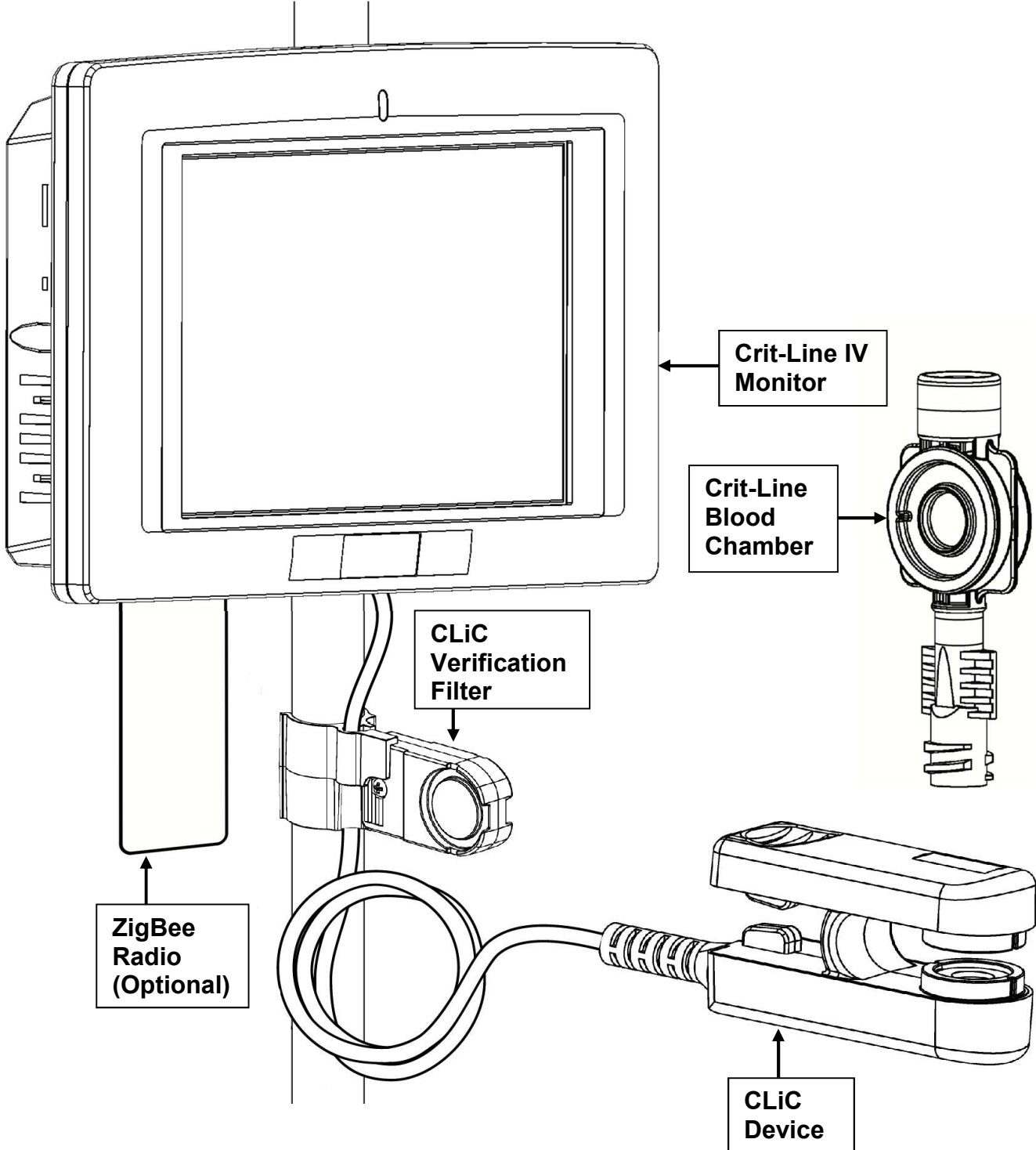

Crit-Line IV monitor — System View

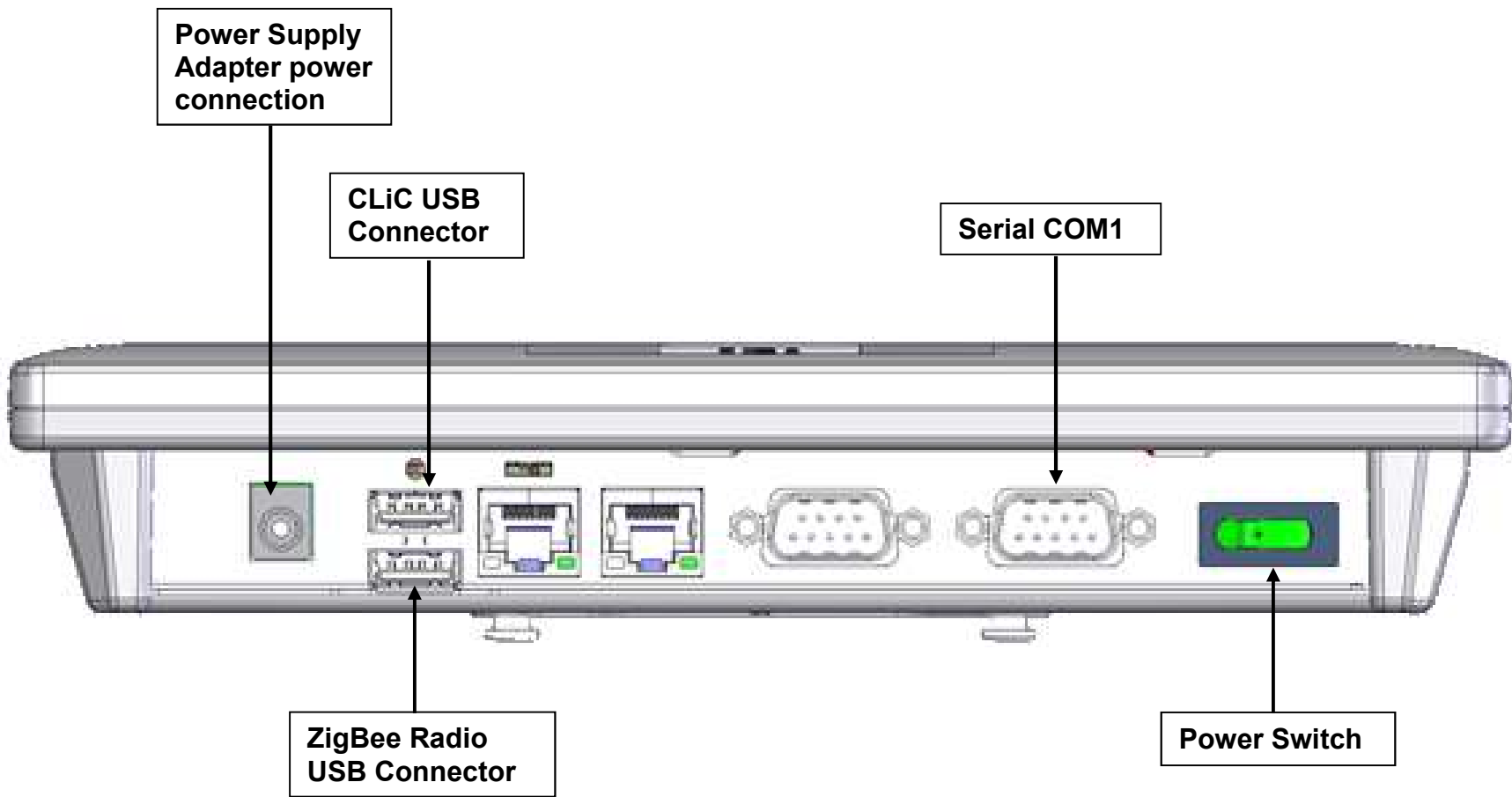

Crit-Line IV monitor — Bottom View — Model: POC-W07BT

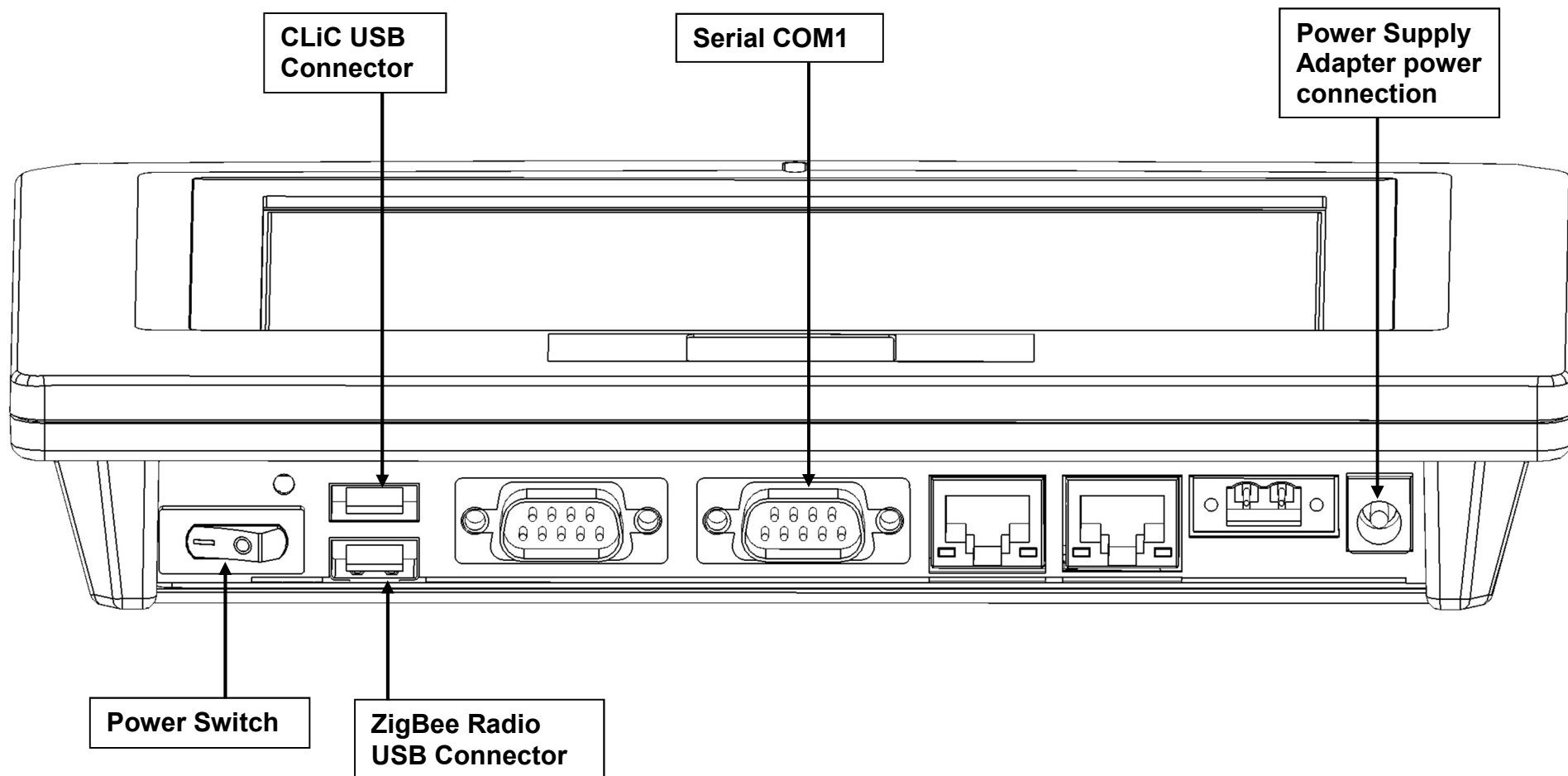

Crit-Line IV monitor — Bottom View — Model: IOVU-751R

Crit-Line IV System

The Crit-Line IV monitor is used to non-invasively measure a hemodialysis patient's hematocrit, oxygen saturation and calculate percent change in blood volume. These measurements occur in real time in order to provide a more effective treatment. Under the direction of a physician, the clinician/nurse can increase or decrease the ultrafiltration (UF) rate in order to remove the maximum amount of fluid without the patient experiencing the common dialysis related complications which include hypotension, nausea, cramping and vomiting.

Essential Performance

The essential performance for the Crit-Line IV system is to measure within the specified accuracy, Hematocrit (Hct) and Oxygen Saturation (O2 Sat).

Crit-Line IV Monitor

The Crit-Line IV monitor is a touch screen display device. The monitor mounts to the IV pole of the hemodialysis machine by means of the pole mount. The monitor is operated by touching buttons on the display. Menus are navigated by pressing buttons which allows the operator to do the following:

- Display the hematocrit, oxygen saturation and percent change in blood volume measurements in real time during a dialysis treatment.
- Review and print previous treatment data.
- Perform setup activities to control basic features of the Crit-Line IV monitor.

CLiC Device

The CLiC device connects via a cable with a USB connector to the port on the bottom left of the Crit-Line IV monitor.

The CLiC device is a sensor that when placed on the Crit-Line Blood Chamber, located between the arterial bloodline and the blood inlet port of the hemodialyzer, monitors the patient's hematocrit, oxygen saturation and percent change in blood volume. The CLiC device clips onto the Crit-Line Blood Chamber and shines light through the lens of the Crit-Line Blood Chamber onto a sensor on the opposite side of the blood chamber. This sensor detects the level of absorption and scattering of the light as it is transmitted through the patient's blood as it flows through the blood chamber.

CLiC Verification Filter

Each CLiC device is paired with a verification filter that is unique to that device. The CLiC Verification Filter is attached to the CLiC device's USB cable. The verification filter is used to periodically verify the accuracy of the CLiC device. The CLiC device should be securely clipped to the verification filter when it is not in use.



Note: When the CLiC device is stored on its verification filter, the Crit-Line IV monitor will automatically verify the accuracy of the CLiC device on a daily basis.

Note: If the CLiC device is not stored on the CLiC Verification Filter, the device must be verified at least once per month. If it has been more than 30 calendar days since the CLiC was last verified, the Crit-Line IV monitor will display an alert message informing the user that the CLiC needs to be verified.

Disposable Crit-Line Blood Chamber

The Crit-Line Blood Chamber is a sterile, disposable piece designed to ensure a consistent viewing area for the CLiC device sensor. This provides accurate, repeatable Hematocrit and oxygen saturation measurements.

ZigBee Radio (Optional)

The ZigBee Radio is used for printing data at the end of a patient treatment. The ZigBee Radio connects via a USB port on the bottom of the Crit-Line IV monitor and wirelessly sends data to another ZigBee Radio which is connected to a computer in the treatment area. This computer must have a copy of the Crit-Line Printer Software (Version 1.5 or later) loaded and running. The Crit-Line Printer Software receives the data and generates a report that is automatically sent to the default printer listed on the computer.



Note: Multiple Crit-Line IV monitors with ZigBee Radios can be used in one facility at the same time to print data wirelessly to a single computer in the treatment area.

Note: The Crit-Line IV monitor does not require the ZigBee Radio to be installed for monitoring a patient treatment.

Note: ZigBee is a specification for a suite of high-level communication protocols used to create personal area networks built from small, low-power digital radios. ZigBee is based on an IEEE 802.15 standard.

Power Supply Adapter

The Power Supply Adapter [P/N CL44300012] provides power to the Crit-Line IV monitor. It is plugged into the power supply connection on the bottom right side of the Crit-Line IV monitor and connects to a hospital grade power cord [P/N CL90000035] which is plugged into a grounded alternating current (AC) wall outlet.



Warning: Use only approved Power Supply Adapter provided by Fresenius Medical Care.

Warning: Keep the power supply adapter dry to prevent overheating or failure. Additionally, observe the following:

- Do not place the Power Supply Adapter in or near an area that is or has the potential to become wet.
- Do not use the Power Supply Adapter if it shows signs of corrosive buildup on any of the electrical connections.
- Do not use the Power Supply Adapter if it shows signs of damage such as frayed cords.
- Protect the Power Supply Adapter from being dropped.
- Connect the Power Supply Adapter to an earth grounded outlet



Note: The Crit-Line IV monitor does not have any backup power capabilities.

Note: If the Power Supply Adapter becomes disconnected from the Crit-Line IV monitor during a patient treatment, immediately reconnect the Power Supply Adapter. The Crit-Line IV monitor will give the option to continue monitoring the existing treatment.

Note: In the event of a power loss no data from an active patient treatment monitoring session is lost. If the power is restored within 15 minutes the Crit-Line IV monitor will give the option to continue monitoring the existing treatment.

Note: The preferred method to disconnect the device from building power is to remove the power supply cord from the wall receptical.

Initial setup of the Crit-Line IV monitor

Follow these basic steps to install the Crit-Line IV monitor in a clinical setting.



Note: Ensure that the following items are included in the package. If all items are not present, contact Customer Service (800) 546-5463.

- Crit-Line IV monitor with attached pole mount
- CLiC device with verification filter attached to USB cable
- ZigBee radio (Optional)
- Power Supply Adapter
- Power Cord

Note: LAN ports 1 and 2 and communications port COM 2 are inactive.

1 Attach Crit-Line IV monitor to IV pole

1. Remove the Crit-Line IV monitor from packaging.
2. Open the pole mount clamp by turning the knob counterclockwise (CCW) as shown.

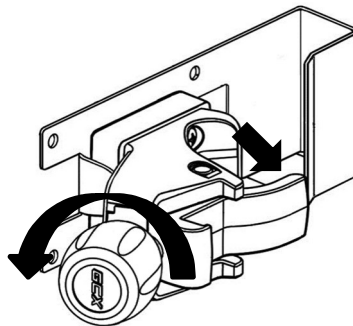

3. Position the pole mount clamp around the IV pole and turn the knob clockwise (CW) to tighten as shown.

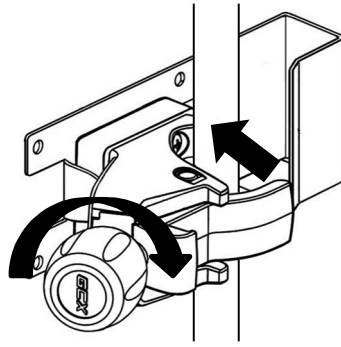

2 Connect CLiC device to Crit-Line IV monitor

1. Remove the CLiC device from packaging.
2. Gently push the USB connector on the CLiC cable into one of the USB sockets on the bottom of the monitor as shown below.

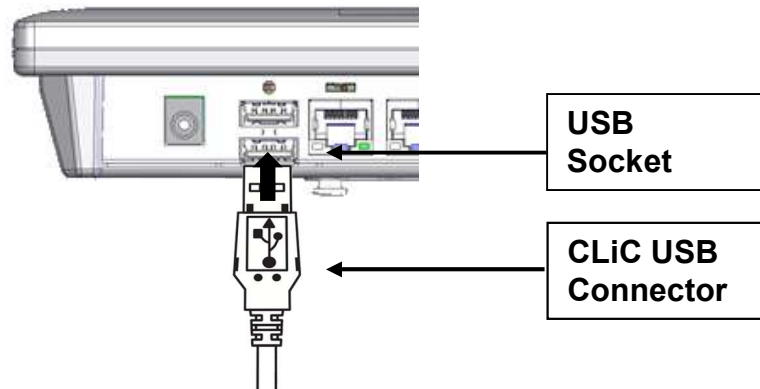

3. Attach the verification filter to the IV pole by grasping the verification filter near the base of the verification filter clip, and gently pushing it onto the IV pole. The verification filter clip will snap into place around the IV pole as shown.

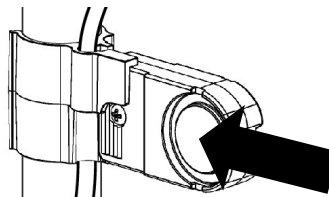

3 Connect ZigBee radio to Crit-Line IV monitor (Optional)

1. Remove ZigBee radio from packaging.
2. Insert the ZigBee radio into the Crit-Line IV monitor by gently pushing the USB connector on the ZigBee radio into one of the USB sockets on the bottom of the monitor as shown.



Note: If there is a plug in the LAN2 port preventing the proper insertion of the ZigBee radio then remove the plug from the LAN2 port prior to inserting the ZigBee radio into the USB port

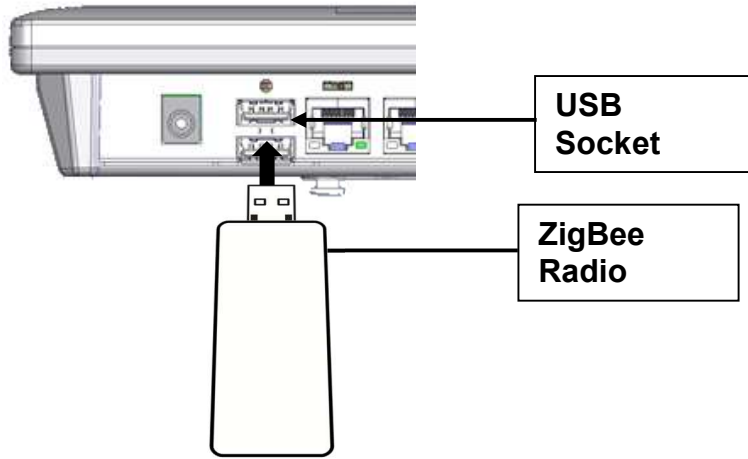

4 Connect Power Supply Adapter to Crit-Line IV monitor

1. Remove Power Supply Adapter and Power Cable from packaging.
2. Insert the Power Supply Adapter into the pole mount clamp with the attached cable facing upward as shown.

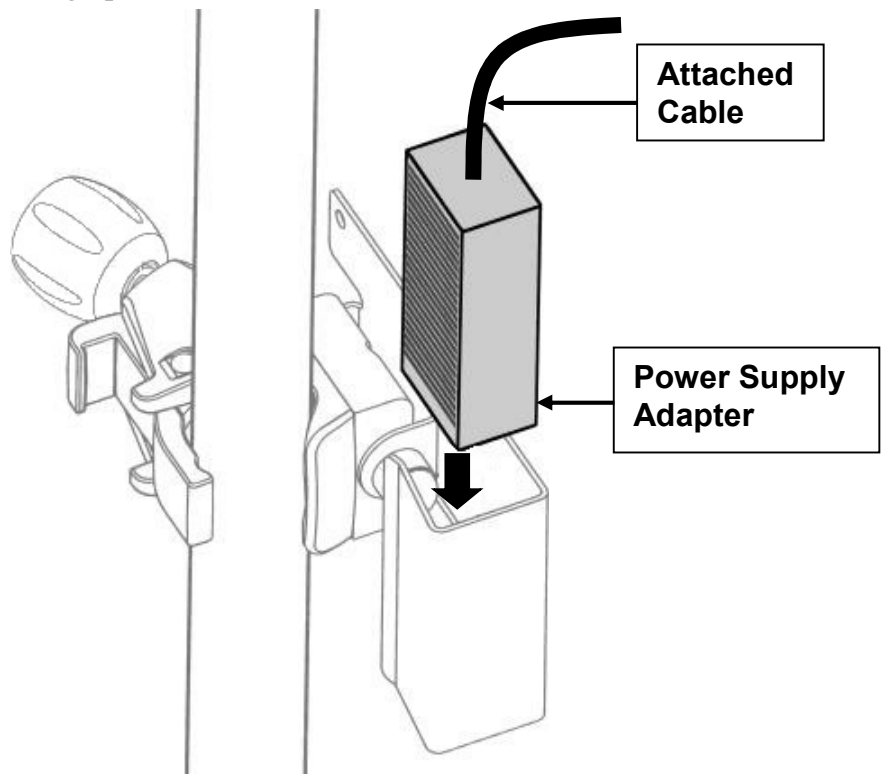

3. Insert the Power Cord into the Power Supply Adapter.
4. Insert the power supply plug into the Power Supply Adapter power connector on the bottom of the Crit-Line IV monitor as shown.

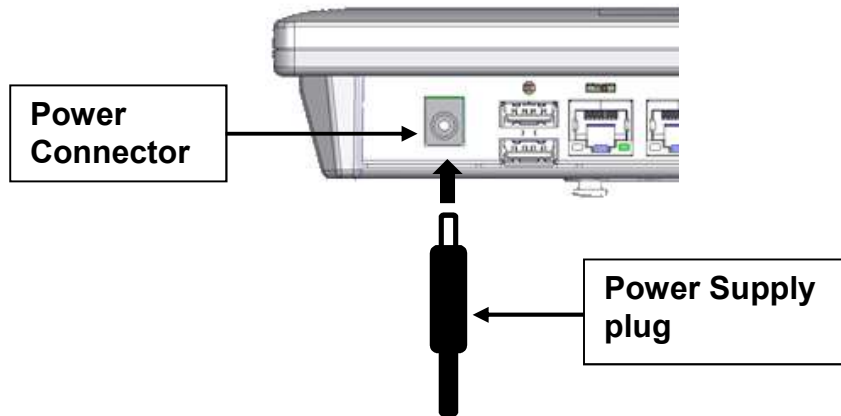

5. Plug the Power Cord into a grounded alternating current (AC) wall outlet.
6. Toggle the power switch. When the power is on, the green LED located at the top center of the device will be on.

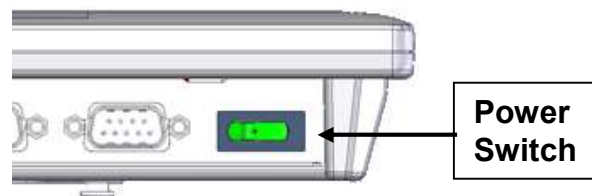

Note: Toggling the power switch when the device is on will initiate system shutdown.

Setup Menu Screen













The Setup Menu screen of the Crit-Line IV monitor

Setup Menu screen

The Setup menu is used to modify the system configuration of the Crit-Line IV monitor. This menu is shown on the facing page.

Listed below are the features available on this menu.

Feature	Description
	Printer Port button – Selects the output port for printing patient treatment data.
	Date button – Allows for changing the Crit-Line IV monitor date.
	Station ID button – Allows for the assignment of a Station ID to the Crit-Line IV monitor.
	Output Port button – Selects the output port for downloading patient treatment data.
	Time button – Allows for changing the Crit-Line IV monitor time.
	Language button – Allows for the selection of the display language for the Crit-Line IV monitor.
	Volume button – Allows for changing the volume level of the audio alerts.
 	<p>Auto Run button – Enables or disables the ability for the Crit-Line IV to automatically start/end a patient treatment monitoring session.</p> <p>When enabled, the Crit-Line IV monitor will initiate a patient treatment when a transition from the verification filter to blood is detected by the CLiC. The patient treatment monitoring is automatically terminated when a transition from blood to the verification filter is detected.</p>
	Return button – Returns to the Main Menu.

Selecting the Printer Port

Selecting the **Printer Port** button allows the user to select what output port to use for printing the patient treatment data. Follow these basic steps to select the printer port.

1 Press the Printer Port button

Once the **Printer Port** button is pressed, the printer port selection menu will appear.

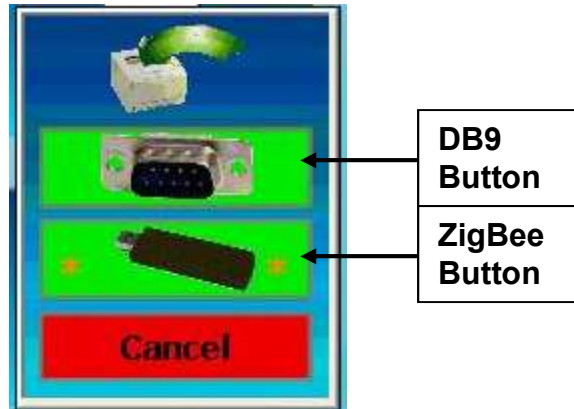

2 Make selection

Press one of the three buttons to select the printer port:

- **DB9** button – Selects com port 1 (COM1) as the printer port.
- **ZigBee** button – Selects the ZigBee radio as the printer port.
- **Cancel** button – Returns to the Setup Menu screen without changing the printer port.



Note: The current selection is shown with orange asterisks * on the button.

Note: The ZigBee radio will be selected as the printer port in most cases.

Setting the date

Selecting the **Date** button allows the date to be changed. Follow these basic steps to set the date.



1 Press the Date button

Once the **Date** button is pressed, the date selection menu will appear.



2 Make selection

Follow these basic steps to select a new date for the Crit-Line IV monitor.

1. Press the **Month**, **Day** or **Year** display field to select the item to change.
2. Press the yellow up  or down  button until the desired value is displayed.

3 Return

Press the **Ok** button to save the new date selected. Press the **Cancel** button to return to the Setup Menu without changing the date.

Setting the Station ID

Selecting the **Station ID** button allows the user to enter an identification number for the Crit-Line IV monitor. A two (2) character alpha-numeric ID can be entered. Follow these basic steps to enter a Station ID.

1 Press the Station ID button

Once the **Station ID** button is pressed, the Enter Station ID screen will appear.



2 Enter the Station ID

Enter the Station ID using the onscreen keypad. As characters are entered they will display in the top window.

3 Return

Once the Station ID has been entered, press the **Save** button to keep the Station ID or the **Cancel** button to discard the Station ID.

Selecting the Output Port

Selecting the **Output Port** button allows the user to select what output port to use for downloading patient treatment data. Follow these basic steps to select the output port.

1 Press the Output Port button

Once the **Output Port** button is pressed, the output port selection menu will appear.

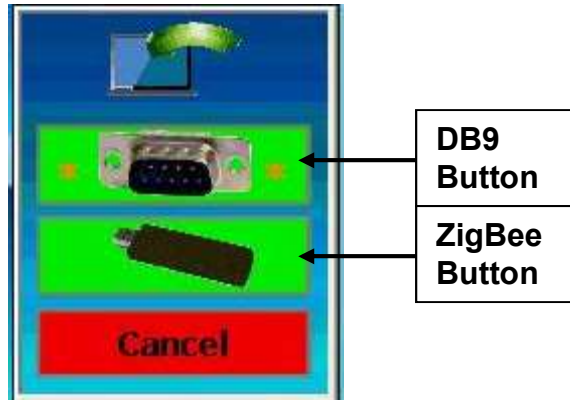

2 Make selection

Press one of the three buttons to select the output port:

- **DB9** button – Selects com port 1 (COM1) as the output port.
- **ZigBee** button – Selects the ZigBee radio as the output port.
- **Cancel** button – Returns to the Setup Menu screen without changing the output port.



Note: The current selection is shown with orange asterisks * on the button.

Note: COM1 will be selected as the output port in most cases.

Setting the time

Selecting the **Time** button allows the time to be changed. Follow these basic steps to change the time.



1 Press the Time button

Once the **Time** button is pressed, the time selection menu will appear.



2 Make selection

Follow these basic steps to select a new time for the Crit-Line IV monitor.

1. Press the **Hour**, **Minute** or **Second** display field to select the item to change.
2. Press the yellow up  or down  button until the desired value is displayed.

3 Return

Press the **Ok** button to save the new time selected. Press the **Cancel** button to return to the Setup Menu without changing the time.

Selecting the displayed language

Selecting the **Language** button allows the user to select what language the Crit-Line IV monitor will display. Follow these basic steps to select the displayed language.

1 Press the Language button

Once the **Language** button is pressed, the language selection menu will appear.



2 Make selection

Press the button of the desired language. The current selection is displayed at the top of the language selection menu.

3 Return

Press the **Ok** button to save the new language selection. Press the **Cancel** button to return to the Setup Menu without changing the language.

Changing the volume level

Selecting the **Volume** button allows the user to change the volume level of the audible alerts. Follow these basic steps to change the volume.

1 Press the Volume button

Once the **Volume** button is pressed, the volume selector will appear.



2 Change volume

Press the yellow up ▲ or down ▼ button to increase or decrease the volume and play an audio tone at the current volume. The current volume level is also displayed as a blue bar graph to the left of the yellow buttons.

3 Return

Press the **Ok** button to save the new volume selection. Press the **Cancel** button to return to the Setup Menu without changing the volume.

Auto vs Standard Run Mode

For the Crit-Line IV to indicate an accurate change in blood volume during a Patient Run, it is necessary for the patient's first measured Hematocrit to be accurate and stable. Residual saline from pretreatment priming of the bloodline will cause the initial Hematocrit reading to be low or unstable as it mixes with the patient's blood at start of treatment.



Note: In Standard Run Mode (**Auto Run** disabled) the clinician is required to wait at least five (5) minutes after patient blood is introduced into the dialysis circuit before beginning a Crit-Line Patient Run. This wait ensures any saline residuals are fully mixed into the blood and the measured Hematocrit is accurate and stable.

In Standard Mode (**Auto Run** disabled) actions associated with starting and terminating a patient treatment monitoring session requires user input through touch screen selections of [**Start Run**] or [**End Run**].

To automate the process of starting and ending a treatment session the Crit-Line IV features an Auto Run Mode. When Auto Run is enabled, a Patient Run will start automatically after the following sequence of events occurs:

1. The CLiC is first connected to the Verification Filter
2. The CLiC is next connected to a blood bearing CLiC blood chamber
3. The Crit-Line IV senses that a stable Hematocrit level has been achieved i.e. saline prime is fully mixed into the patient's blood as indicated by a sufficient period of either flat or slightly negative slope to the monitored Hematocrit

When Auto Run is enabled, an active Patient Run treatment monitoring session will automatically end - without having to select the [**End Run**] button - when the CLiC is removed from the CLiC blood chamber and placed on the verification filter.



Note: Neither Standard Mode nor Auto Run Mode will automatically generate a Patient ID. Patient IDs must be entered by the user.

System Information Screen

Time: 04/26/2018 13:42:59
Unit ID: SA301233 V2.1
Station ID: 12
CLiC ID: 1C42M140149 V2.02 Jun 26 2014
Filter ID 2KPU
CLiC Status: Ok
Last Verified: 04/26/2018
Printer port = USB Radio
Data port = DB9 COM1
Technical Service # 800-546-5463
Customer Service # 800-546-5463



The System Information screen of the Crit-Line IV monitor

Crit-Line IV monitor system information screen.

Pressing the **About** button from the Main Menu screen displays the system information screen. This screen shows basic monitor settings as well as the status of the attached CLiC device. This screen is shown on the facing page.

Listed below are the features available on this screen.

Feature	Description
Time	Displays the current date and time. The date is in MM/DD/YYYY format. The time is in HH:MM:SS format.
Unit ID	Displays the Crit-Line IV monitor serial number and software version.
Station ID	Displays the Crit-Line IV monitor station identification number.
CLiC ID	Displays the serial number, software version and software date of the attached CLiC device.
Filter ID	Displays the verification filter identification value. This value must match the value located on the verification filter.
CLiC Status	Displays the operational status of the attached CLiC device. There are three (3) possible messages: <ul style="list-style-type: none"> • OK – The CLiC device is operating normally. • Fail – The CLiC device has either failed a verification of accuracy or is nonfunctional and cannot be used for patient treatment monitoring. • Not Responding – The CLiC device is not communicating with the Crit-Line IV monitor. Check the USB connection of the CLiC to the Crit-Line IV monitor.
Last Verified	Displays the date of the last successful CLiC verify accuracy. This is also displayed on the Main Menu screen under the Verify Accuracy button.
Printer Port	Displays the printer port selection.
Data Port	Displays the download data port selection
Technical Service #	Displays the technical service telephone number.
Customer Service #	Displays the customer service telephone number
	Return button – Returns to the Main Menu.

CLiC Device Verification

Verifying accuracy on the CLiC

Selecting the **Verify Accuracy** button from the Main Menu screen allows the user to perform a manual verification of accuracy on the CLiC.



Note: In most cases, it is not necessary to perform a manual verification. If the sensor clip is placed onto the verification filter, the Crit-Line IV monitor will automatically perform a verification test once per day and the date of the most recent successful verification will be displayed below the **Verify Accuracy** button.

Note: The user cannot access the Patient Run Menu screen until a successful verification has taken place.

Note: If the verification fails two or more times, the option is given to perform a field calibration.

Follow these basic steps to manually verify accuracy.

1 Place CLiC on Verification Filter

1. Hold the CLiC device such that one side is held by the index finger and other side held by the thumb. Squeeze the clip to spread the sensor elements apart.
2. Place the CLiC device over the verification filter such that the sensor elements cover the middle portion of the verification filter.
3. Release the clip to allow the sensor elements to seat on the verification filter.
4. Make certain that the CLiC device has locked securely into place on the verification filter by noting the audible and tactile click.

2 Press the Verify Accuracy button

Once the **Verify Accuracy** button is pressed, the following screen will appear. This screen will remain for approximately ten (10) seconds.

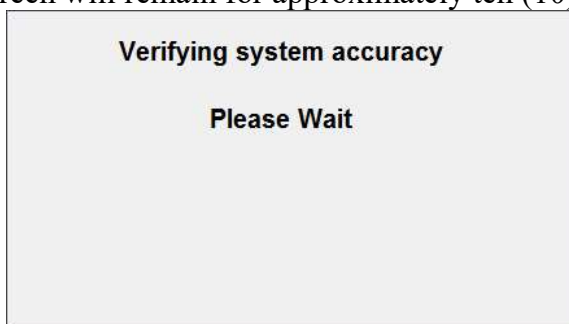

3 Verify passed

If successful, the following screen will appear. Press the **Ok** button to return to the Main Menu screen. At this point the verification is complete and no further action is required.



4 Verify failed

If the verification failed, the following screen will appear.

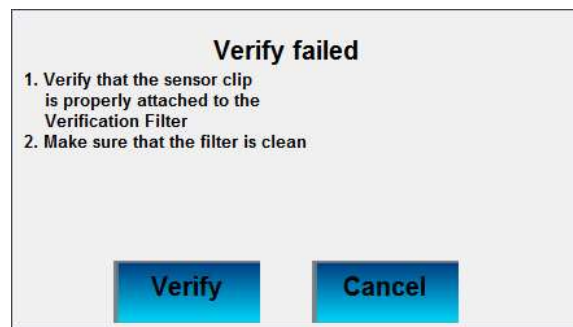

Follow these basic steps to address a failed verification of accuracy.

1. Ensure that the CLiC is properly seated on the verification filter. Refer to step **1 Place CLiC on Verification Filter** on the **previous page** for detailed instructions on proper placement of CLiC on the verification filter.
2. Ensure that the verification filter is clean of any foreign material and that the surface is not scratched or damaged.

3. Press the **Verify** button to repeat the verification of accuracy. If successful, the following screen will appear. Press the **Ok** button to return to the Main Menu screen. At this point the verification is complete and no further action is required.



4. If the verification fails again, the following screen will appear.

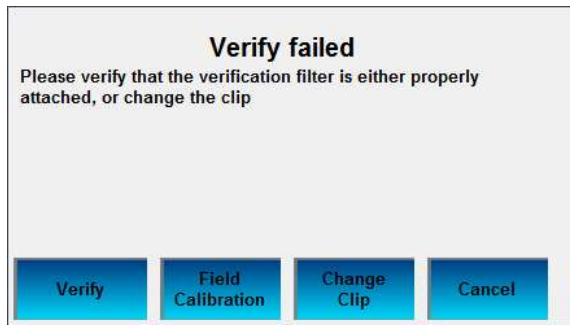

At this point the user may do one of the following:

- Repeat the verification. Refer to step **4 Verify failed** sub steps 1 through 3 on the previous page.
- Perform a field calibration. Refer to the **Field calibration on the CLiC** section below.
- Change the CLiC device. Refer to the **Replacing the CLiC device** section (page 65).
- Cancel the verification process by pressing the **Cancel** button.



Note: If the operator chooses to cancel a failed verification process the device will not be available for patient treatment monitoring.

Field calibration on the CLiC

Selecting the **Field Calibration** button from the Verify failed menu screen allows the user to perform a field calibration on the CLiC.



Note: This option will only be made available if the verification of accuracy fails multiple times.

Follow these basic steps to perform a field calibration.

1 Press the **Field Calibration** button

Once the **Field Calibration** button is pressed, the following screen will appear.

The image shows a screenshot of a 'Field Calibration' screen. At the top, the title 'Field Calibration' is centered. Below the title, there are two lines of text: 'Enter the filter ID located at the base of the verification filter' and 'Press the Filter ID button to complete this process'. At the bottom of the screen, there are two blue buttons with white text: 'Filter ID' on the left and 'Cancel' on the right.

2 Press the Filter ID button

Once the **Filter ID** button is pressed, the Enter Filter ID screen will appear.

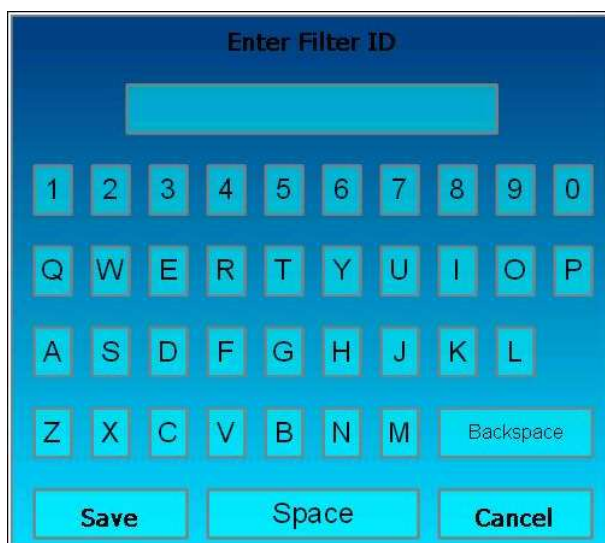

1. Enter the verification filter ID using the onscreen keypad. As characters are entered they will display in the top window. The filter ID is located in the middle of the verification filter, as shown.

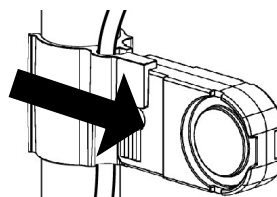

2. Once the verification filter ID has been entered, press the **Save** button.

3 Press the Ok button

Once the **Ok** button is pressed, a verification of accuracy will be performed as described in the **Verifying accuracy on the CLiC** section.



Note: If the verification of accuracy continues to fail, the CLiC is no longer suitable for clinical use and should be replaced.

This Page Intentionally Blank

Connecting the Crit-Line Blood Chamber

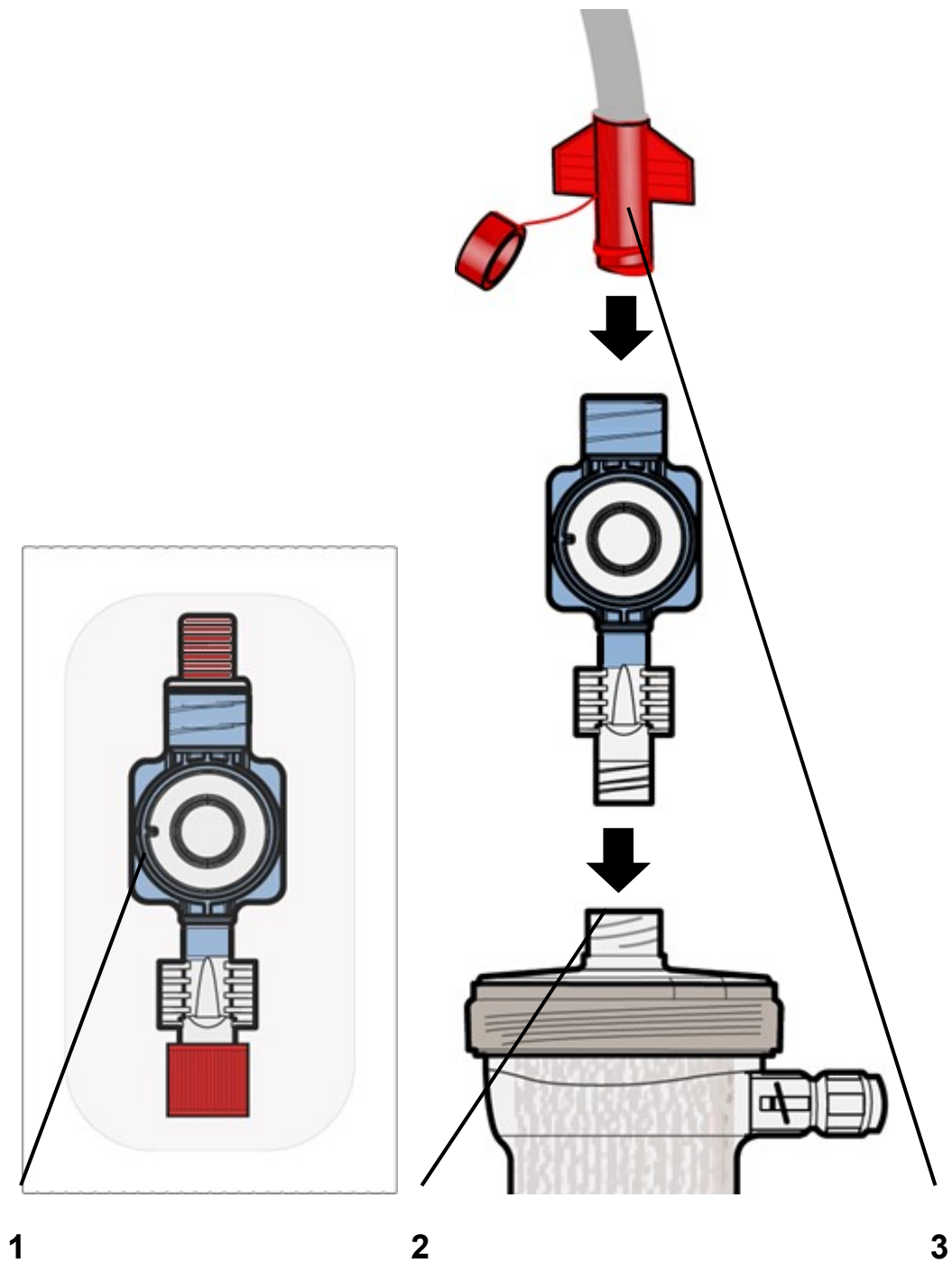

Connecting the Crit-Line Blood Chamber

Follow these basic steps to attach the disposable Crit-Line Blood Chamber (P/N CL10041021) to the dialyzer during the extracorporeal bloodline setup before priming the bloodlines.



Note: The Crit-Line Blood Chamber is intended for single use only. A new unopened sterile blood chamber must be used for each monitoring session.

1 Inspect Crit-Line Blood Chamber and packaging

Inspect the Crit-Line Blood Chamber and its sterile package prior to use. Refer to the blood chamber package label to ensure that the blood chamber sterilization has not expired.



Warning: Do not use the Crit-Line Blood Chamber if its package has been opened or its sterility has otherwise been compromised prior to use. The viewing area of the disposable blood chamber should be kept clean and free of obstruction.

2 Connect Crit-Line Blood Chamber to dialyzer

Remove the blood chamber from its sterile package and aseptically attach it to the arterial port of the dialyzer (as shown on the facing page). Make sure the connection is tight. PUSH and TWIST. Use the wings and not the lens to tighten.

3 Continue setting up the bloodlines

Continue to set up the bloodlines per instructions provided by the hemodialysis machine's operators manual.

When connecting the arterial bloodline to the Crit-Line Blood Chamber (not the dialyzer), hold the Crit-Line Blood Chamber securely in one hand and aseptically attach the dialyzer end of the arterial bloodline with the other hand. Be careful that you do not cross-thread the connection. The connection of the Crit-Line Blood Chamber to the arterial bloodline must not leak.

Make sure that no air is in the Crit-Line Blood Chamber after priming. Any air present in the Crit-Line Blood Chamber may cause the hematocrit and oxygen saturation readings to be inaccurate.



Note: To prevent air bubbles from entering the blood chamber, ensure that all connections to the CLiC Blood Chamber are tight.

Note: To detect air bubbles, look at the viewing area of the CLiC Blood Chamber. If air bubbles are present once blood has entered the extracorporeal circuit, they will be clearly visible. If no air bubbles are present, the entire viewing area of the CLiC Blood Chamber will be filled with fluid.

Note: To remove air bubbles, gently tap the chamber until all air bubbles exit the viewing area of the chamber. Vertical orientation of the CLiC blood chamber will expedite this process.

This Page Intentionally Blank

Connecting the CLiC Device to the Crit-Line Blood Chamber

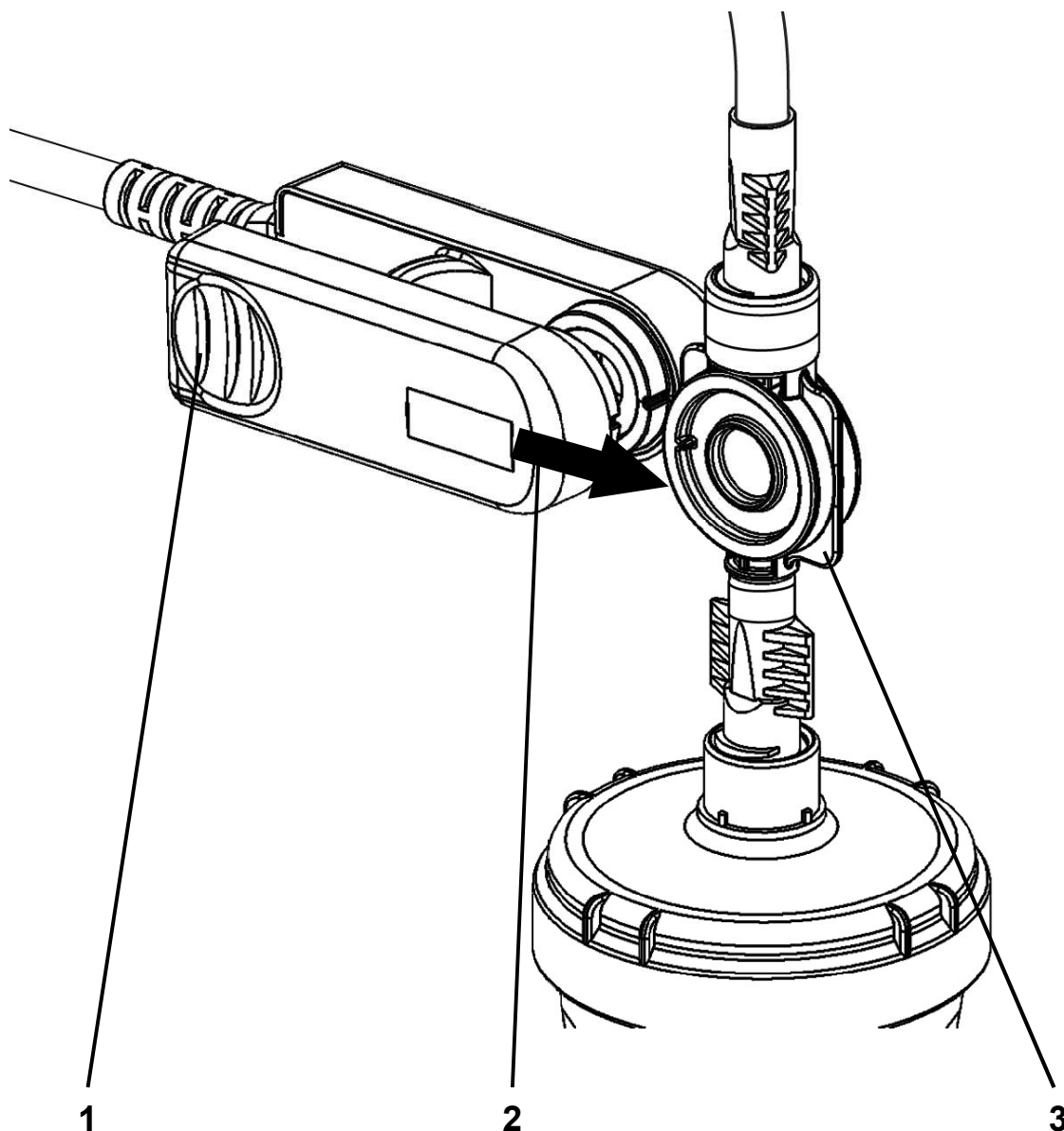

Connecting the CLiC Device to the Blood Chamber

Follow the steps below to clip the CLiC device to the Crit-Line Blood Chamber (P/N CL10041021) before connecting to the patient's vascular access:

1 Pinch open the CLiC device

Hold the CLiC device such that one side is held by the index finger and other side held by the thumb. Squeeze the clip to spread the sensor elements apart.

2 Clip CLiC device on Blood Chamber



Caution: Before attaching the CLiC device, check carefully for leaks at the connections between the blood chamber and the dialyzer and the blood chamber and the arterial blood line. Improper attachment of the arterial bloodline to the Crit-Line Blood Chamber can cause blood or saline to leak onto and into the CLiC device. This can damage the CLiC device.



Note: Make sure that the CLiC device is plugged into a USB port located on the bottom of the Crit-Line IV monitor.

1. Place the CLiC device over the Crit-Line Blood Chamber so that the optical sensor covers the lens of the Crit-Line Blood Chamber.
2. Release the clip to allow the optical sensor to seat on the viewing area of the Crit-Line Blood Chamber.
3. Make certain that the CLiC device has locked securely into place on the Crit-Line Blood Chamber by noting the audible and tactile click.
4. Ensure that the CLiC device is perpendicular to the top of the dialyzer and cannot be easily rotated up or down while attached to the blood chamber to ensure its proper placement.



Note: Make sure that the CLiC device is properly in place before starting the treatment. If the CLiC device is not properly seated on the Crit-Line Blood Chamber, the accuracy of the hematocrit and oxygen saturation readings may be adversely affected.

Using the Crit-Line IV monitor

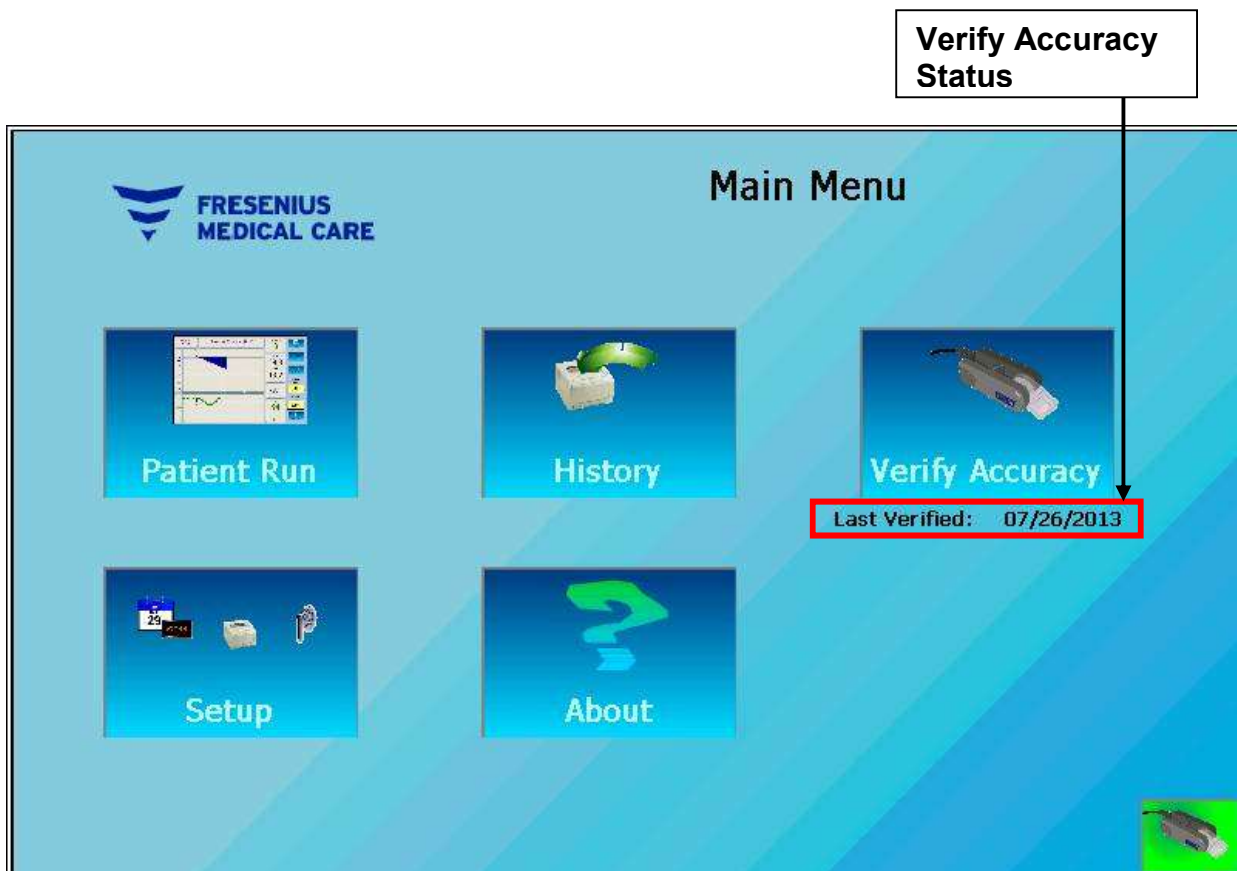







The Main Menu screen of the Crit-Line IV monitor

Main Menu screen

When the Crit-Line IV monitor is first turned on, the Main Menu screen will appear. This screen is shown on the facing page.

Listed below are the features available on this menu.

Feature	Description
 Patient Run	Patient Run button – Activates the Patient Run menu.
 History	History button – Activates the Patient History menu.
 Verify Accuracy	Verify Accuracy button – Initiates a manual verification of accuracy. The last successful verification date is shown below the button in bold black print.
 Setup	Setup button – Activates the Setup menu.
 About	About button – Activates a display showing system information.
	CLiC Status indicator – Displays the operational status of the attached CLiC device. There are five (5) possible states: <ul style="list-style-type: none"> • Passed Verification with Verification Filter – The green background indicates that the CLiC device has passed a verification of accuracy and is operating normally. The CLiC is shown attached to the Verification Filter to indicate that the CLiC device detects the Verification Filter. • Passed Verification without Verification Filter – The green background indicates that the CLiC device has passed a verification of accuracy and is operating normally. The CLiC is shown without the Verification Filter to indicate that the CLiC device does not detect the Verification Filter. • Failed Verification with Verification Filter – The orange background indicates that the CLiC device has not passed a verification of accuracy and is not ready for use. The CLiC is shown attached to the Verification Filter to indicate that the CLiC device detects the Verification Filter. • Failed Verification without Verification Filter – The orange background indicates that the CLiC device has not passed a verification of accuracy and is not ready for use. The CLiC is shown without the Verification Filter to indicate that the CLiC device does not detect the Verification Filter. • Not Responding – The blue background and red “No” symbol indicates that the CLiC is not plugged into the USB port on the bottom of the Crit-Line IV monitor.

Patient Run Menu Screen

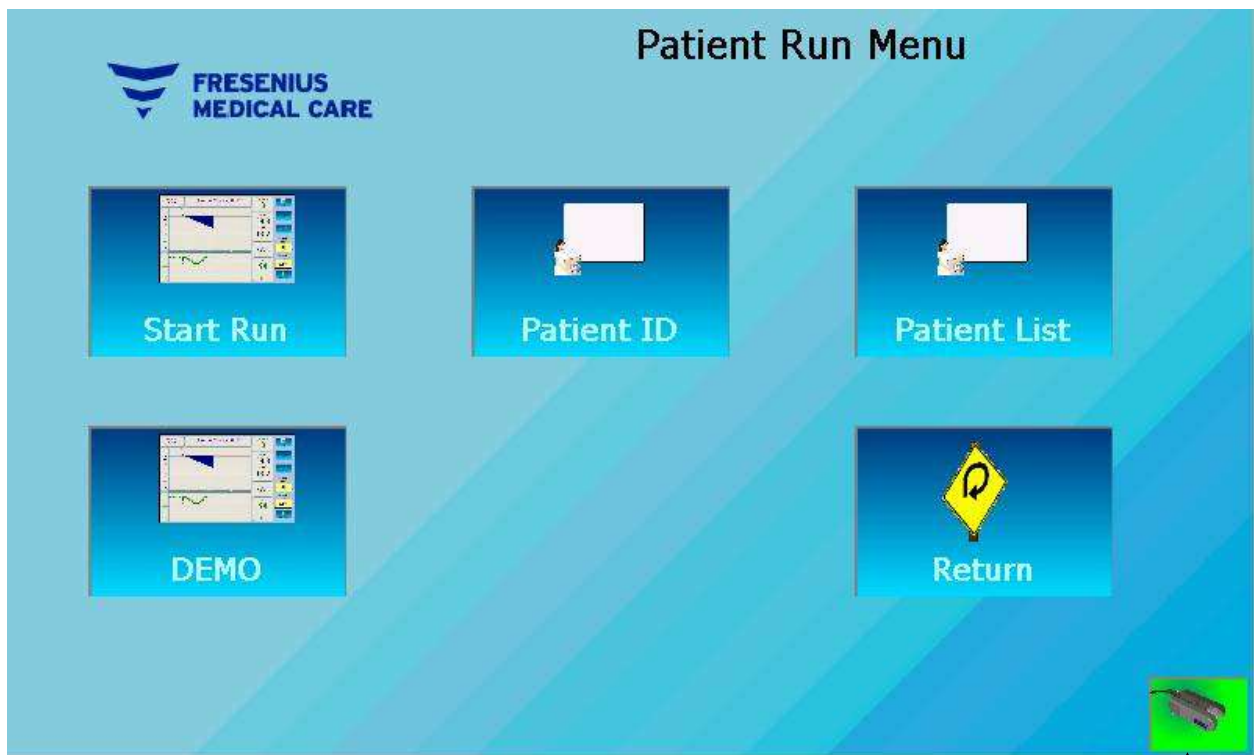





The Patient Run Menu screen of the Crit-Line IV monitor

CLiC Status Indicator

Patient Run Menu screen

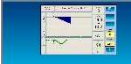
The Patient Run menu is used for entering patient ID information and initiating patient treatment monitoring. This menu is shown on the facing page.

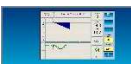
Listed below are the features available on this menu.

Feature	Description
 Start Run	Start Run button – Initiates patient treatment monitoring.
 Patient ID	Patient ID button – Allows for manually entering a Patient ID.
 Patient List	Patient List button – Allows for the selection of a Patient ID from a list.
 DEMO	DEMO Run button – Initiates demonstration patient treatment monitoring. The demonstration treatment is a built-in four hour treatment generated at the rate of one minute per second.
 Return	Return button – Returns to the Main Menu.
	CLiC Status indicator – Displays the operational status of the attached CLiC device. There are five (5) possible states: <ul style="list-style-type: none"> • Passed Verification with Verification Filter – The green background indicates that the CLiC device has passed a verification of accuracy and is operating normally. The CLiC is shown attached to the Verification Filter to indicate that the CLiC device detects the Verification Filter. • Passed Verification without Verification Filter – The green background indicates that the CLiC device has passed a verification of accuracy and is operating normally. The CLiC is shown without the Verification Filter to indicate that the CLiC device does not detect the Verification Filter. • Failed Verification with Verification Filter – The orange background indicates that the CLiC device has not passed a verification of accuracy and is not ready for use. The CLiC is shown attached to the Verification Filter to indicate that the CLiC device detects the Verification Filter. • Failed Verification without Verification Filter – The orange background indicates that the CLiC device has not passed a verification of accuracy and is not ready for use. The CLiC is shown without the Verification Filter to indicate that the CLiC device does not detect the Verification Filter. • Not Responding – The blue background and red “No” symbol indicates that the CLiC is not plugged into the USB port on the bottom of the Crit-Line IV monitor.

Manually entering a Patient ID

Selecting the **Patient ID** button allows the user to enter a patient specific identification. Up to a nineteen (19) character alpha-numeric ID can be entered. Follow these basic steps to manually enter a patient ID.

1 Press the Patient ID button

Once the **Patient ID** button is pressed, the Patient ID entry screen will appear.

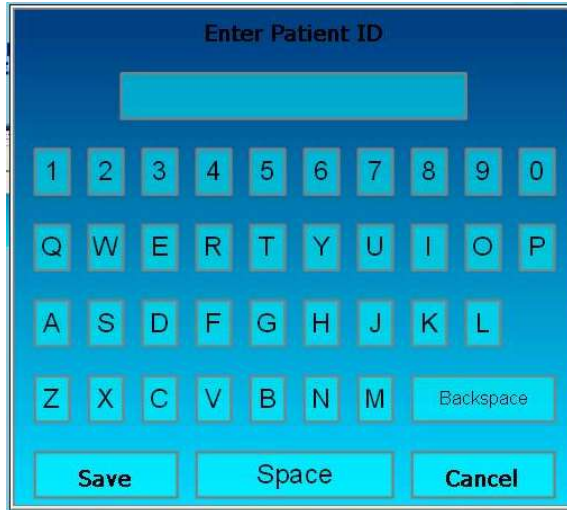

The screenshot displays a blue-themed interface titled "Enter Patient ID". At the top, there is a white rectangular input field. Below it is a numeric keypad with buttons for digits 1 through 0. The next three rows contain alphabetic keys: the first row has Q, W, E, R, T, Y, U, I, O, P; the second row has A, S, D, F, G, H, J, K, L; and the third row has Z, X, C, V, B, N, M, and a "Backspace" button. At the bottom of the keypad are three larger buttons labeled "Save", "Space", and "Cancel".

2 Enter the Patient ID

Enter the Patient ID using the onscreen keypad. As characters are entered they will display in the top window.

3 Return

Once the Patient ID has been entered, press the **Save** button to keep the Patient ID or the **Cancel** button to discard the Patient ID.

Selecting Patient ID from a list

Selecting the **Patient List** allows the user to view the patient ID list for all patients ID's that have been entered into the Crit-Line IV monitor within the previous thirty (30) calendar days. Follow these basic steps to select a patient ID from the list.



Note: Patient treatment monitoring sessions are stored in the Crit Line IV monitor for thirty (30) calendar days.

Note: Session data will be deleted automatically 30 calendar days after the date it was stored.

1 Press the Patient List button

Once the **Patient List** button is pressed, the patient ID selection screen will appear.



2 Select Patient ID from list

Use the up and down arrows to navigate the list of patient IDs. Then select the patient ID for the upcoming treatment by pressing the patient ID. The selected patient ID will be displayed in the top window.

3 Return

Once the patient ID has been chosen, press the **Select** button to confirm the entry. Press the **Cancel** button to return to the Patient Run menu without selecting a patient ID.

Patient Treatment Monitoring Screen

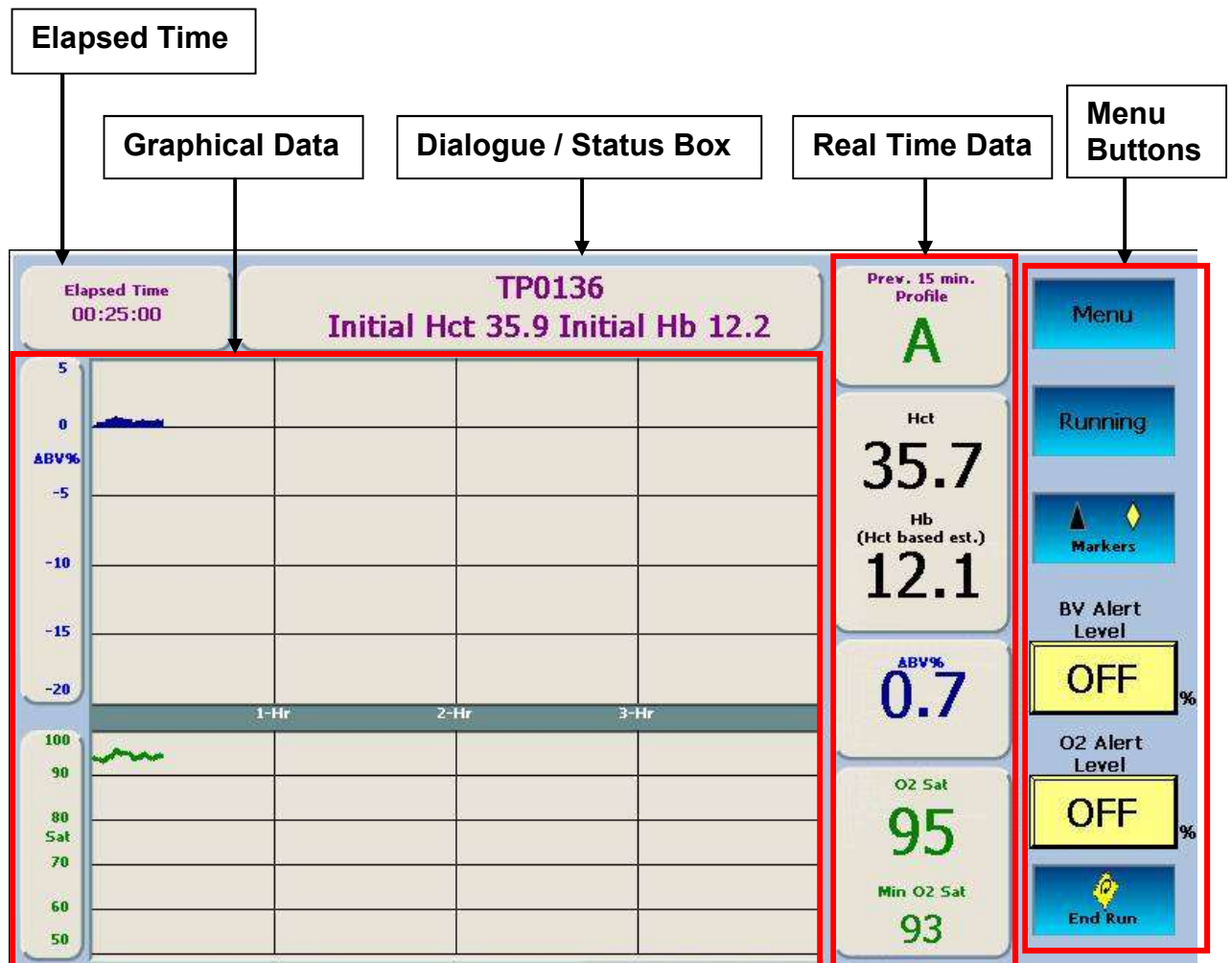

The Patient Treatment Monitoring screen showing BV and O₂ Sat graphs

Patient Treatment Monitoring screen

The Patient Treatment Monitoring screen is used for monitoring the patient's hematocrit, oxygen saturation and percent change in blood volume in real time during a dialysis treatment.

Reading Graphs on the Patient Treatment Monitoring Screen

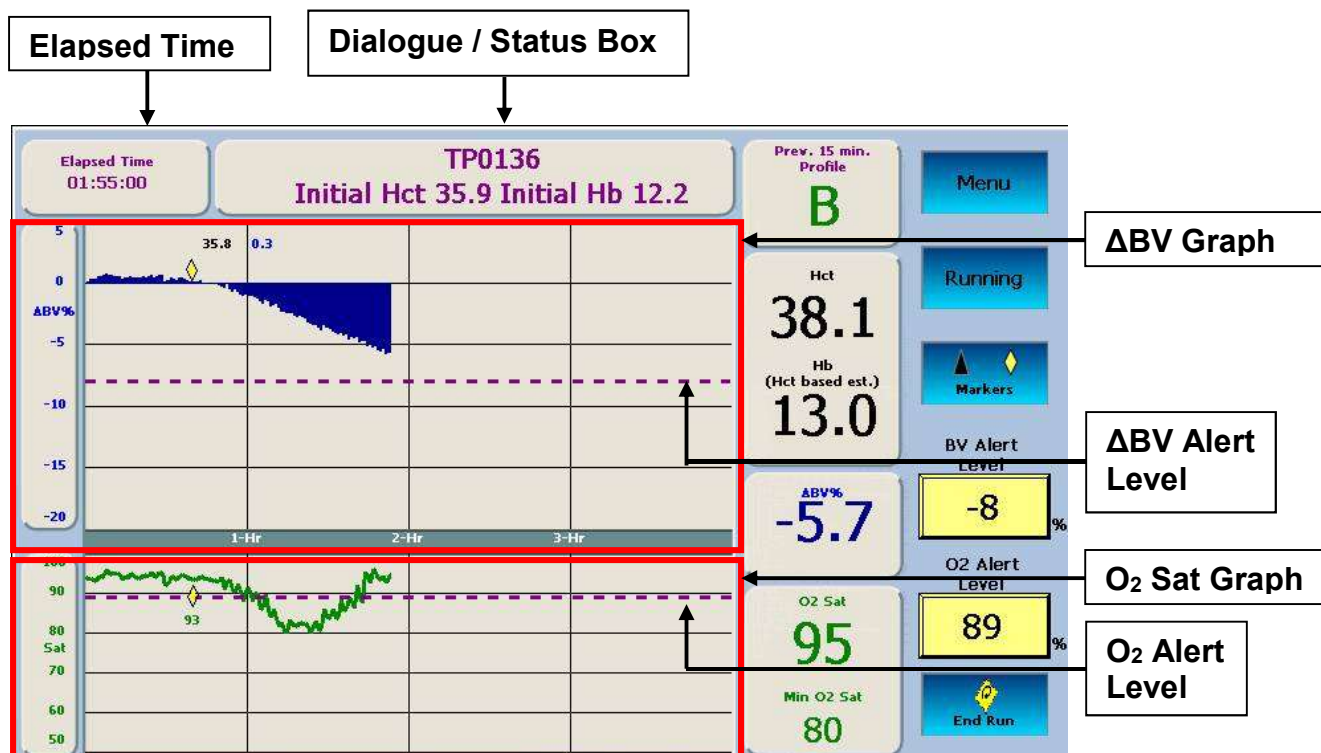

The Patient Treatment Monitoring screen showing BV and O₂ Sat graphs with markers

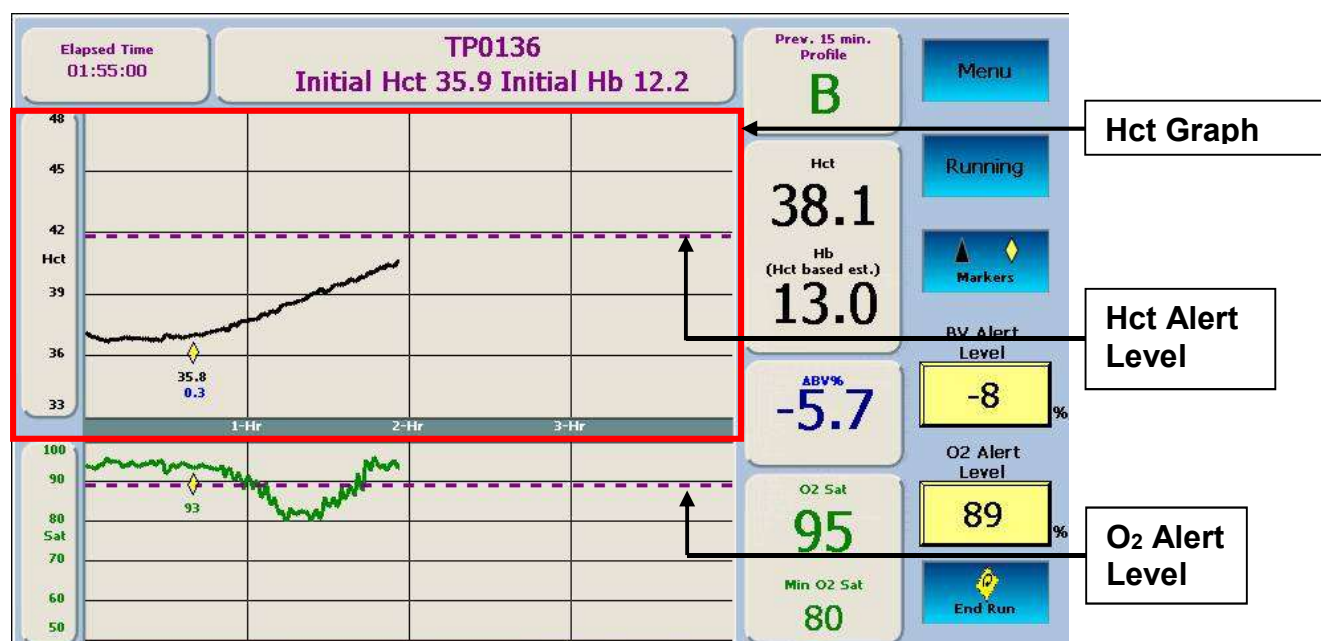

The Patient Treatment Monitoring screen showing Hct and O₂ Sat graphs with markers

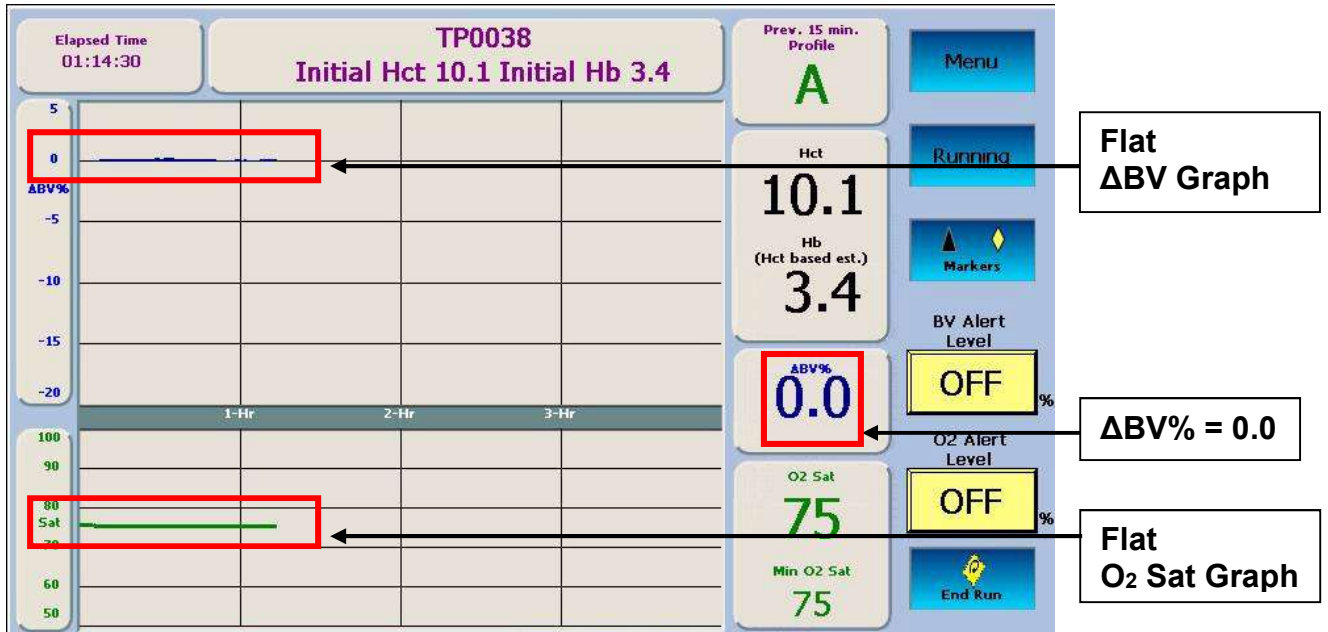

The Patient Treatment Monitoring screen with the CLiC device attached to the Verification Filter showing flat BV and O₂ Sat graphs.



Note: If the Patient Treatment Monitoring session is conducted with the CLiC device attached to the Verification Filter, there will be no variation in the displayed values at any time during the course of the monitoring session. This will produce flat Δ BV, Hct and O₂ Sat graphs as a result of the Verification Filter providing constant values.

Note: If this condition is observed, and patient treatment monitoring on blood was intended, do the following:

- Properly place the CLiC device onto the patient's blood chamber.



- Press the  button to activate the **Patient Run Option Menu** screen.









- Press the  button to restart the Patient Treatment Monitoring session.





Reading Graphs on the Patient Treatment Monitoring screen

The Patient Treatment Monitoring screen can display either Blood Volume (Δ BV%) or Hematocrit (Hct) on the upper graph depending on display selection. The display selection is made from the **Patient Run Option** menu. On the lower graph, the Oxygen Saturation (O₂ Sat) graph will always display. The BV and O₂ Sat graphs are displayed by default. These screens are shown on the previous pages.

Graphing of the data begins after the Crit-Line IV monitor senses blood and the hematocrit has been stable for sixty seconds. The graphs may be resized to display a larger range during the treatment depending on the min/max values.

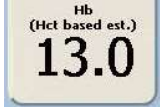
Listed below are features common to all graph displays:

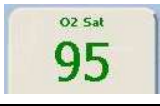
Feature	Function
	Elapsed Time – The elapsed time from the beginning of the treatment. The elapsed time does not include any time during which the treatment is paused.
	Initial Hct– The initial (starting) hematocrit (Hct) value is recorded along with the first data point when graphing begins.
	Initial est. Hb – The initial (starting) estimated hemoglobin (Hb) value is recorded along with the first data point when graphing begins. It is calculated based on the hematocrit reading.
	Patient ID – Refers to the Patient ID assigned to the patient treatment monitoring session. The PID will only display if it was entered.
 	<p>Blood volume (BV) change profile – Displays one of the following:</p> <ul style="list-style-type: none"> • Establishing Profile – The profile is established over the first 15 minutes of data when the treatment is initially started or if the treatment resumes. No profile is shown during this time. • Previous 15 Minute Profile – The current profile as computed over the previous 15 minutes of data. The profile may be: <ul style="list-style-type: none"> A BV change is less than or equal to -3% per hour (default) B BV change is more than -3% and less than or equal to -6.5% per hour C BV change exceeds -6.5% per hour • No Profile – No profile is shown while a treatment is paused. Once resumed, a new profile will be established.
	Current Hematocrit (Hct) value.

	<p>Current estimated Hemoglobin (Hb) value calculated from the current Hematocrit using the following equation: $Hb = Hct/3.1046$</p>
	<p>Blood Volume Change – The percent change in blood volume since the start of the treatment. The BV change value is calculated from the following equation: $\Delta BV\% = [(Hct\ initial/Hct\ current) - 1] * 100.$</p>
	<p>Current Oxygen Saturation value.</p>
	<p>Minimum Oxygen Saturation – The minimum oxygen saturation value over all data points.</p>

The BV (Blood Volume) graph



Note: The BV graph is the default upper graph displayed on the Patient Treatment Monitoring screen.

The BV (Blood Volume) change graph is displayed as a fill graph. A line is filled from 0 to the BV value. As the dialysis treatment progresses, fluid is taken out of the blood by the hemodialysis machine’s ultrafiltration pump. This will result in a greater percentage of the blood being red blood cells and the blood volume fill graph will trend downwards and approach the BV alert level if set. When set; the BV alert level is drawn as a dotted line across the BV graph. To set the BV Alert Level, refer to the section **Setting the BV Alert Level** (Page 52)

The Sat (Oxygen Saturation) graph

The O₂ Sat (Oxygen Saturation) graph is a line graph drawn from the previous oxygen saturation value. When set; the O₂ Alert Level is drawn as a dotted line across the Oxygen Saturation graph. To set the O₂ Alert Level, refer to the section **Setting the O₂ Alert Level** (Page 53)



Note: Hemoglobin oxygen saturation (O₂ Sat) values have a wide range depending on the type of vascular access and other factors. An O₂ Sat value from a Central Venous Catheter will typically be lower than a value from an arteriovenous fistula or graft.

The Hct (Hematocrit) graph







The Hct (Hematocrit) graph is a line graph drawn from the previous hematocrit value. As the dialysis treatment progresses, fluid is taken out of the blood by the hemodialysis machine’s ultrafiltration pump. This will result in a greater percentage of the blood being red blood cells and the hematocrit line graph will trend upwards and approach the alert level if set.

When set the Hematocrit Alert Level is drawn as a dotted line across the Hct graph. The Hematocrit Alert Level cannot be set directly, but is calculated from the BV Alert Level (see the BV Alert Level button in the

Patient Treatment Monitoring screen section for more information). When the alert is triggered, the message “BV Alert Level” is displayed. To set the BV Alert Level, refer to the section **Setting the BV Alert Level** (Page 52).

Menu Buttons

Listed below are the features available from the menu buttons.

Feature	Description
	Menu button – Activates the Patient Run Option menu.
	Running / Paused button – Pauses or resumes the patient treatment monitoring. When monitoring is paused the button background color flashes from red to blue.
	Markers button – Allows the user to enter intervention or symptom event markers on the BV, Hct and O ₂ graphs.
	BV Alert Level button – Sets the BV (Blood Volume) Alert Level. When the cumulative Δ BV% change drops below the set BV alert level, the Crit-Line IV monitor displays the alert message “BV Alert Level”. This message will occur until the Δ BV% cumulative change increases above the set BV alert level, the user changes the level, or sets the BV Alert Level to OFF.
	O₂ Alert Level button – Sets the oxygen saturation alert level. When the current O ₂ Sat value drops below the O ₂ Alert Level, the alert message “O ₂ Alert Level” is displayed in the Status Box. The message will occur until the O ₂ level rises above the O ₂ Alert Level, the user changes the level, or sets the O ₂ Alert Level to OFF.
	End Run button – Terminates patient treatment monitoring and returns to the Patient Run menu.

Setting an Event Marker

Selecting the **Markers** button displays a menu to insert an event marker on the Δ BV%, Hct and O₂ Sat graphs.

1 Press the Markers button

Once the **Markers** button is pressed, the event marker selection screen will appear.



2 Select event marker type

Press the **Symptom** button to display a yellow diamond \blacklozenge on the graphs.

Press the **Intervention** button to display a black triangle \blacktriangle on the graphs.

Press the **Cancel** button to return without selecting an event marker.



Note: To prevent clutter on the graphs, the time between entering markers must be at least ten (10) minutes apart. If events occur more frequently than 10 minutes, the operator must document them manually in the patient treatment record

Note: Adding event markers encodes the markers in the patient treatment history file. These markers appear on each profile screen in the printed graphs.

Note: If the clinical event being marked is a patient symptom, the operator selects the Symptom button. A yellow diamond \blacklozenge on the graphic display indicates an event related to a symptom.

Note: If the clinical event being marked is an intervention to prevent a potential symptomatic response from the patient, the operator selects the Intervention button. A black triangle \blacktriangle on the graphic display indicates an event related to an intervention.

3 Confirm selection

Once the **Marker** has been selected, the event marker confirmation screen will appear.



Press the **Confirm** button to display the selected marker on the graphs.
Press the **Cancel** button to return without selecting an event marker.

Setting the Blood Level (BV) Alert Level

Selecting the **BV Alert Level** button displays a menu to set the BV Alert Level.

1 Press the BV Alert Level button

Once the **BV Alert Level** button is pressed, the BV alert level selection screen will appear to the left of the BV Alert Level button.



2 Select BV Alert Level

Set the BV Alert Level by pressing the yellow up \blacktriangle or down \blacktriangledown button until the desired level is displayed in the BV Alert Level box to the right of the select screen. The dotted line on the Δ BV% graph moves to the set BV Alert Level. The default value is -15%.



Note: As fluids are removed from the patient, the patients' blood volume decreases resulting in a negative (-) Δ BV%.

Note: Pressing the \blacktriangle button reduces the absolute Δ BV% Alert Level. For example pressing the \blacktriangle button will change the Δ BV% from (-14%) to (-13%). While this may appear counter-intuitive, the change is positive.

Note: Pressing the \blacktriangledown button increases the absolute Δ BV% Alert Level. For example pressing the \blacktriangledown button will change the

$\Delta BV\%$ from (-13%) to (-14%). While this may appear counter-intuitive, the change is negative.

3 Return

Press the **Confirm** button to confirm the entry. Press the **Cancel** button to return to the original setting. Press the **Disable** button to set the BV alert level to OFF.

Setting the O₂ Alert Level

Selecting the **O₂ Alert Level** button displays a menu to set the O₂ (Oxygen Saturation) alert level.

1 Press the O₂ Level button

Once the **O₂ Alert Level** button is pressed, the O₂ Alert Level selection screen will appear to the left of the O₂ Alert Level button.



2 Select O₂ Alert Level

Set the O₂ Alert Level by pressing the yellow up \blacktriangle or down \blacktriangledown button until the desired level is displayed in the O₂ Alert Level box to the right of the selection screen. The dotted line on the O₂ graph moves to the set O₂ Alert Level. The default value is 89%.



Note: Pressing the \blacktriangle button increases the O₂ Alert Level. Pressing the \blacktriangledown button decreases the O₂ Alert Level.

3 Return

Press the **Confirm** button to confirm the entry. Press the **Cancel** button to return to the original setting. Press the **Disable** button to set the O₂ alert level to OFF.

Ending a Patient Treatment Monitoring Session

1 Press the End Run button



Once the **End Run** button is pressed, the End Patient Run option menu will appear.



2 Make selection

Press the **Print report** button to terminate and print the Crit-Line IV patient treatment monitoring session.

Press the **Do not print report** button to terminate the Crit-Line IV patient treatment monitoring session without printing.

Press the **Cancel** button to return to the Crit-Line IV patient treatment monitoring session.



Note: When a Crit-Line IV patient treatment monitoring session is ended, either by printing or not printing, the system returns to the **Patient Run** menu.

Note: If electing not to print, patient treatment monitoring sessions are only stored for thirty (30) calendar days after which the data is automatically deleted.

3 Remove the CLiC device from the Crit-Line Blood Chamber

When the treatment is complete, pinch the CLiC device to spread the sensor elements apart and gently remove the device from the Crit-Line Blood Chamber. Store the CLiC device by clipping it to its verification filter, which is attached to its USB cable. Discard the disposable Crit-Line Blood Chamber with the rest of the bloodlines following appropriate hazardous waste handling requirements.

Patient Run Option Menu Screen

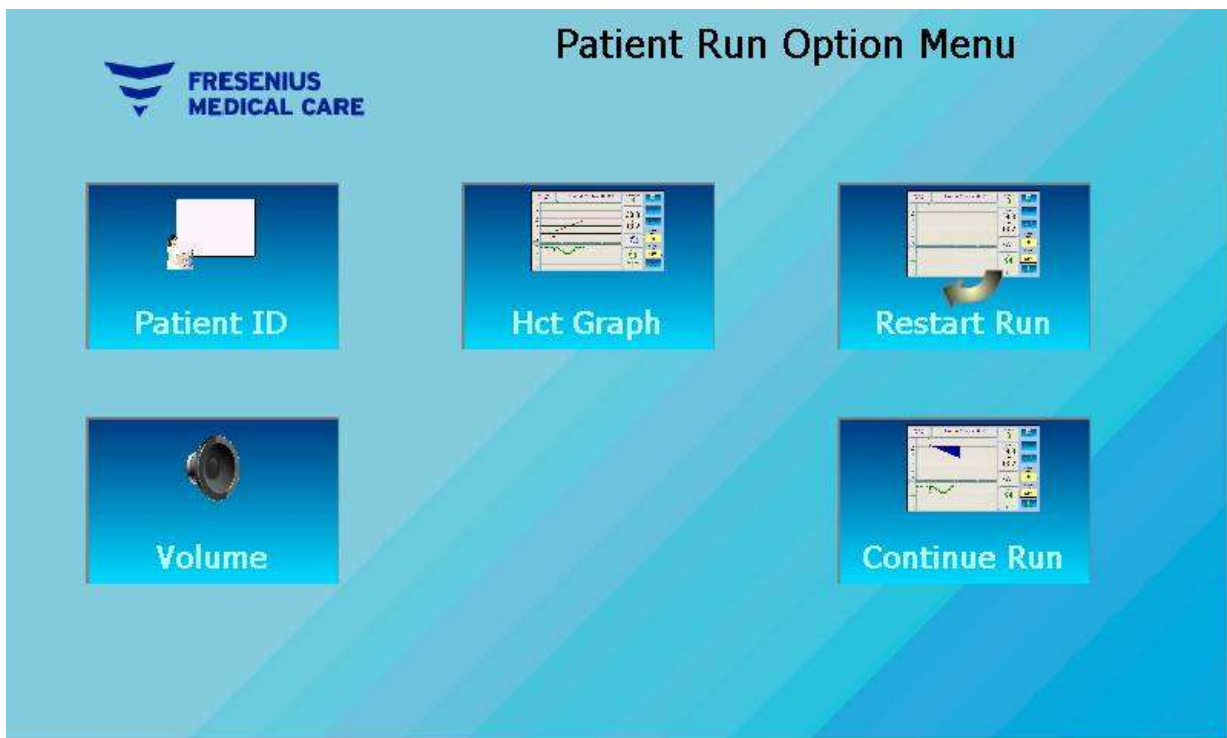





The Patient Run Option Menu screen of the Crit-Line IV monitor

Patient Run Option Menu screen

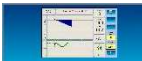
The Patient Run Option menu is used for modifying or entering patient ID information during a treatment as well as restarting a patient treatment monitoring session and selecting displayed graphs. This menu is shown on the facing page.

Listed below are the features available on this menu.

Feature	Description
 <p>Patient ID</p>	<p>Patient ID button – Allows for manually entering a Patient ID. See the Manually entering a Patient ID section for instructions.</p>
 <p>BV Graph</p>  <p>Hct Graph</p>	<p>BV / Hct Graph button – Alternates between the BV and Hct graphs being displayed on the upper graph of the Patient Treatment Monitoring Screen.</p>
 <p>Restart Run</p>	<p>Restart Run button – Restart the Patient Treatment Monitoring session. This will establish new starting Hct, O₂ Sat, Hb and ΔBV% values. The elapsed time will reset to zero and all graphs will be cleared.</p>
 <p>Volume</p>	<p>Volume button – Allows for changing the volume level of the audio alerts. See the Changing the volume level section for instructions.</p>
 <p>Continue Run</p>	<p>Continue Run button – Returns to the Patient Treatment Monitoring Screen.</p>

History Menu Screen

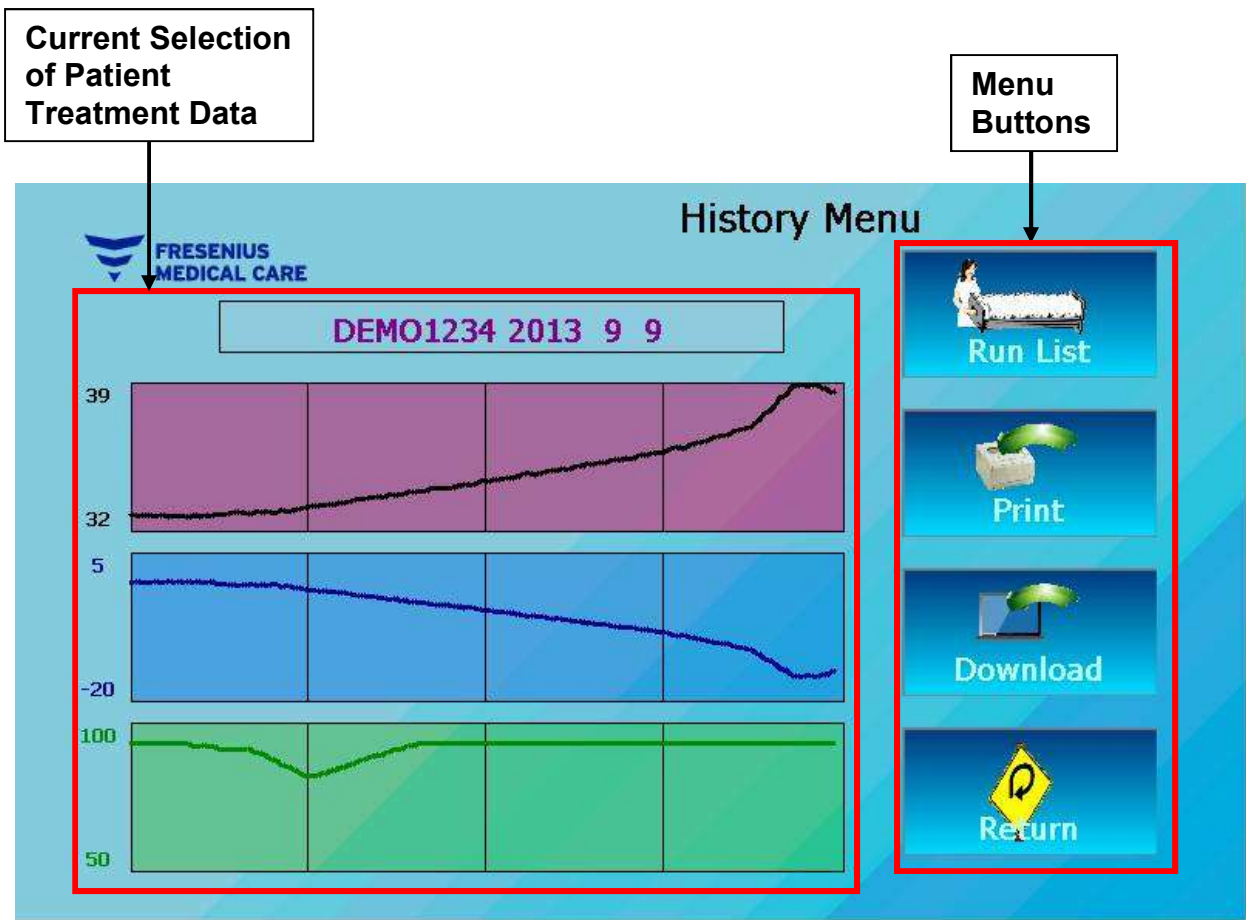

The History Menu screen of the Crit-Line IV monitor

History Menu screen

The History menu is used for reviewing, printing and downloading patient treatment monitoring data from previous treatment sessions. This menu is shown on the facing page. The **History** menu is accessed by selecting the **History** button on the **Main** menu







Note: Patient treatment monitoring sessions are stored in the Crit Line IV monitor for thirty (30) calendar days.

Note: Session data will be deleted automatically 30 calendar days after the date it was stored.

Note: The last patient treatment monitoring session is the default selection.

Listed below are the features available on this menu.

Feature	Description
	Run List button – Allows for the selection of a previous patient treatment monitoring session from a list. The list of treatments includes a patient ID number along with the date of its corresponding treatment. The order of the treatments in the list is based on the date of the treatment with the most recent treatment at the top of the list.
	Print button – Prints the selected patient treatment data.
	Download button – Downloads the selected patient treatment data. This option is typically used for research purposes and not in typical clinical environments.
	Return button – Returns to the Main Menu.

Selecting a treatment from the list

Selecting the **Run List** button allows the user to view previous patient treatment monitoring sessions from the past thirty (30) calendar days. Follow these basic steps to select a previous patient treatment monitoring session from the list.

1 Press the Run List button

Once the **Run List** button is pressed, the Select Patient Run screen will appear.

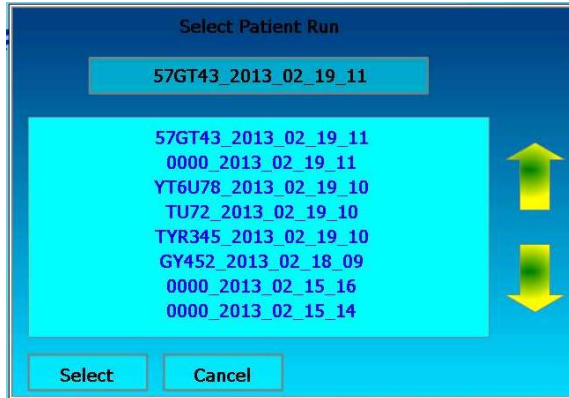

2 Select a treatment session from list

Use the up and down arrows to navigate the list of previous patient treatment monitoring sessions. Press the treatment session on the displayed list to select it. The current selection will be displayed in the upper window.

3 Return

Once the treatment has been chosen, press the **Select** button to confirm the entry. Press the **Cancel** button to return to the History menu without selecting a previous treatment.

DEMO Mode

The Crit-Line IV has a group of built-in patient treatment monitoring sessions. These sessions are provided to demonstrate some of the capabilities of the device as well as to provide training data. The built-in patient treatment monitoring sessions are accessible by selecting the **Demo** button on the **Patient Run Menu** screen.



Note: When in DEMO mode, the image on the display is updated at a rate of one minute per second. It takes approximately four minutes to complete the session.

Note: When in DEMO mode, the menu buttons remain active.

Built-in session selection

The Crit-Line IV currently has seven built-in patient treatment monitoring sessions. The default session will be selected unless one of the other sessions is selected. A built-in treatment session can be selected by:

1. Entering a patient id of 1 thru 6
2. Selecting the Demo button from the Patient Run menu.



Note: The Patient ID for a built-in session is “DEMO RUN” followed by the session index. For example if session 4 is selected then the Patient ID will be “DEMO RUN 4”. If the default session is selected the Patient ID will be “DEMO RUN”.

Built-in session profiles

The following graphs show the built-in session data:



Default Session

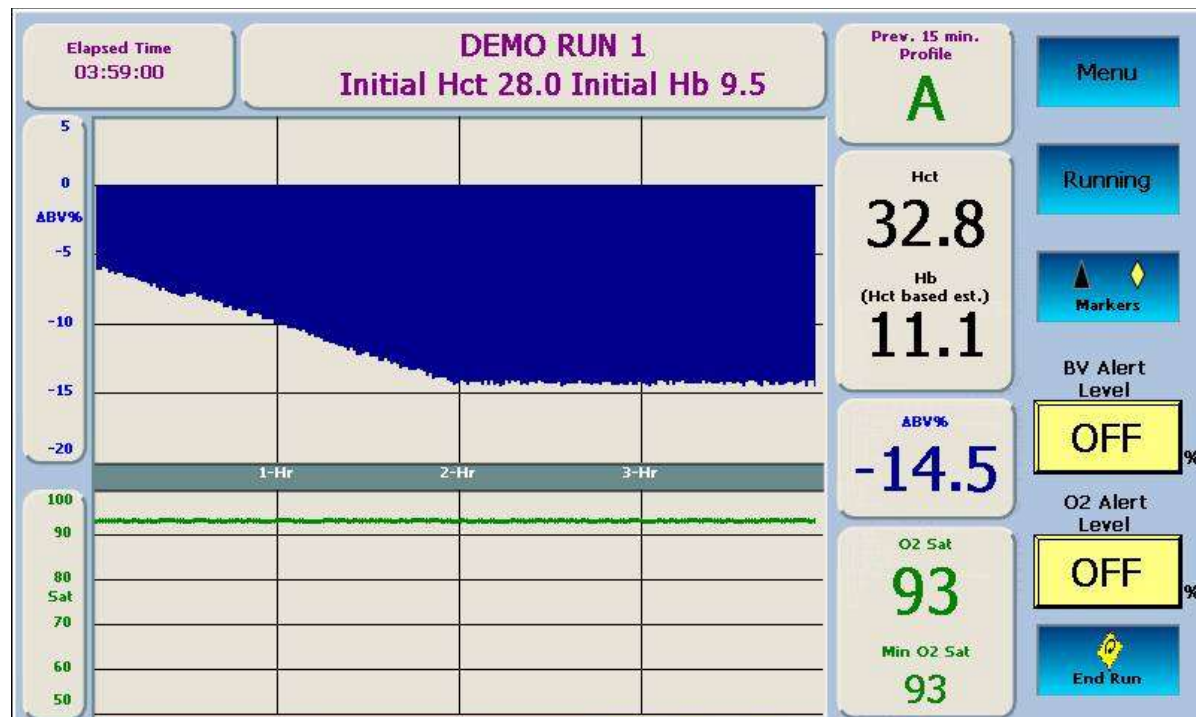

Session #1



Session #2



Session #3



Session #4

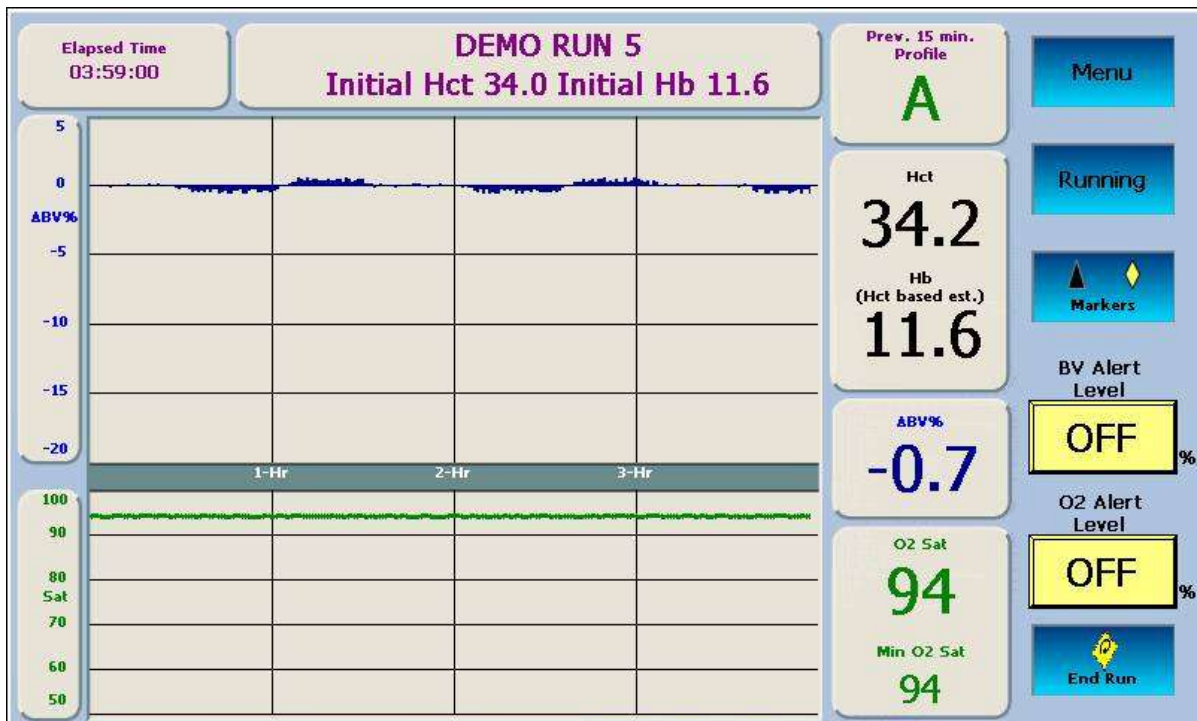

Session #5



Session #6

Replacing the CLiC device

How to replace the CLiC

The CLiC device may be changed on the Crit-Line IV monitor. This will be required if the CLiC continues to fail a verification of accuracy.



Note: The CLiC may be replaced with the Crit-Line IV monitor turned on. However, it is recommended that the CLiC be replaced with the Crit-Line IV monitor turned off.

Follow these basic steps to replace the CLiC device.

1 Remove old CLiC from Crit-Line IV monitor

Follow these basic steps to remove the old CLiC from the Crit-Line IV monitor.

1. Remove the CLiC from the Crit-Line IV monitor by gently pulling the USB connector on the CLiC out of the USB socket on the bottom of the monitor as shown.

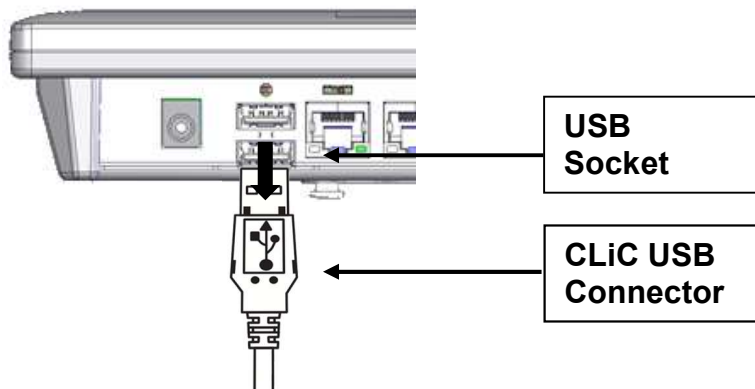

2. Remove the verification filter from the IV pole by grasping the verification filter and gently pulling it away from the IV pole as shown.

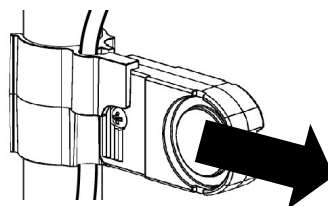

3. If the CLiC is being replaced due to repeated verification of accuracy failures; disinfect the CLiC device and dispose of it according to U.S. federal regulations 29CFR1910.145, 1910.1030 and appropriate state or local laws.

2 Insert new CLiC into Crit-Line IV monitor

Follow these basic steps to insert the new CLiC into the Crit-Line IV monitor.

1. Insert the CLiC into the Crit-Line IV monitor by gently pushing the USB connector on the CLiC into one of the USB sockets on the bottom of the monitor as shown.

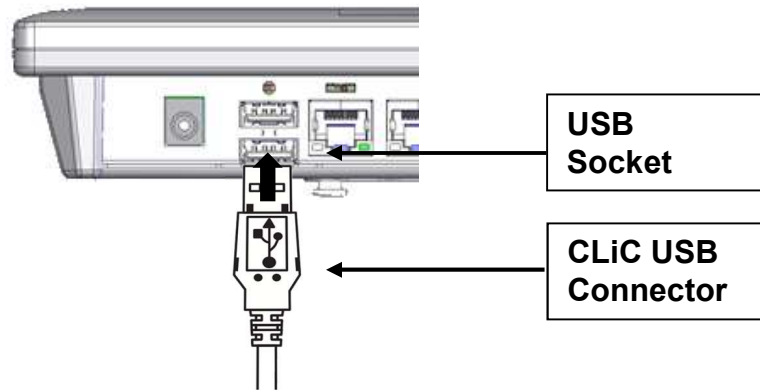

2. Attach the verification filter to the IV pole by grasping the verification filter near the base of the verification filter clip, and gently pushing it onto the IV pole. The filter will snap into place around the IV pole as shown.

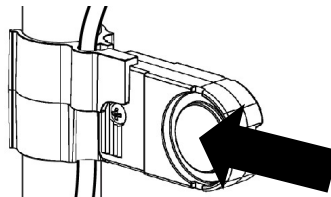

3 Place CLiC on Verification Filter

1. Hold the CLiC device such that one side is held by the index finger and other side held by the thumb. Squeeze the clip to spread the sensor elements apart.
2. Place the CLiC device over the verification filter such that the sensor elements cover the middle portion of the verification filter.
3. Release the clip to allow the sensor elements to seat on the verification filter.

4. Make certain that the CLiC device has locked securely into place on the verification filter by noting the audible and tactile click.

4 Enter verification filter ID

1. If the Crit-Line IV monitor is off, turn it on.
2. One of the following two screens will appear. The Crit-Line Clip change detected screen shown on the left will appear if the Crit-Line IV monitor detects a new CLiC. The Change Clip screen shown on the right will appear as part of the verification of accuracy failure process.

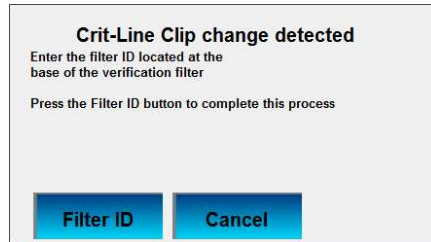

Note: The Crit-Line Clip change detected screen will appear when the CLiC is changed outside of the verification of accuracy failure process.

5 Press the Filter ID button

Once the **Filter ID** button is pressed, the Enter Filter ID screen will appear.



1. Enter the verification filter ID using the onscreen keypad. As characters are entered they will display in the top window. The filter ID is located in the middle of the verification filter, as shown.

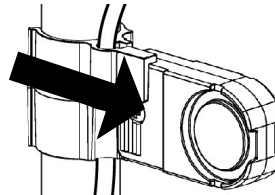

2. Once the verification filter ID has been entered, press the **Save** button.

6 Press the Ok button

Once the **Ok** button is pressed, a verification of accuracy will be performed as described in the **Verifying accuracy on the CLiC** section.



Note: Ensure that the CLiC is properly seated on the verification filter before pressing the **Ok** button.

Crit-Line IV Monitor Care

Cleaning and Disinfecting the Crit-Line IV monitor

The Crit-Line IV monitor is a sensitive electro-optical device. Use care when cleaning the exterior of the Crit-Line IV monitor, the CLiC device and verification filter so as not to damage them. The exterior of the CLiC device, verification filter, and the Crit-Line IV monitor should be cleaned after every treatment. These can all be cleaned with very dilute bleach or other suitable hospital disinfectant.

Freshly prepared dilute bleach solution (1:100) is currently recommended by the Center for Disease Control as a suitable disinfectant for the Hepatitis virus. Because surface contamination is the general mode of transmission for this type of virus, thorough cleaning of the exterior is essential.



Caution: Wipe the Crit-Line IV monitor or CLiC device with a cloth dampened with the cleaning solution; do not spray the solution on the Crit-Line IV monitor or CLiC device. Do not immerse the CLiC device in any type of liquid. If liquids infiltrate the device, they will damage it.

Caution: Do not use abrasive materials or solvents to clean the Crit-Line IV monitor or CLiC device. Doing so may cause damage.

Caution: Be careful not to scratch or damage the verification filter. If the verification filter is scratched or damaged, it may cause the CLiC device to fail verification of accuracy.

If the Crit-Line IV monitor or CLiC device becomes contaminated with blood, they must be thoroughly disinfected before the next treatment. Freshly prepared dilute bleach solution (1:100) or surface disinfectants such as Cavicide or Envirocide can be used to disinfect the CLiC device.

CLiC Device Disposal

If the CLiC device continues to fail verification of accuracy, even after recalibration, the device is no longer suitable for clinical use. Disinfect the CLiC device before disposing of it according to U.S. federal regulations 29CFR1910.145, 1910.1030 and appropriate state or local laws.

Troubleshooting, Alerts & Messages

The following troubleshooting section is a guide to help you troubleshoot Crit-Line IV monitor messages and alerts.

Messages shown on the Crit-Line IV monitor are listed alphabetically. These messages are triggered by conditions and events related to the use of the Crit-Line IV monitor that occur during operation. The messages will reset when the condition causing them is corrected. In some cases, you must reset them yourself.



Warning: Performing the recommended action may or may not clear the message or alert.











Note: Audio alerts may be muted by pressing any location on the screen.

Note: If you have any questions, please call Crit-Line Technical Service at **(800) 546-5463**.

Message	Purpose of Message	Type	Action Required
- Δ BV% greater than 8%/hr	The current blood volume percentage rate of change is greater than -8% per hour. This is activated independent of the BV Alert setting.	Alert	This message will occur until the Δ BV% change decreases below -8% per hour.
BV Alert Level	The current blood volume percentage or hematocrit has dropped below the BV Alert Level set.	Alert	Assess the patient for any changes in physiologic state. This message will occur until the Δ BV% change increases above the set BV alert level, the user changes the level or sets the BV Alert Level to OFF.
Change Clip	The screen will appear as part of the verification of accuracy failure process.	Message	Refer to the Replacing the CLiC Device (Page 65) section for detailed instructions.
Check sensor clip (CLiC) placement. To monitor blood, ensure sensor clip is on the patient's blood chamber and press 'Start Run'.	To inform the operator that a patient treatment monitoring session is about to start with the CLiC device attached to the verification filter instead of the blood chamber.	Message	Place the sensor clip (CLiC) device on the Blood Chamber and press the Start Run button.
CLiC malfunction detected Replace CLiC	The CLiC device has reported an internal failure to the Crit-Line IV and is not operational.	Alert	Replace the CLiC device. Refer to the Replacing the CLiC Device (Page 65) section for detailed instructions
CLiC not communicating. Check the CLiC USB connection	The Crit-Line IV monitor has not received data from the CLiC device.	Alert	Check the CLiC device's USB cable: <ul style="list-style-type: none"> • Make sure the cable is securely connected to one of the Crit-Line IV monitor's USB ports. • Wait up to one minute for the message to clear. If the message is not cleared: <ul style="list-style-type: none"> • Turn the Crit-Line IV monitor OFF and back ON. • When prompted, resume patient monitoring. Replace the CLiC device if the system is unable to resume communications with the CLiC. Refer to the Replacing the CLiC Device (Page 65) section for detailed instructions.
Crit-Line Clip change detected	The screen will appear when the Crit-Line IV detects a different CLiC device.	Alert	Refer to the Replacing the CLiC Device (Page 65) section for detailed instructions.

Message	Purpose of Message	Type	Action Required
Downloading print data	Informs the operator that data is being transmitted to the Crit-Line Printer Software	Message	No action required. The message will be cleared once the data transfer has been completed.
Fatal Application Error	This screen will appear if an operating system level error occurs within the Crit-Line IV.	Message	Turn the Crit-Line IV monitor OFF and ON. If the message is not cleared when the Crit-Line IV monitor is powered back on, call Crit-Line Technical Service at (800) 546-5463.
Hct Change Detected abnormal change in Hct. Press 'Restart' to start over or press 'Continue' to continue.	The Hct changed by more than 5 in the first 10 minutes. This is an indication that there has been a transition from saline to blood.	Alert	Evaluate the starting Hct value for the patient. If the patient treatment monitoring session was started with the saline prime still in the line, it may be necessary to restart the patient treatment monitoring session.
No Blood	The CLiC device no longer senses blood in the Blood Chamber.	Alert	Check the Crit-Line Blood Chamber: <ul style="list-style-type: none"> • Make sure there is proper blood flow: There should be no air or bubbles in the chamber. • Make sure the CLiC device is properly seated on the Crit-Line Blood Chamber: The device should be placed perpendicularly over the chamber and cannot be rotated up or down.
No wireless USB device. Ensure wireless USB device is connected then turn monitor OFF and back ON.	To inform the operator that the ZigBee radio is not connected to a USB port on the bottom of the Crit-Line IV or is not communicating with the ZigBee radio when an attempt was made to print using the ZigBee radio.	Message	Verify that the ZigBee radio is securely connected to one of the Crit-Line IV monitor's USB ports. Turn the Crit-Line IV monitor OFF and back ON.  Note: If this screen was encountered after ending a patient treatment, the patient treatment may be printed when the Crit-Line IV monitor is powered back on by printing from the History Menu. Refer to the History Menu Screen (Page 57) section for detailed instructions.
O2 Alert Level	The current Oxygen Saturation has dropped below the O ₂ Alert Level set on the Patient Treatment Monitoring screen.	Alert	Assess the patient for any changes in physiologic state. The message will occur until the O ₂ level rises above the O ₂ Alert Level; the user changes the level, or sets the O ₂ Alert Level to OFF.

Message	Purpose of Message	Type	Action Required
Patient monitoring was interrupted unexpectedly. Continue patient monitoring?	To inform the operator that an active patient treatment monitoring session was unexpectedly terminated. This is typically due to a power cycle during a treatment monitoring session.	Message	Press the Yes button to continue monitoring the patient treatment session. Press the No button to close the monitoring session.
			 Note: The option to resume monitoring a patient treatment session will only be given if power is restored with the CLiC device attached to the disposable blood chamber and the CLiC device detects blood in the system.
Print error	The patient treatment data was not printed. This message is displayed if the printer countdown timer (see "Waiting to Print" below) reaches zero, indicating that permission to print from the Crit-Line Printer Software was not received by the Crit-Line IV in the allowable time.	Message	Press the Ok button to clear the warning.
			 Note: Check the printer connections and try printing the patient treatment data again from the History Menu screen. For detailed instruction on printing, see the History Menu screen (Page 57) section.
			 Note: Check the printer port settings and verify that the correct port is selected. For detailed instruction on printer port selection, see Selecting the Printer Port (Page 17)
			 Note: Check the host computer and verify that the host printer software application is running.
Sensor Obstruction	Something is blocking the CLiC device's optical sensor.	Alert	Check the Crit-Line Blood Chamber: <ul style="list-style-type: none"> Remove the CLiC device from the blood chamber and check for obstructions. Reattach the CLiC device to the blood chamber. Wait up to one minute for the message to clear. If the message is not cleared: <ul style="list-style-type: none"> Cancel the patient treatment monitoring session. From the Main Menu screen, perform a manual verification of accuracy by pressing the Verify button.
			 Note: For detailed instruction on manually performing a verification of accuracy, see the CLiC Device Verification (Page 27) section.

Message	Purpose of Message	Type	Action Required
Verification Filter Detected Select "End Run" to end session	The Crit-Line IV detected a transition from blood to the verification filter during a patient treatment monitoring session.	Message	<p>If the change was intentional because the treatment monitoring session has ended, end the monitoring session. Otherwise, place the CLiC device back on the blood chamber</p> <p> Note: This message will only occur in Standard Run Mode. For more details regarding Auto vs Standard Run Mode, see the Auto vs Standard Run Mode (Page 23) section.</p>
Verify – Attach sensor clip (CLiC) to verification filter	The CLiC device has not been verified within the past 30 calendar days or has failed verification.	Message	<p>Verify the CLiC device:</p> <ul style="list-style-type: none"> Place the CLiC device on the CLiC Verification Filter, which is attached to its USB cable. Press the Ok button to clear the message. <p>Perform a manual verification of accuracy by pressing the Verify button</p> <p> Note: For detailed instruction on manually performing a verification of accuracy, see the CLiC Device Verification (Page 27) section.</p>
Verify Failed	The verification of accuracy test shows that the CLiC device is not ready for use during treatment.	Message	<p>Re-Verify the CLiC device:</p> <ul style="list-style-type: none"> Ensure the CLiC device is on the CLiC Verification Filter, which is attached to its USB cable. Press the Verify button to perform another verification of accuracy. Press the Cancel button to clear the message. <p> Note: For detailed instruction on manually performing a verification of accuracy, see the CLiC Device Verification (Page 27) section.</p>
Waiting to print	To inform the operator that the Crit-Line IV is waiting for permission to print from the Crit-Line Printer Software on the computer used for printing.	Message	<p>No action required. The printer countdown timer displayed next to the message informs the operator that printing is pending.</p> <p>Printing may be canceled at any time by pressing the Cancel button</p> <p> Note: If the printing is canceled the treatment session may be printed at a later time by printing the treatment from the History Menu. For detailed instruction on printing, see the History Menu screen (Page 57) section</p>

Appendix

Product Improvement Policy

The CLiC device was designed and built to comply with the product specifications noted below. It is the intention of Fresenius Medical Care to improve products continuously, a process which may result in modifications to specifications or equipment produced in the future. Such product improvements shall not incur any obligation to make similar changes or improvements to equipment previously produced. These changes or improvements may or may not be applicable or usable with previously produced equipment. Where possible, improvements will be made available at reasonable prices. Any such improvement shall not be construed as corrections of any perceived deficiency.

Warranty

Sale of the parts described or referenced herein is expressly conditioned upon the terms and conditions set forth below. Any additional or different terms or conditions set forth by the Purchaser to Fresenius Medical Care, (herein called "the Company") shall not be effective or binding, and the terms set forth herein shall not be modified or amended, unless assented to in writing by an authorized official of the Company located in Waltham, Massachusetts.

LIMITED WARRANTY: The Company warrants to the Purchaser that the equipment delivered is free from defects in material or workmanship, provided the equipment is used and maintained in accordance with the original manufacturer's operating instructions:

The Company will replace any parts subject to this warranty, which are proven defective in materials or workmanship. Such replacement will be made without cost to the Purchaser. The Warranty does not apply to any equipment which is misused, abused, neglected, tampered with, damaged by accident, flood, fire, or other hazard, subjected to abnormal or unusual electrical or fluid stress, improperly installed or operated, or not maintained in accordance with the care instructions set forth in the operating manual for the equipment.

Routine maintenance is not covered under warranty. Modifications, alterations, installation and service by any other than a Fresenius Medical Care authorized representative may void the warranty.

WARRANTIES APPLICABLE TO EQUIPMENT EXTEND ONLY TO THE PURCHASER, AND ARE NOT ASSIGNABLE OR TRANSFERABLE, AND SHALL NOT APPLY TO AUXILIARY EQUIPMENT, OR DISPOSABLE ACCESSORIES. THE

FOREGOING WARRANTY SHALL BE IN LIEU OF ANY OTHER WARRANTIES, EXPRESSED IMPLIED OR STATUTORY, RESPECTING THE EQUIPMENT OR ANY PARTS OR COMPONENTS THEREOF, AND THE COMPANY MAKES NO IMPLIED WARRANTY OF MERCHANTABILITY OR FITNESS FOR A PARTICULAR PURPOSE. THE PURCHASER'S SOLE AND EXCLUSIVE REMEDY IN CONTRACT, TORT, OR UNDER ANY OTHER THEORY AGAINST THE COMPANY RESPECTING THE EQUIPMENT AND ITS USE SHALL BE THE REPLACEMENT OF THE EQUIPMENT AND ITS PARTS AS DESCRIBED ABOVE, AND NO OTHER REMEDY (INCLUDING, WITHOUT LIMITATION, CONSEQUENTIAL DAMAGES) SHALL BE AVAILABLE TO THE PURCHASER. The Company shall have no further obligation or liability with respect to the equipment or its sale, operation and use, and the Company neither assumes, nor authorizes the assumption of, any obligation or liability in connection with such equipment.

Crit-Line IV Monitor and Spare Parts

Crit Line IV Monitor	P/N CL10051001
CLiC Device	P/N CL10041001
Pole Mount	P/N CL10054004
Crit Line IV User's Guide	P/N CL80050002
ZigBee Radio	P/N CL90000076
Crit Line Printer Software	P/N CL10029504
Power Supply Adapter	P/N CL44300012
Power Cord	P/N CL90000035



Note: Call Fresenius Medical Care Customer Service Spare Parts at (800) 546-5463.

Additional Information

For more information, please contact:



 **Fresenius Medical Care North America**
Waltham, MA 02451
1-800-323-5188
Assembled in Mexico

perr

Crit-Line IV Monitor Specifications

Dimensions	Crit-Line IV Monitor: 5.50”H, 9.00”W, 1.60”L (14.0cm H, 22.9cm W, 4.1cm L) Pole Mount:: 3.5”H, 5.75”W, 4.00”L (8.9cm H, 14.6cm W, 10.2cm L)
Weight	Crit-Line IV Monitor: 0.80 lbs. (363 gm) Pole Mount: 1.25 lbs. (567 gm)
Operating Conditions	50 °F to 104 °F (10 °C to 40 °C)
Storage & Transportation Conditions	-4 °F to 125 °F (-20 °C to 51 °C)
Altitude	0 – 9843’ (0 – 3000 m)
Internal Data Storage	Stores previous 30 calendar days of patient treatment data.
Power to Monitor	12 VDC / 1A / 12W
Power Supply	100 – 240V / 50 – 60 Hz / 0.3A Min.
Communication Ports (used)	DB9 Serial (COM1) / 9600 Baud 8N1 USB ZigBee Radio
Water Ingress Protection	IP-64 front panel. Do not immerse in liquid.
Anesthetic Suitability	Not suitable
Modes of Operation	Continuous
CLiC Sensor	See CLiC IFU, Document # CL80040002

EMC Compliance

Medical electrical equipment needs special precautions regarding electromagnetic compatibility (EMC) and needs to be installed and put into service according to the EMC information provided herein.

The Crit-Line IV monitor is intended for use in the electromagnetic environment specified below. The user of the Crit-Line IV monitor should assure that it is used in such an environment.		
Emissions test	Compliance	Electromagnetic environment – guidance
EN 55011:2007 per EN 60601-1-2:2007	Group 1	<p>The Crit-Line IV monitor uses radio frequency (RF) energy only for its internal function. Therefore, its RF emissions are very low and are not likely to cause any interference in nearby electronic equipment.</p> <p>The Crit-Line IV monitor is suitable for commercial, industrial, or business use. This classification covers devices for usage in all establishments other than domestic and that are not directly connected to a low voltage power supply network, which supplies domestic environment.</p> <p>Warning: This Class A equipment is intended for use in industrial areas and hospitals. There may be potential difficulties in ensuring electromagnetic compatibility in other environments, such as the domestic environment, due to conducted as well as radiated disturbances."</p>
EN 55011:2007 per EN 60601-1-2:2007	Class A	
Harmonic Emissions IEC 60601-1-2:2007, EN 61000-3-2	Class A	
Voltage Fluctuations / Flicker Emissions IEC 60601-1-2:2007, EN 61000-3-3	Complies	

ZigBee Radio

When installed, the following table provides details regarding the ZigBee Radio.

Manufacturer	Telegesis (www.telegesis.com)
Model	ETRX3USB-LRS
FCC ID	S4GEM35X2
FCC Compliance	Class B Digital Device
Frequency Band	2.4GHz ISM Band
Type of Modulation	Digital direct sequence spread spectrum stranceiver
Effective Radiated Power	+20dBm typical output power
Transmission Standard	IEEE802.15.4
Radio	 <p>This product contains a radio transmitter. If any interference is suspected, move the product farther away from the equipment being interfered with. Interference with other equipment is unlikely as the ZigBee Radio is very low power.</p>

Glossary

- Blood Volume** – The amount of blood circulating in a cardiovascular system.
- CLiC** – The Crit-Line Clip (CLiC) is a device used to non-invasively measure hematocrit, oxygen saturation and percent change in blood volume.
- CLiC Status** – The operational status of the CLiC device.
- Crit-Line Blood Chamber** – A single use, sterile chamber that attaches to a blood line. The Crit-Line blood chamber provides a docking point for a CLiC device.
- Event** – A symptom or intervention that takes place during a patient treatment monitoring session. Events can be marked using event markers.
- Hb** – Abbreviation for hemoglobin. The hemoglobin value displayed by the Crit-Line IV monitor is an estimate based on hematocrit.
- Hct** – Abbreviation for hematocrit. This is the percent of red blood cells in blood.
- Initial Hb** – This is the Hb value recorded at the beginning of a patient treatment monitoring session.
- Initial Hct** – This is the Hct value recorded at the beginning of a patient treatment monitoring session.
- O₂ Sat** – Abbreviation for oxygen (O₂) saturation. The value is a percentage of the maximum oxygen (O₂) carrying capability of blood.
- Output Port** – This identifies a data port used to transmit serial data to a host device. The options on the Crit-Line IV monitor are Serial COM 1 (DB9) and ZigBee radio.
- Patient ID** – This is an alpha-numeric string used to link a patient to a patient treatment monitoring session.
- Patient Run** – See Patient Treatment Monitoring Session.
- Patient Treatment Monitoring Session** – This term is used to identify the block of time that the Crit-Line IV monitor is monitoring the patient treatment. During a treatment monitoring session the Crit-Line IV collects and displays Hct, Δ BV%, and O₂ Sat data.
- Printer Port** – This identifies a data port used to communicate with the host printer software. The options on the Crit-Line IV monitor are Serial (COM 1 (DB9)) and ZigBee radio.
- Profile** – This term is used to identify the rate of change for the Δ BV%. The Crit-Line IV monitor identifies three profile types: A = Rate of change of < 3% per hour, B = Rate of change between 3% and 6.5% per hour and, C = Rate of change greater than 6.5% per hour.
- Station ID** – This is a 2-digit value used to link a Crit-Line IV monitor to a specific dialysis station.
- Touch Screen** – An electronic visual display that the user can control through simple gestures by touching the screen with a finger or stylus.
- Verification Filter** – A filter unique to each CLiC device used to periodically verify the accuracy of the CLiC device.
- ZigBee Radio** – A radio based on the ZigBee wireless communication technology.
- Δ BV%** - A percent change in the blood volume. This formula is Δ BV% = [(Initial Hct/Current Hct)-1]*100

Index

- Attach sensor clip (CLiC) to verification filter, 74
- Auto Run, 15, 22
- Blood Line, 37
- Blood Volume, 3, 4, 51, 71
- BV Alert Level, 71
- Change Clip, 71
- Check sensor clip (CLiC) placement, 71
- CLiC, 2, 3, 7, 8, 10, 11, 15, 25, 26, 27, 37, 39, 41, 53, 64, 65, 67, 68, 69, 71, 73, 75, 76
- CLiC malfunction detected, 71
- CLiC not communicating., 71
- CLiC Status, 25, 39, 41
- Crit-Line Blood Chamber, 3, 7, 8, 32, 33, 36, 37, 53, 72, 73
- Crit-Line Clip change detected, 71
- DB9, 16, 19, 77
- Event Markers, 49, 50
- Fatal Application Error, 72
- Hb, 48
- Hct, 3, 47, 48, 49, 50, 55, 72
- Hct Change, 72
- Initial Hb, 47
- Initial Hct, 47
- IV pole, 7, 10, 11, 64, 65
- No Blood, 72
- No wireless USB device, 72
- O2 Alert Level, 72
- O2 Sat, 3, 44, 45, 46, 47, 48, 49, 50, 52, 72
- Output Port, 15, 16, 19
- Patient ID, 41, 42, 43, 47, 55, 59
- Patient monitoring was interrupted unexpectedly, 73
- Patient Treatment Monitoring Session, 9, 15, 43, 47, 55, 57, 58, 59, 71, 73, 74
- Pole Mount, 7, 10
- Power Cord, 9, 10, 12, 76
- Power Supply Adapter, 9, 10, 12, 76
- Print error, 73
- Printer Port, 15, 16, 25
- Profile, 47, 60
- Sensor Obstruction, 73
- Station ID, 15, 18, 25
- Technical Services, 70, 72
- Touch Screen, 7
- USB, 11, 25, 37, 39, 41, 53, 64, 65, 71, 72, 74, 77
- Verification Filter, 2, 4, 8, 10, 11, 15, 25, 26, 27, 30, 39, 41, 53, 64, 65, 68, 69, 74
- Verification Filter Detected, 74
- Verify Accuracy, 4, 25, 26, 39
- Verify Failed, 74
- Waiting to print, 74
- ZigBee, 16, 19, 72, 76, 77, 78
- Δ BV%, 47, 48, 49, 50, 51, 71
- Δ BV% greater than 8%, 71