

User's Guide



Liberty
Select
united with stay-safe®

Liberty Select Cyclor User's Guide

© Copyright 2019 Fresenius Medical Care—All Rights Reserved

This document contains proprietary information of Fresenius USA, Inc. d/b/a Fresenius Medical Care North America and its affiliates (“Fresenius Medical Care”). The contents of this document may not be disclosed to third parties, copied, or duplicated in any form, in whole or in part, without the prior written permission of Fresenius Medical Care.

Fresenius Medical Care, the triangle logo, stay•safe, Liberty and Liberty Select are trademarks of Fresenius Medical Care Holdings, Inc., or its affiliated companies. All other trademarks are the property of their respective owners.

This document is for software version 2.9.0 (Liberty Select Cyclor).

The Liberty® Select Cyclor is manufactured by:

*Fresenius USA, Inc.
4040 Nelson Ave
Concord, CA 94520*

Caution: *Federal (US) law restricts this device to sale only by or on the order of a physician.*

Caution: *Frequency, duration, and treatment settings are to be determined by the prescribing physician.*

Indications for Use: *The Fresenius Liberty Select Cyclor is indicated for acute and chronic peritoneal dialysis.*

How to Use this User's Guide

This User's Guide is a reference for you to look up information about the Liberty Select Cyclor. Start with the topic you are interested in, and look for it in the Table of Contents (see page 4) or in the Index (see page 266). The Table of Contents is detailed enough that you should be able to find most topics. If not, refer to the Index for further details.

Please note that the Contents Quick Search (see page 3), Glossary (see page 262), and Error Messages Tables (see page 221 and 230) also contain similar information, but presented in a slightly different way. The goal of the User's Guide is to help you find the information you need quickly and easily..

The User's Guide is developed as a reference and guidance for information for all of your automated peritoneal dialysis (APD) treatments. The order of the topics presented here is the same order you will follow as you set up your treatment.

Contents Quick Search

This page is a quick reminder where to find certain procedures or further instructions:

Events

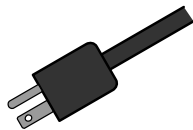

- Power Failure: 242
- Troubleshooting Error Messages: 218
- Incomplete Treatment: 17
- Alarms (with no sound): 207
- Defective cassette/tubing set: 105
- Moisture in pump module: 169
- Drain Complication: 231
- Patient Line is Blocked: 233

Liberty Select Cyclor Settings



- How to set weight (SI) units: 86
- How to change the time/date: 94
- How to set screen blanking: 94
- How to adjust the alarm/key volume: 94

Treatment Setup

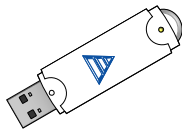

- How to use the IQdrive: 194
- How to set your parameters: 52
- Pre-Treatment checklist: 98
- How to insert stay•safe PIN connector into stay•safe organizer: 106

Exchanges



- How to bypass: 186
- How to do a STAT drain: 184
- Drain times based on Fill volume: 240

Technical Support Number: 1-800-227-2572

Table of Contents

How to Use this User's Guide	2
Contents Quick Search	3
My Treatment Settings	6
Introduction.....	12
Requirements.....	12
Purpose of the Liberty Select Cyclor.....	12
Contraindications (When this machine should not be used).....	13
Peritoneal Dialysis Precautions	13
About This User's Guide	14
Peritoneal Cyclor Preventive Maintenance:.....	16
Related Reading	16
For Technical Questions	16
For Medical or Clinical Questions	16
General Warnings	17
Meet Your Liberty Select Cyclor.....	22
The Control Panel	26
The Status Bar.....	28
Touch Screen Buttons	30
Navigating With Screen-Buttons	32
The Pump Module.....	34
The Cassette and Tubing Set.....	38
The stay•safe Organizer	42
The Heater Tray.....	44
Setting up Your Liberty Select Cyclor	46
Entering Your Prescription	50
Entering Your Treatment Settings.....	52
Select Therapy Tab	54
CCPD: Treatment-Based Settings	56
CCPD: Cycle-Based Settings.....	58
IPD: Treatment-Based Settings.....	60
IPD: Cycle-Based Settings	62
PD+: Treatment-Based Settings	64
PD+: Cycle-Based Settings	66
Tidal: Treatment-Based Settings.....	68
Tidal: Cycle-Based Settings	72
Patient Settings Tab	76
Options Settings Tab	86
Hardware Settings Tab	94
Pre-Treatment Checklist.....	98

Starting Your Treatment.....	100
Preparing.....	104
Priming.....	122
Ready for Treatment - Connecting Yourself	132
Exchanges.....	136
Exchange: Drain 0	138
Exchange: Fill1	140
Exchange: Pause.....	142
Exchange: Dwell	148
Additional Drain Option	150
Ending Your Treatment	154
Your Treatment Summary.....	162
Power Down Cyclor	170
Appendix	174
The My Records Screen-Button.....	176
Using the STOP key	182
Using the STAT Drain	184
Bypassing a Phase	186
Using the IQdrive (Optional)	194
Using the Wireless Modem (Optional)	200
Moving Your Liberty Select Cyclor.....	202
Warnings and Alarms.....	206
Warnings and Alarms (continued).....	208
Warning: The Help Button.....	212
Alarm: Red Status Bar	216
Troubleshooting	218
Error messages listed by code.....	221
Error messages listed alphabetically	230
Different People Drain Differently	240
Power Failure	242
Cleaning Your Cyclor	248
Machine Specifications.....	250
Manufacturer's EMC Declaration	254
Product Improvement Policy	258
Warranty.....	258
Glossary	262
Index.....	266

My Treatment Settings

Use this page for your treatment values as prescribed by your doctor or practitioner. Use only one of these prescriptions for your treatment.

therapy	CCPD	<input checked="" type="checkbox"/> Treatment Based
cycles/pauses	volumes	times
	total volume	total sleep time
	fill volume	
	last fill volume	

therapy	CCPD	<input checked="" type="checkbox"/> Cycle Based
cycles/pauses	volumes	times
# fills	fill volume	dwel time
		fill time
	last fill volume	drain time

therapy	IPD	<input checked="" type="checkbox"/> Treatment Based
cycles/pauses	volumes	times
	total volume	total sleep time
	fill volume	
# pauses	pause volume	

therapy	IPD	<input checked="" type="checkbox"/> Cycle Based
cycles/pauses	volumes	times
# fills	fill volume	dwel time
# pauses	pause volume	fill time
		drain time

therapy	PD+	<input checked="" type="checkbox"/> Treatment Based
cycles/pauses	volumes	times
	total volume	total sleep time
	fill volume	
# pauses	pause volume	
	last fill volume	

therapy	PD+	<input checked="" type="checkbox"/> Cycle Based
cycles/pauses	volumes	times
# fills	fill volume	dwel time
# pauses	pause volume	fill time
	last fill volume	drain time

therapy		TIDAL		<input checked="" type="checkbox"/> Treatment Based
cycles/pauses		volumes		times
		total volume		total sleep time
# pauses		pause volume		
		first fill volume		
		tidal fill volume		
		tidal drain vol.		
		last fill volume		

therapy		TIDAL		<input checked="" type="checkbox"/> Cycle Based
cycles/pauses		volumes		times
# pauses		pause volume		dwelling time
		first fill volume		fill time
# fills		tidal fill volume		drain time
		tidal drain vol.		
		last fill volume		

patient

your ID	weight

options

add diurnal UF	last bag option	drain exit %
language	SI units	personal data
USB enabled	add. drain	add. drain alert
flow alert	flow alert sound	

Notes: _____

Introduction & Overview

Introduction

Enjoy the freedom that the Liberty Select Cyclor offers you. We at Fresenius Medical Care know that life on peritoneal dialysis may be complicated, but we have worked hard to make it simpler. Your Liberty Select Cyclor is light, portable, and easy to operate. It has an easy to load cassette and simple touch screen menus to guide you through setup and treatment procedures. Carefully following your doctor or practitioner's instructions, you have the convenience and freedom of peritoneal dialysis at your fingertips. Be sure to read and follow all instructions and warnings listed in the User's Guide.

Requirements

Operators like you must be trained on the Liberty Select Cyclor to perform peritoneal dialysis under the direction of a physician. In addition, each operator should be:

- Knowledgeable of peritoneal dialysis procedures and how they affect the body
- Well-practiced in aseptic techniques and other peritoneal dialysis procedures
- Very familiar with the contents of this User's Guide as well as fully trained and qualified to operate this machine. You and any other user must be able to identify between normal and abnormal operation.

Purpose of the Liberty Select Cyclor

The Liberty Select Cyclor is indicated for short term (acute) and long term (chronic) peritoneal dialysis.

The Liberty Select Cyclor can provide the following therapies:

- Continuous Cycling Peritoneal Dialysis (CCPD)
- Intermittent Peritoneal Dialysis (IPD)
- Peritoneal Dialysis Plus (PD+)
- Tidal Peritoneal Dialysis (TPD)

Contraindications (When this machine should not be used)

CAPD and CCPD are effective and attractive choices for many ESRD patients; however, no one dialysis therapy is right for all patients. The following health problems may prevent you from using the Liberty Select Cycler:

- Leaks across the inside of your body's lining (Transdiaphragmatic leakage)
- A destructive metabolism (hypercatabolism)
- Too little peritoneal membrane surface area
- Multiple abdominal surgeries

This is a guideline only. Your doctor or practitioner must make the final decision whether the Liberty Select Cycler is appropriate for you.

MR (Magnetic Resonance) Unsafe: Liberty Select Cycler must not to be used in an MR environment. Liberty Select Cycler may pose unacceptable risks to the patient, medical staff or other persons within the MR environment.

Peritoneal Dialysis Precautions

Your doctor or practitioner has prescribed peritoneal dialysis (PD) for you. There are risks to PD, but your doctor feels it is better to perform PD than not. Here are some things you and your doctor or practitioner should consider:

You must perform PD treatments according to the prescription given to you by your physician and the manufacturer's instructions. Not doing so may result in harm. Abdominal pain, bleeding, infected peritoneal membrane (peritonitis), and a blocked catheter extension set can cause problems with your treatment. Some dialysate solutions are stronger (higher percentage of dextrose) than others at removing fluids. It is important to use the right dialysate solution for your needs: the wrong dialysate solution may pull too much fluid (hypovolemia/dehydration) out of your body and may cause low blood pressure (hypotension) or muscle cramping. Or it may pull too little fluid (hypervolemia/overhydration) and may cause high blood pressure (hypertension) or swelling (edema). You must continue to remove the right amount of fluid from your body.

You and your PD nurse must work together to monitor your body weight and blood chemistry levels. You must pay close attention to how you feel and report any changes to your PD nurse. This may help prevent such complications as congestive heart failure, volume depletion, overfill of solution, shock, and inadequate therapy. Follow your prescription and instructions to reduce the risk of these problems that could result in serious complications.

Care partners should carefully monitor patients for the above signs and symptoms.

About This User's Guide

This User's Guide is a reference for properly trained home users of the Liberty Select Cycler—it does not replace formal training by your PD nurse. It cannot provide or replace clinical advice.

This User's Guide is specially designed for easy readability and understanding. It has illustrated procedures and step-by-step instructions.

Follow your machine's on-screen instructions. Use this User's Guide as a guide for your machine's screens. You should read the entire User's Guide before beginning your treatment. Take note of attention boxes, explained below:

Attention Boxes



Warning: This symbol warns against an action or situation that could hurt you. If you do not follow these instructions, it can lead to serious injury or death.



Shock Hazard: This symbol means you could get a severe electrical shock if you use the equipment wrong.



Caution: This symbol means you will damage your machine if you do not follow instructions.



Note: This symbol means there is extra information about machine features. Notes have helpful information and tips. They may also show instructions for unique cases.

Other Important Symbols



Degree of protection against electric shock: Type BF



Symbol for Alternating Current (AC).



Symbol for a Protective ground terminal.



This symbol with the finger pinch in the background means to keep fingers clear of any moving parts.



ON: This symbol, at the top of the switch on the back of your machine, means the switch is in the ON position.



OFF: This symbol, at the bottom of the switch on the back of your machine, means the switch is in the OFF position.



This symbol stands for the USB port located on the back of the machine. This port is where you connect your IQdrive.



This symbol stands for the RS232 Serial Port Connection on the cyclers' rear panel (for modem only).



This symbol on the back of your cycler means to consult the operating instructions for proper use of the equipment.



MR (Magnetic Resonance) unsafe: This symbol, on the back of your machine, means the machine must not be placed in an MR environment.



This symbol on the back of your cycler indicates that Interference may occur in the vicinity of the machine.

Peritoneal Cyclers Preventive Maintenance:

All Fresenius Medical Care Peritoneal Cyclers are designed to detect drifting calibrations and mechanical failures through an extensive self-check built into the machine. This check is done each time the machine is powered on. Functional parameters are also continuously monitored throughout the treatment. The only required maintenance is surface cleaning as stated in the User's Guide.

If problems do occur, in most cases Fresenius Medical Care will replace the cycler within 1 working day and, if applicable, arrange to pick up the used cycler. The replacement policy applies only to those cyclers that remain the property of Fresenius Medical Care North America. History files on these devices are maintained by Fresenius Medical Care North America.

Related Reading

These documents have more information about your Liberty Select Cycler:

- Liberty Select Cycler Initiating Treatment Procedure Card
- Liberty Select Cycler Handi-Guide
- Liberty Select Cycler Field Service Bulletins may be obtained from the Fresenius Medical Care website: www.FMCNA.com or contact your healthcare professional for more information.

For Technical Questions

If you have any questions, please call a Fresenius Medical Care Technical Support Representative anytime at **1-800-227-2572**.

For Medical or Clinical Questions

Call your home therapy nurse or on-call nurse.

General Warnings

Read all the warnings before beginning your treatment. Additional warning statements for each topic are found throughout the User's Guide.



Warning: Read this entire User's Guide before beginning your treatment. You must be familiar with how to use your machine and with the features of this User's Guide. If you do not follow these instructions to install and maintain this equipment, it may cause serious injury or death.



Warning: Protective measures **MUST** be taken to prevent backup in the drain line. When connecting the drain line, ensure that an air gap is maintained between the drain line and the drain.



Warning: Your doctor or practitioner must prescribe your entire treatment. If you use incorrect values, it may cause serious injury or death. Do not use example values shown in machine pictures.



Warning: In the event of an **incomplete treatment**, call your doctor, practitioner, or PD nurse.



Warning: Check for proper functioning of your machine before beginning your treatment. Alarm failure or unidentified problems could lead to serious health risks.



Warning: Keep fingers clear of moving parts.



Warning: The Liberty Select Cycler is not sterile equipment. Only the interior of the tubing sets are sterilized. You must use aseptic technique (masking and hand washing) as directed by your PD nurse to prevent infection. Infections may cause serious injury or death.



Warning: Explosion Hazard. Do not use in the presence of flammable substances like anesthetics.



Warning: Check that all tubing is free from kinks or damage (scratches, loose tubing, small holes) before beginning treatment.



Warning: Do not use damaged cassettes for your treatment. Damaged cassettes can lead to leaks, contamination, and infection.



Warning: Do not allow any liquid to drip in or on your machine. Spills from your treatment can lead to serious injury or death. If spills occur, immediately contact a Fresenius Medical Care Technical Support Representative at **1-800-227-2572**. Do not attempt to clean or disinfect leaks inside your cyclor.



Warning: You must clean your machine to prevent contamination and infection.



Warning: Do not use devices emitting strong electromagnetic radiation such as portable phones, radio equipment (walkie-talkies, etc.), radio transmitters, and like equipment near your machine. Improper operation may result. Digital phones may be conditionally allowed. Discontinue use of any device if any interference is noted, such as false pressure readings that disappear when the external signal is removed.



Warning: You must keep your machine away from pets, pests and children to prevent contamination and infection.



Warning: Use caution when handling the cyclor tubing set as it may cause strangulation.



Warning: The power cord, tubing set and drain line(s) can be a trip hazard and may result in falls.



Warning: If the fluid in the drain line appears cloudy, contact your PD nurse because this could be an early sign of infection.



Warning: Increased Intraperitoneal Volume (IIPV), commonly known as Overfill, is when you have too much fluid in your abdomen. IIPV/overfill may result in serious injury or death from conditions such as: abdominal wall and/or diaphragmatic hernias, hydrothorax, heart problems including chest pain and heart failure, high blood pressure, pulmonary edema, decreased pulmonary function and pericardial effusion.

Patients and care partners should watch for the potential signs of IIPV. These include:

- Difficulty breathing
- Vomiting or spitting up
- Feeling full, bloated, or overfilled after treatment
- Abdominal pain or discomfort
- Expanded or tense abdomen
- Chest pain
- Increased blood pressure
- Change in mental status
- Leakage of fluid from the PD catheter extension exit site.

If you experience any of these symptoms or feel a large, painful build-up of pressure during your fill, do not finish your fill cycle. Press the **STOP** key and immediately initiate a STAT Drain or perform a manual drain as instructed by your PD nurse. See page 184 for more information on how to use the STAT Drain feature. Once the fluid is completely drained from your abdomen, call your doctor, practitioner, or PD nurse.



Warning: If you have no Last Fill programmed on your cyclor and you did a manual Fill during the day, your cyclor does not know that you must drain additional fluid from the abdomen. If your catheter extension set line then gets kinked during Drain 0 and the draining stops, your cyclor may advance to Fill 1 before you have finished draining your abdomen. This may cause an overfill situation which may lead to serious injury or death. Always make sure that you have drained enough during Drain 0 when your cyclor starts Fill 1.

Drain 0 may be bypassed under certain circumstances. Please consult your PD nurse before bypassing Drain 0. See page 186 for more information.



Warning: Shock hazard. Do not remove Heater Tray. Refer servicing to qualified personnel. The electrical source must be single phase, three-conductor type at 120/250 VAC 50/60Hz. Your cyclor needs a protective earth electrical ground connection. The outlet you use for your cyclor must be checked and maintained for a good ground connection to protect you from risk of electrical shock.



Warning: Shock hazard. The machine must be plugged directly into an electrical outlet; do not use extension cords or power strips. Do not use power cords other than those provided with your cyclor. Do not use the power cord if broken or damaged. If you must connect your cyclor to a 240V power source, contact a Fresenius Medical Care Technical Support Representative at **1-800-227-2572** for a power cord rated for 240V.



Caution: Do not place your cyclor near external heating or cooling sources like heaters or air conditioners.



Caution: Your Liberty Select Cyclor contains an internal battery. This battery requires no periodic maintenance and you should not attempt to replace it.



Caution: Your Liberty Select Cyclor is a computer controlled electro-mechanical medical device. It should be installed in an appropriate environment (indoors) free from extremes of temperature and humidity and reasonably protected from dust and dirt contamination or liquid splashes. Failure to install your Liberty Select Cyclor according to these guidelines may result in improper operation or early failure of the device or its parts.



Caution: Use only cyclor tubing sets intended for the Liberty Select Cyclor.



Caution: Use only your fingertips on the Touch Screen and cyclor keys. Use of other objects, such as pens, may result in damage or premature failure.



Caution: The cassette door is pressurized. Do not attempt to open the cassette door until your machine instructs you to do so.



Caution: Use of accessories, transducers and cables other than those provided with your cyclor may result in increased emissions or decreased immunity of the cyclor and result in improper operation.



Caution: In order to prevent potentially hazardous conditions and ensure the safe operation of the Liberty Select Cyclor, Radio Frequency Identification (RFID) Equipment or other RF emitting devices must be kept at least 3 meters from the system while in operation.



Note: Your machine's operation involves fluids: accidental spills can occur. Spills can cause damage to carpeting and other surfaces. To contain such spills, your machine should be on a spill-tolerant surface. Clean up spills immediately.



Note: This User's Guide shows tubing set model 050-87212 which has two stay•safe PIN connectors (sometimes referred to as patient connector) on the patient line. If you use a different tubing set, your PD nurse is responsible for providing alternate instructions.

Fresenius Medical Care manufactures tubing sets for use with the model Liberty Select Cyclor. The performance of tubing sets not manufactured by Fresenius Medical Care cannot be guaranteed by Fresenius Medical Care and are therefore the responsibility of the prescribing doctor or practitioner.



Note: Under normal operating conditions, the expected useful life of the Liberty Select Cyclor is five years.



Note: If it becomes necessary to disconnect, the set in use must have a second unused sterile PIN connector available to resume treatment. After safely disconnecting PIN connector 1, using PIN technology, and attaching a sterile cap to the catheter extension set, prepare and insert the sterile PIN connector (PIN connector 2), so it is ready for reconnection later. If this is not done, there is a chance you could attempt to connect to the used PIN connector (PIN connector 1). This same procedure should also be followed when you perform a Pause exchange. For more information, see page 142.

Meet Your Liberty Select Cycler

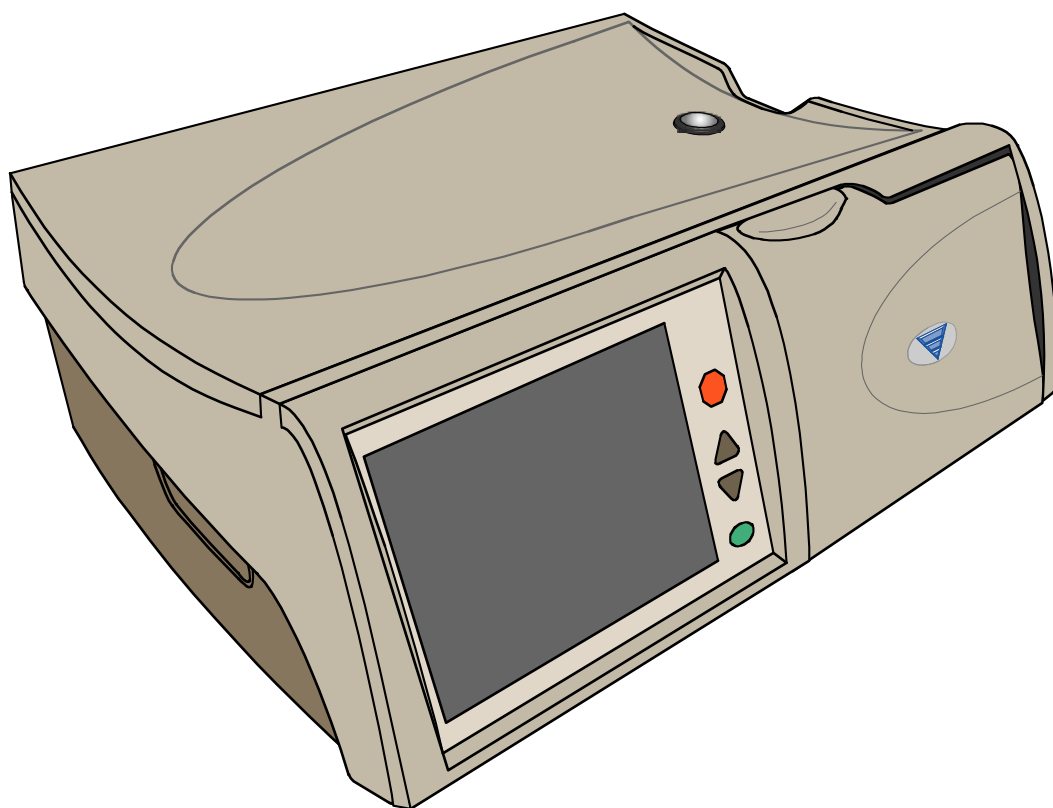

Liberty Select Cyclor Purpose

Your Liberty Select Cyclor helps your body to do the work of your kidneys. Your cyclor pumps dialysate (a cleansing solution used to draw waste products and extra fluids out of your blood) into your empty peritoneal cavity (Fill phase). There it absorbs waste through your body's natural membrane, the peritoneum, over a set amount of time (Dwell phase). When that time is completed, your cyclor drains the waste from your body (Drain phase). Your machine repeats this as often as your doctor or practitioner prescribes. All dialysate and waste pass through a disposable sterile tubing set that is discarded after each treatment.

This User's Guide features treatment walkthroughs for each type of dialysis therapy. Please read the entire User's Guide to learn about the features of your Liberty Select Cyclor before beginning your treatment. For a summary of the types of therapy, please see page 137.

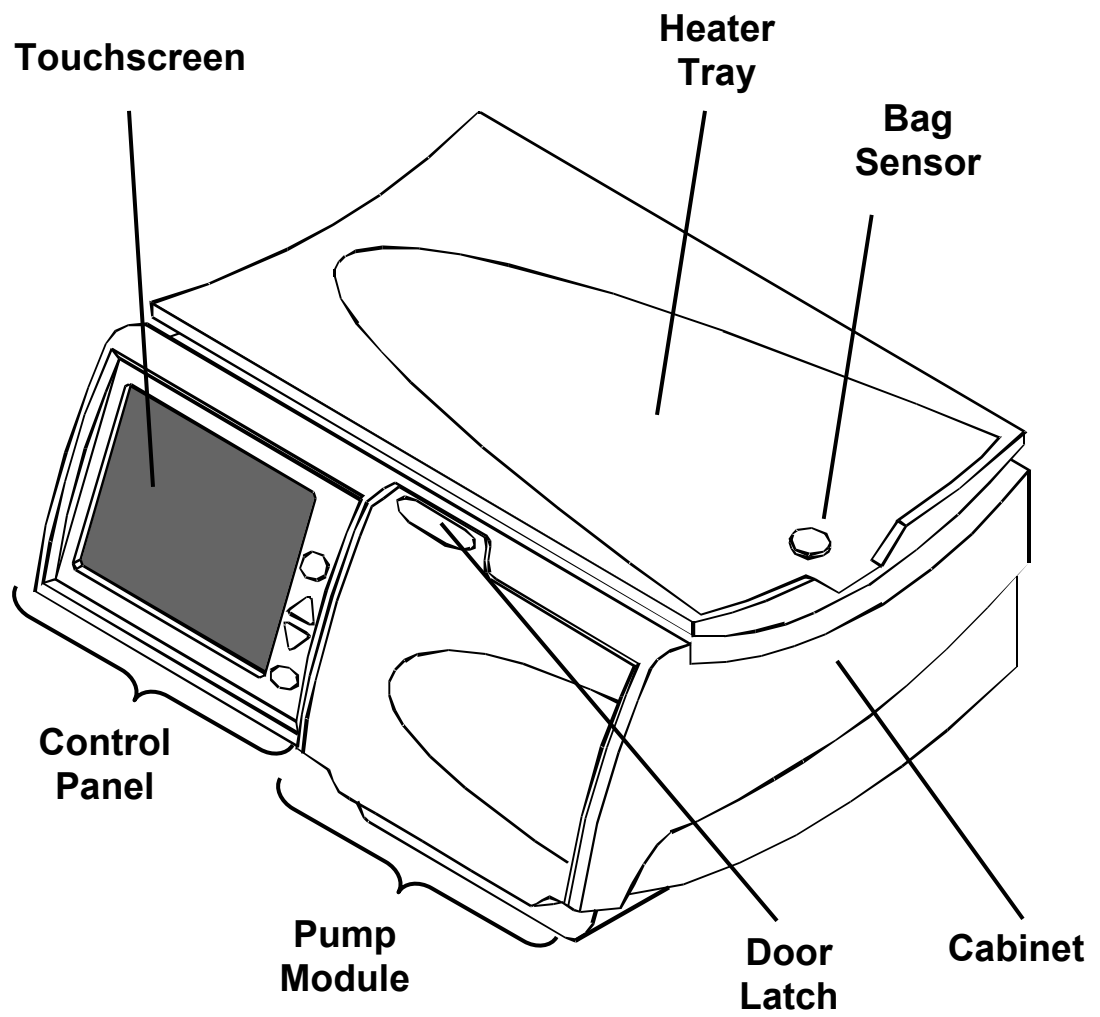

Your Liberty Select Cycler - Front View

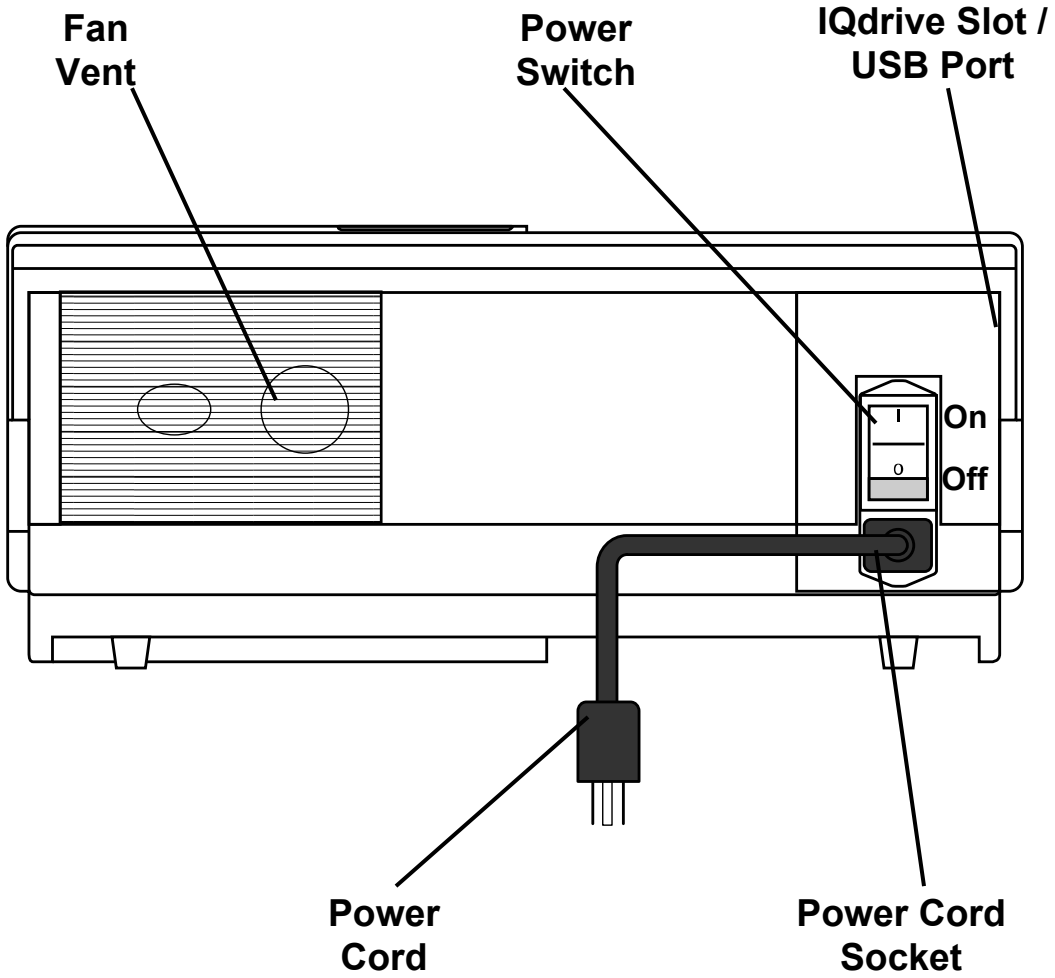

Your Liberty Select Cycler - Rear View

The Control Panel

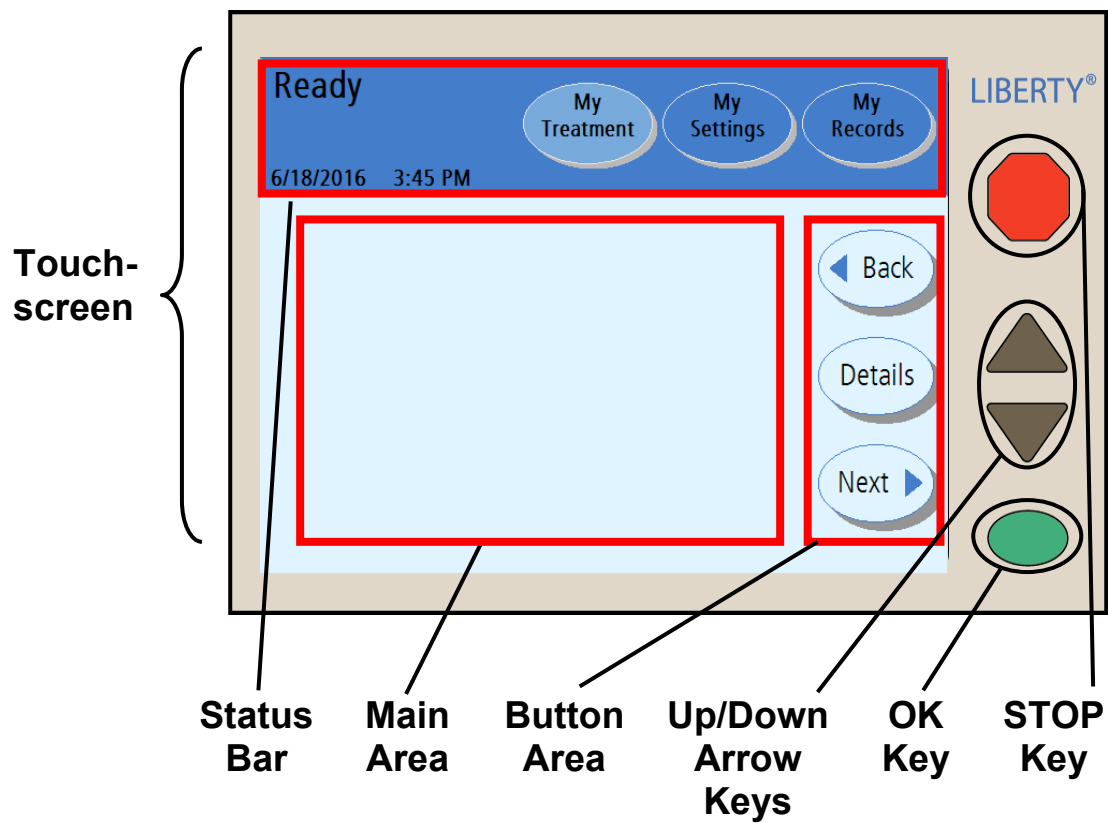

Control Panel

The Control Panel contains all the keys and buttons you need to set up and run your treatment.

Touch Screen

The Touch Screen is a viewing screen that reacts to fingertip pressure. Using the Touch Screen, you may monitor your treatment and select treatment options with Touch Screen Buttons. The different types of Touch Screen Buttons are described on page 30.

Status Bar

See page 28 for a description of the Status Bar.

Main Area

The Touch Screen Main Area shows information and procedures. You may also make treatment selections there.

Button Area

The Button Area contains movement-buttons like **Next**, **Back**, and **Details**.

Up/Down Arrow keys

The **Up/Down Arrow** (▼/▲) keys are used to raise or lower button values.

OK key

The **OK** key confirms Touch Screen selections. In treatment procedures, the **OK** key also moves you to the next step. During certain actions like Drain and Fill, you may use the **OK** key to bypass that action. Press and hold the **OK** key for about four seconds to display the “Bypass” screen. There you may choose to bypass a phase of your treatment or not (see page 190 for instructions on how to perform bypass).

STOP key

The **STOP** key stops functions on your machine. Pressing the **STOP** key during an audible alarm will silence the alarm for ten minutes.

The Status Bar

Ready Support
6/18/2016 3:52 PM

My Treatment My Settings My Records

Flushing
6/18/2016 3:53 PM

My Treatment My Settings My Records

Priming Stopped
6/18/2016 3:55 PM

My Treatment My Settings My Records

Self Test Warning
6/18/2016 4:03 PM

My Treatment My Settings My Records

Treatment Alarm
6/18/2016 4:03 PM

My Treatment My Settings My Records

Status Bar

The Status Bar is located at the top of the Touch Screen. It displays various modes, warnings, alarms, and the date and time. The Status Bar background changes between five different colors to display your machine's conditions (as shown to the left):

Blue

A Blue Status Bar requires you to interact with the machine following prompts to advance the treatment or resolve a support screen message.

Green

A Green Status Bar indicates that your machine is performing an action such as fill, flush, prime, pause, dwell, or drain.

Yellow

The Yellow Status Bar appears whenever you press the **STOP** key during an action (see Green). See "Using the STOP key" on page 182.











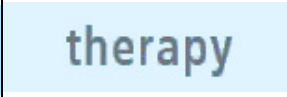

Orange

An Orange Status Bar indicates a warning that needs your immediate attention. During a warning, the screen-buttons are unavailable, all actions stop, and an audible alarm sounds. Press the **STOP** key to silence the alarm.

Red

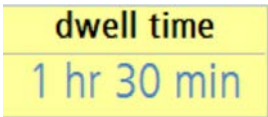
A Red Status Bar indicates an alarm that may be due to a critical fault in your machine. All actions stop, the screen-buttons are unavailable, and an audible alarm sounds. If the Status Bar changes to red, you must stop your treatment and call a Fresenius Medical Care Technical Support Representative at **1-800-227-2572**. For more information on alarms, see "Warnings and Alarms," on page 206.

Touch Screen Buttons

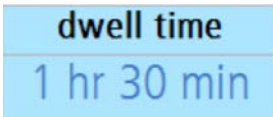
	Normal Bright color or background color	Selected Darker color or lighter background color	Unavailable or Display Only Gray or light blue
Screen -Buttons	 	 	 
Movement -Buttons	 		
Parameter -Buttons	 	 	 



Note: The values shown here are for example only. You must use the values prescribed by your doctor or practitioner.

Buttons Overview

Buttons are shapes with text in them on the Touch Screen. Buttons perform certain actions when touched.

Screen-Buttons

Screen-buttons are oval shaped. They are usually located along the top of the Touch Screen in the Status Bar. Screen-buttons act as a ‘doorway’ to another set of screens. When you touch a screen-button, it turns to a lighter color and its corresponding screen is displayed. Screen-buttons are the same color as the Status Bar’s background. Grayed-out screen-buttons means the functions are unavailable. Screen-buttons also appear in the “Settings” screen as tabs along the top of the Main Area. See the next page for more information about each of the Status Bar screen-buttons.

Movement-Buttons

Movement-buttons are light-blue, oval shaped buttons. They are usually located in the button area of the Touch Screen. Movement-buttons move you from a screen to its sub-screen and back. For example, in a “Treatment” screen, the Details movement-button will move you to a screen showing the “Treatment” screen’s details.

Parameter-Buttons

Parameter-buttons are light yellow rectangles that display treatment values. When you touch a parameter-button, it turns orange, allowing you to edit the parameter it displays. Depending on the button, you may edit that parameter either directly or through another screen using other keys and buttons. Grayed-out parameter-buttons are unavailable options. Blue parameter-buttons are not editable; they display treatment settings affected by other active parameter-buttons.

Navigating With Screen-Buttons

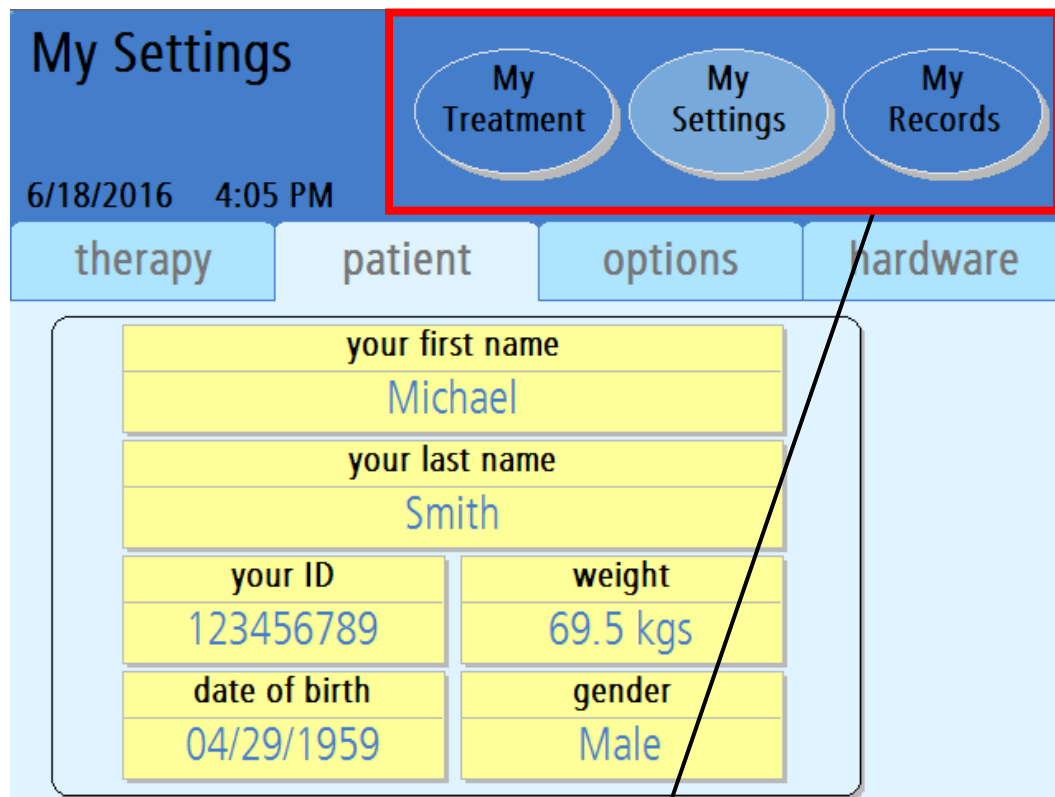

Screen-buttons



Note: The values shown here are for example only. You must use the values prescribed by your doctor or practitioner.

My Treatment

The **My Treatment** screen-button runs your selected treatment procedure. See “Starting Your Treatment,” on page 100, for more information.

My Settings

The **My Settings** screen-button allows you to edit various settings. In the “Settings” screens, you may enter treatment settings, patient information, and software and hardware options. See “Entering Your Treatment Settings,” on pages 49-95, for further instructions.

My Records

The **My Records** screen-button allows you to view your current treatment data and treatment data from past treatments. For more information, see “The My Records Screen-Button,” on page 176.

The Pump Module

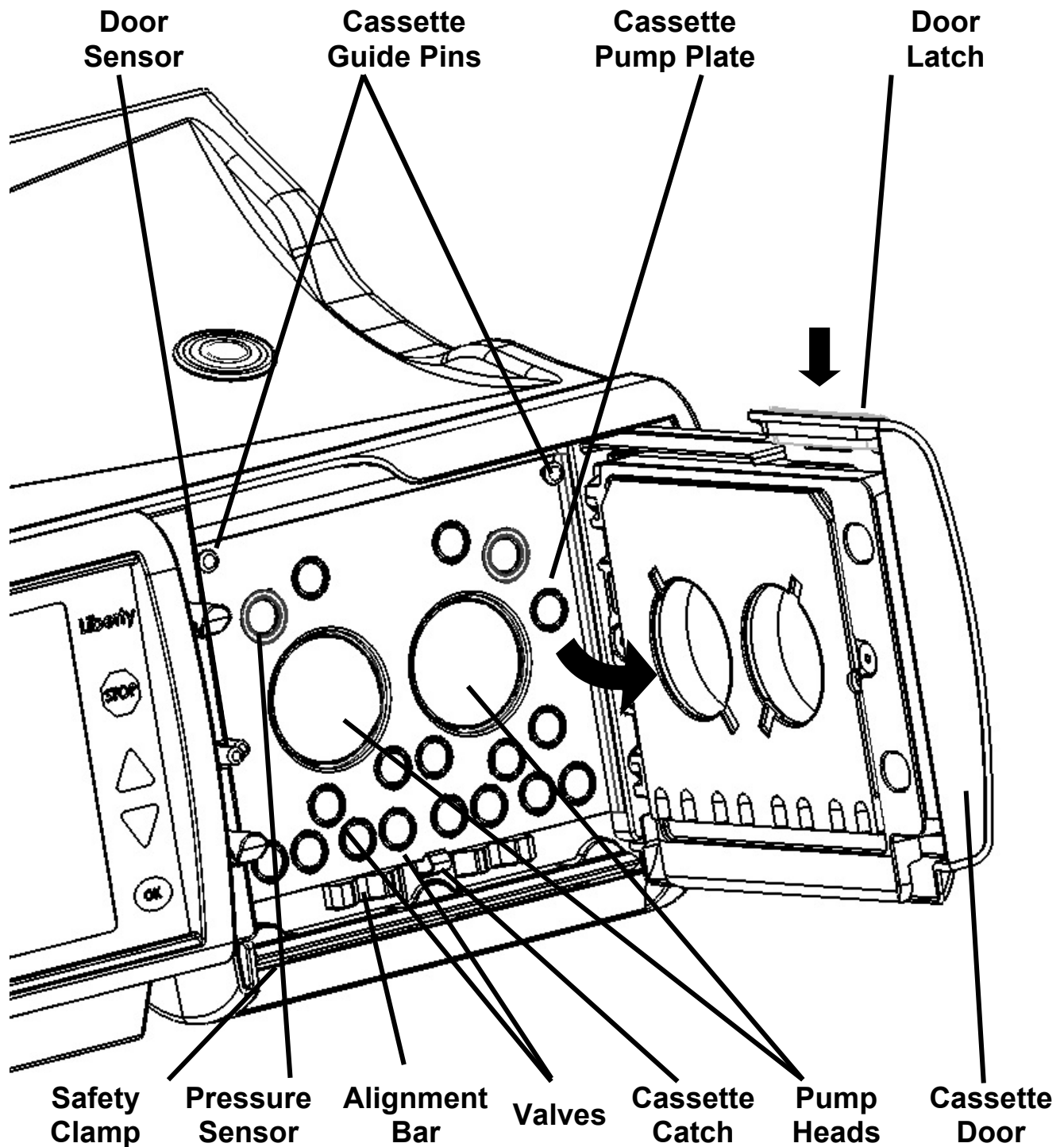

Pump Module

The Pump Module is responsible for moving dialysate solution to and from your body. It controls the valves and pumping chambers in the cassette.

Door Sensor

The Door Sensor tells the machine when the door is open or closed.



Caution: Do not touch the door sensor. Doing so will cause your machine to sense a closed door, pressurizing the cassette door.

Safety Clamp

The Safety Clamp is a metal bar that instantly clamps all the cassette tubing during an alarm or a power failure. If the Safety Clamp is sticking out, you will not be able to insert the cassette properly. Turn the machine off. Wait 10 seconds and turn it back on. This will retract the Safety Clamp, and you can now insert the cassette.

Pressure Sensors

The Cassette Pump Plate also features two white pressure sensors to monitor you during treatment.



Caution: Do not touch the white pressure sensors in the Pump Module. Pressing on the pressure sensors may cause serious damage to them.

Cassette Guide Pins and Cassette Catch

When the cassette is inserted during set up, it fits up and under the cassette guide pins at the top of the Cassette Pump Plate. At the bottom of the Cassette Pump Plate, the Cassette Catch holds the bottom of the cassette in place. The cassette should hang freely from the edge of the Liberty Select Cyler.

Cassette Pump Plate

The Cassette Pump Plate is a thick metal partition. The pumps and valves are located behind the plate and they push through the holes in it to compress the cassette.



Caution: When the cassette is properly inserted in your machine, the domes will face outward. If you insert the cassette in your machine the wrong way, it may damage your machine.

Cassette Door

The Cassette Door holds the cassette in place against the Cassette Pump Plate when locked.

Door Latch

The Door Latch locks the Pump Door. During treatment, do not attempt to unlatch the Pump Door unless instructed to do so.



Warning: Keep fingers clear of moving parts.

This Page is Intentionally Blank

The Cassette and Tubing Set

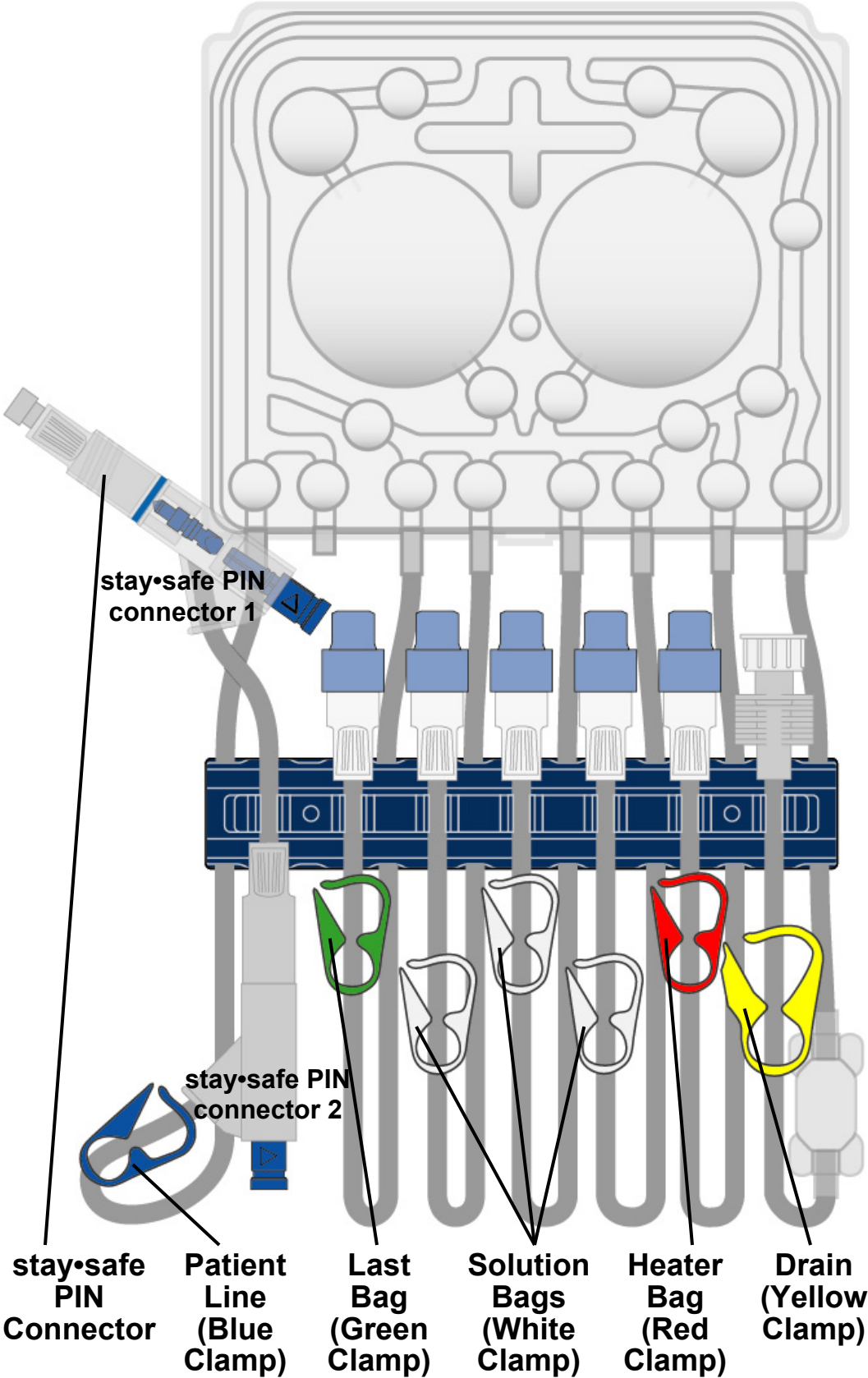

Cassette

All clean dialysate and cleared waste pass through a disposable sterile tubing set that is discarded after each treatment. The hard plastic piece that is inserted into your cyclor is called a cassette. The cassette has two large, plastic domes. When the cyclor pushes in on the membrane behind them, fluid moves through the lines. The cassette also has smaller domes or valves that, when compressed, open or close a fluid pathway.

Below the cassette is an attached tubing set that varies by model number. A dark blue tubing Organizer holds each of the following lines in place while you connect:

stay•safe PIN Connector

The stay•safe PIN connector is located on the end of the Patient Line (blue clamp). Depending upon your clinical needs, you may be prescribed a set with two (2) PIN connectors (PIN connector 1 and PIN connector 2). PIN connector 2 is wrapped in plastic and should be used as instructed by your PD nurse. The PIN connector contains two parts: the blue button and the PIN. When you turn and press the blue button, the PIN inside the connector closes the fluid path to reduce the risk of contamination.

Do not push in the PIN until instructed to do so on the cyclor screen. When instructed, you will turn the blue button on the PIN connector clockwise $\frac{1}{4}$ turn and firmly push it into the PIN connector. The PIN will be released and introduced into the catheter extension set.

Patient Line (blue clamp)

The Patient Line has a blue clamp. It connects to your catheter extension set. **The blue clamp must remain open throughout the cyclor setup and treatment.**

Last Bag Line (green clamp)

The Bag 4 Line has a green clamp. It connects to your last bag if needed. The last bag may be used for more solution or a different solution (with medications added or with a different glucose concentration) for your last fill.

Solution Bag Line 3 (white clamp)

The Bag 3 Line has a white clamp. It connects to your third bag if needed.

Solution Bag Line 2 (white clamp)

The Bag 2 Line has a white clamp. It connects to your second bag if needed.

Solution Bag Line 1 (white clamp)

The Bag 1 Line has a white clamp. It connects to your first bag if needed.

Heater Bag Line (red clamp)

The Heater Bag Line has a red clamp. It connects to the dialysate solution bag on the Heater Tray.



Note: Do not place items other than solution bags on the Heater Tray.

Drain line (yellow clamp)

The Drain Line has a yellow clamp. It connects to your drain line extension or the drain bag set.

This Page is Intentionally Blank

The stay•safe Organizer

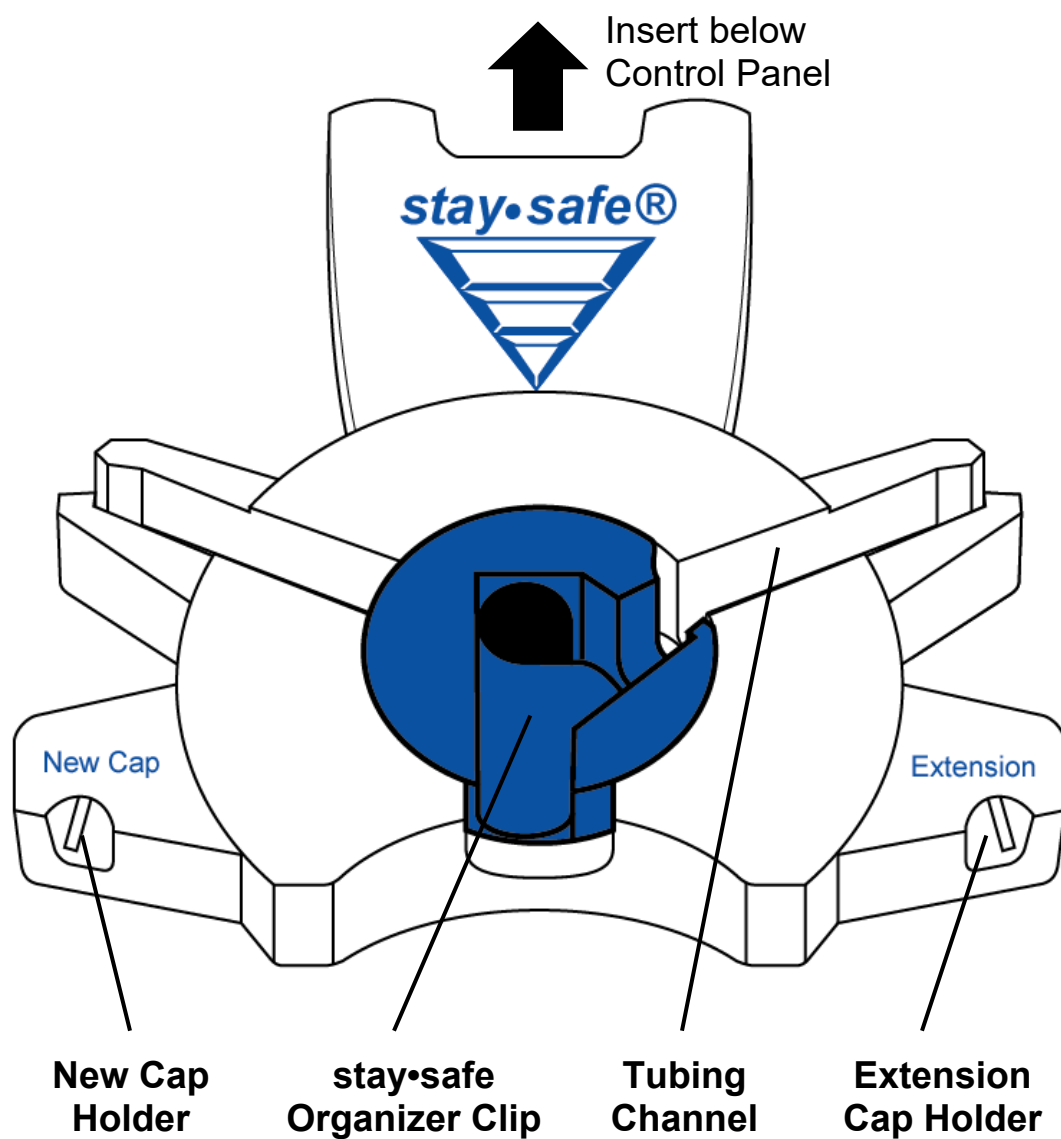

The stay•safe Organizer

Always use aseptic technique during all connections and disconnections to reduce the potential risk of infections. The Liberty Cyclor set includes stay•safe PIN connectors that encourage aseptic technique. Insert the stay•safe Organizer onto the mounting tab on your cyclor below the Control Panel. Your Liberty Cyclor set will be ready to hold your stay•safe PIN connector during your treatment setup. For more information about the stay•safe PIN connector, see page 38.

New Cap Holder

Insert a new stay•safe cap into this holder to keep it clean while using both hands to set up your cyclor for treatment. Always remember to use a new stay•safe cap every time you disconnect yourself from the cyclor.

stay•safe Organizer Clip

The stay•safe PIN connector on the patient line (blue clamp) fits into this holder. The organizer clip keeps it in place so you can connect yourself to it when your cyclor instructs you to. Do not depress the blue button on the PIN connector when placing it into the stay•safe Organizer clip during set up.

Tubing Channel

The tubing channel keeps the Patient Line (blue clamp) in place during set up, connection and disconnection. Be sure to press the tubing in firmly to prevent it from popping out of the tubing channel.

Extension Cap Holder

The Extension Cap Holder is the right notch of the organizer. Place the end of your catheter extension set into the right notch.

The Heater Tray

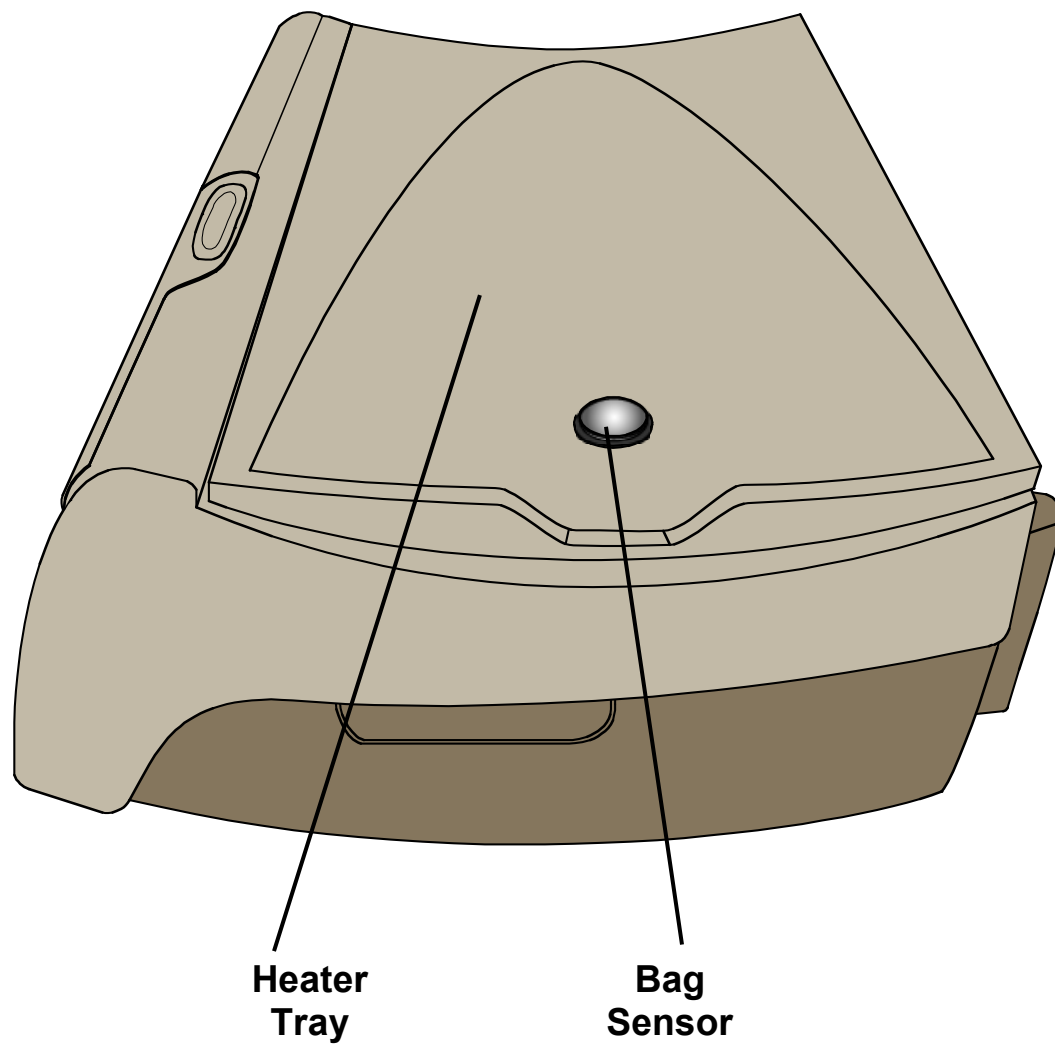

Heater Tray

The Heater Tray warms the dialysate solution-filled heater bag to a set temperature in about 20 minutes (6 L bag may take up to 30 minutes).



Warning: During the heating process, the Heater Tray can get as hot as 50 °C (122 °F). Do not come into contact with the Heater Tray as it may cause injury.



Caution: Do not lift your machine by the heater tray.



Caution: Do not place items other than solution bags on the Heater Tray.

Bag Sensor

The Bag Sensor measures the temperature of the dialysate solution in the heater bag.

Setting up Your Liberty Select Cyclor

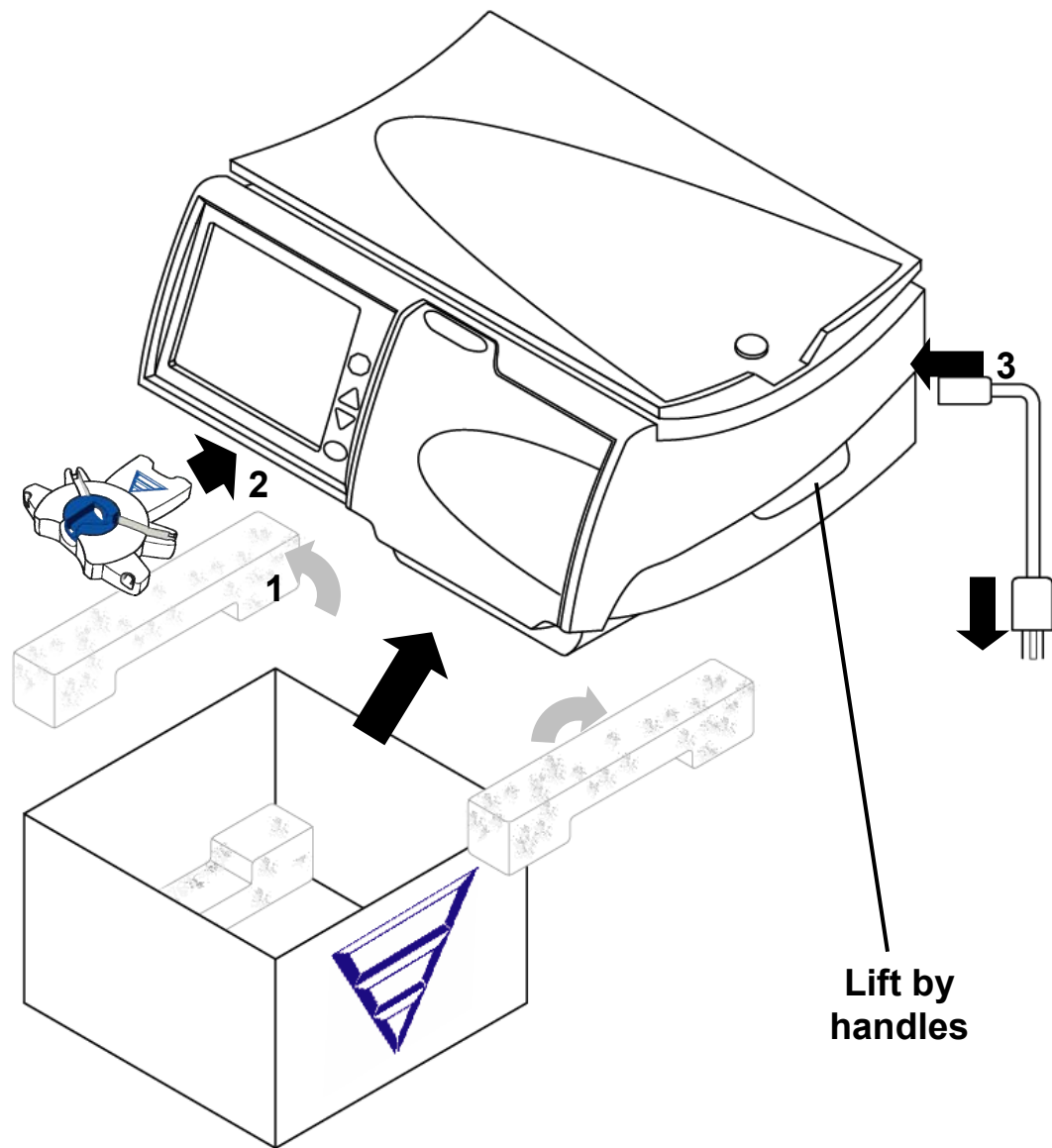

Setting up your Liberty Select Cyclor

Your Liberty Select Cyclor is easy to set up. Follow the instructions below:

1 Remove your Liberty Select Cyclor from box

- Pull out the blue foam.
- Pull dust cover aside.
- Pick up your cyclor by both handles on either side.
- Carefully lift your cyclor out of its shipping box. Set it on a stable, level surface such as a table with the screen facing you.
- Keep all foam and packaging in case your cyclor needs to be repacked.
- Position your cyclor near the edge of the table or Liberty cart so the tubing from the cassette will be able to hang down without kinking.
- Make sure that the top of the cyclor is no more than 12 inches higher or lower than your bed.
- Make sure the cyclor is not close to a heating or cooling source.



Warning: Use proper lifting techniques: lift with your knees and not your back.



Caution: Do not lift your machine by the heater tray.



Caution: Make certain the vent on the back of your machine is free of obstructions.

2 Connect stay•safe Organizer

Push the stay•safe Organizer onto the mounting tab below the Control Panel.

3 Plug in machine

Plug the machine end of the power cord firmly into the power socket on the back of your machine. Plug the outlet end of the cord into a 120V three-prong power outlet. See page 50 for a picture of the back of your machine.



Warning: If you are unable to insert the plug in its socket and an outlet, contact a Fresenius Medical Care Technical Support Representative at **1-800-227-2572**. Do not alter the power cord. Do not use the power cord if broken or damaged. Your machine must be plugged directly into the electrical outlet; do not use extension cords or power strips.

My Settings

Entering Your Prescription

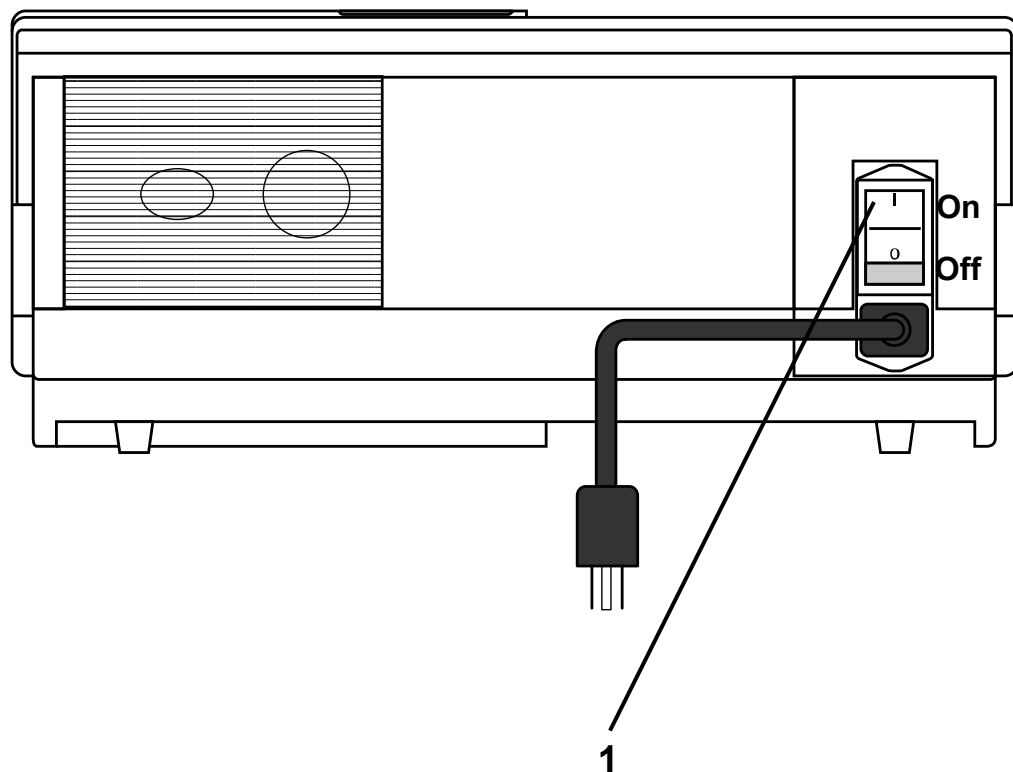

Entering your prescription

Before you start your first treatment, you or your PD Nurse will need to enter the treatment settings (your prescription) that your doctor or practitioner has prescribed. You do not need to do this again unless your prescription changes.

If your PD nurse has provided an IQdrive to you and the USB enabled option is set to **YES** (see “Options Settings,” on page 86), you may insert the IQdrive into the back of your machine at this time. See “Using the IQdrive,” on page 194 for more information about inserting the IQdrive.

The numbered items in the picture on the left match the numbered steps listed on this page. Do each step in order and pay close attention to Note, Caution, and Warning statements.

1 Turn power switch to ON

Locate the white power switch on the back of your machine and set it to the ON position. The “Ready” screen will appear on the Touch Screen shortly.

Entering Your Treatment Settings

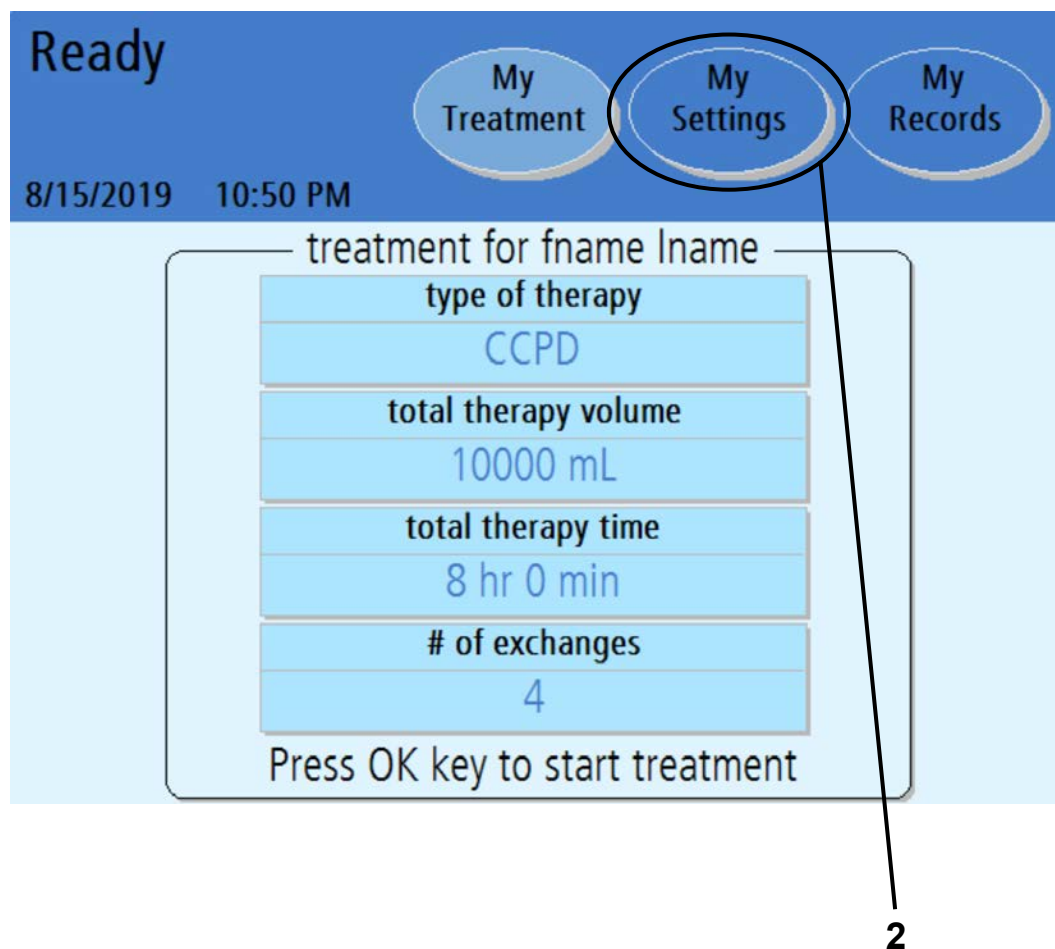

Note: The values shown here are for example only. You must use the values prescribed by your doctor or practitioner.



Note: If your name and treatment settings are already displayed on this screen, you do not need to enter them again. Check that the values match your prescription. You may begin your treatment by turning to page 98.

2 Touch **My Settings**

The first time you start your machine, the “Ready” screen will display default treatment values for an “Unknown” patient. Default treatment values are a preselected option by the manufacturer and may not match the patient’s prescription.

Before starting your first treatment on the cyclor, a prescription must be entered. The prescription can be manually entered or transferred from an IQdrive. Use the treatment settings from the “My Treatment settings” sheet on page 6 or follow your PD nurse’s instructions.

To manually enter your treatment settings, touch the **My Settings** screen-button. You will then go to the “My Settings” screen.



Note: If the ‘USB enabled’ option under “My Settings: Options” is set to YES and an IQdrive is correctly inserted into the IQdrive slot on your cyclor, this screen might not be immediately displayed. See “Using the IQdrive,” on page 194 for more information.



Note: If the USB enabled option is set to YES but an IQdrive is not inserted into the IQdrive slot on your cyclor, your treatment data will be saved only to your cyclor.



Note: If you are using the IQdrive to program your treatment, you do not need to enter your therapy information. Turn to page 76 to enter your patient, options, and hardware settings.

Select Therapy Tab

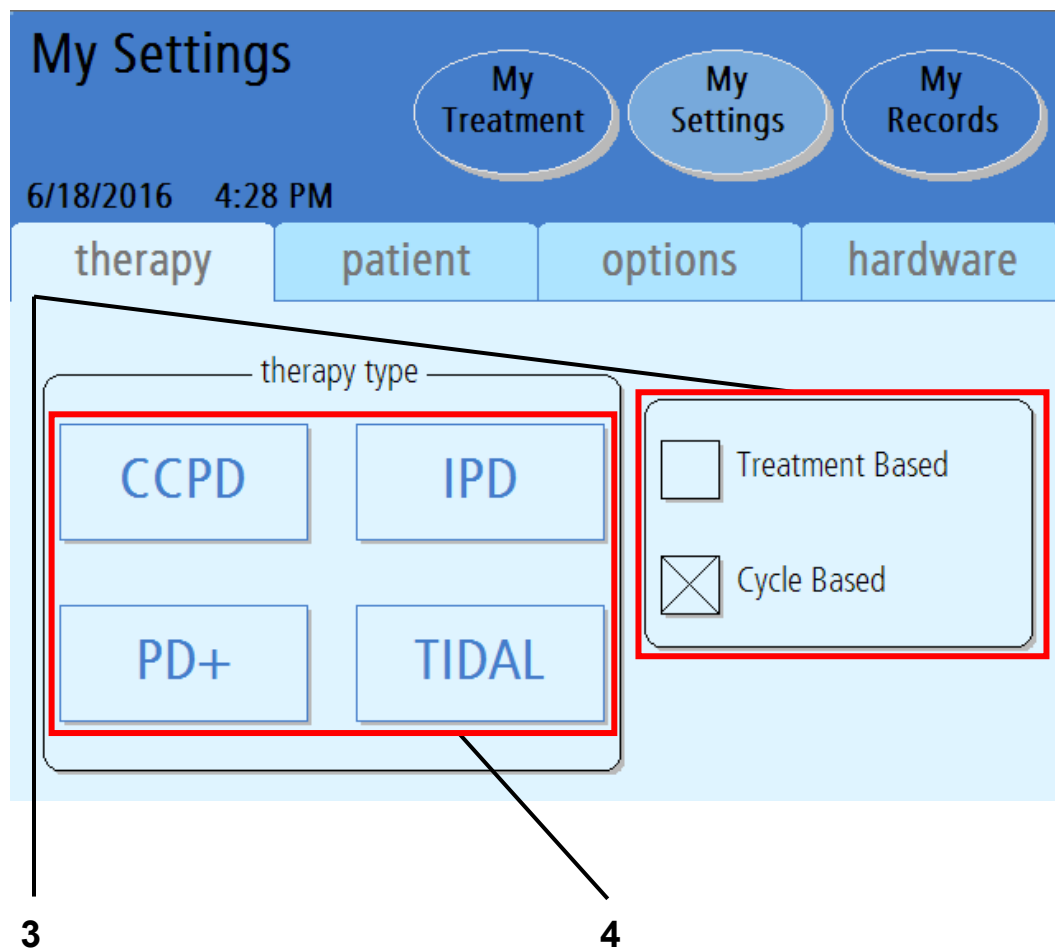

Note: The values shown here are for example only. You must use the values prescribed by your doctor or practitioner.

3 Select Treatment based or Cycle based program mode

The “My Settings” screen displays your available therapy options.

Touch the program mode your prescription is based upon: Cycle based or Treatment based. A large ‘X’ will indicate the selected program mode.

Treatment Based means that you set your total treatment time. Your cycler will deliver your treatment in the specified amount of time. This program mode is useful for patients that need to finish treatment by a certain time in order to meet obligations such as going to work.

Cycle Based means that your cycler will always dwell for the amount of time you set. Your total treatment time may vary depending on how you drain and fill or if you have any alarms.

Patients may experience fewer drain complication alarms using Treatment Based than Cycle Based therapy. If you are in Cycle Based therapy and experiencing drain complications you may want to discuss switching therapy types with your doctor, practitioner, or PD nurse.

4 Select therapy type

Touch the button matching your prescribed treatment. You will then move to the corresponding screen. Turn to the corresponding page listed below:

- **CCPD: Treatment Based**—Turn to page 56
- **CCPD: Cycle Based**—Turn to page 58
- **IPD: Treatment Based**—Turn to page 60
- **IPD: Cycle Based**—Turn to page 62
- **PD+: Treatment Based**—Turn to page 64
- **PD+: Cycle Based**—Turn to page 66
- **TIDAL: Treatment Based**—Turn to page 68
- **TIDAL: Cycle Based**—Turn to page 72

See page 136 for information on the different therapy types.



Warning: The values and selections shown in pictures here are for example only. You must enter the values prescribed by your doctor or practitioner; see “My Treatment Settings,” page 6.

CCPD: Treatment-Based Settings

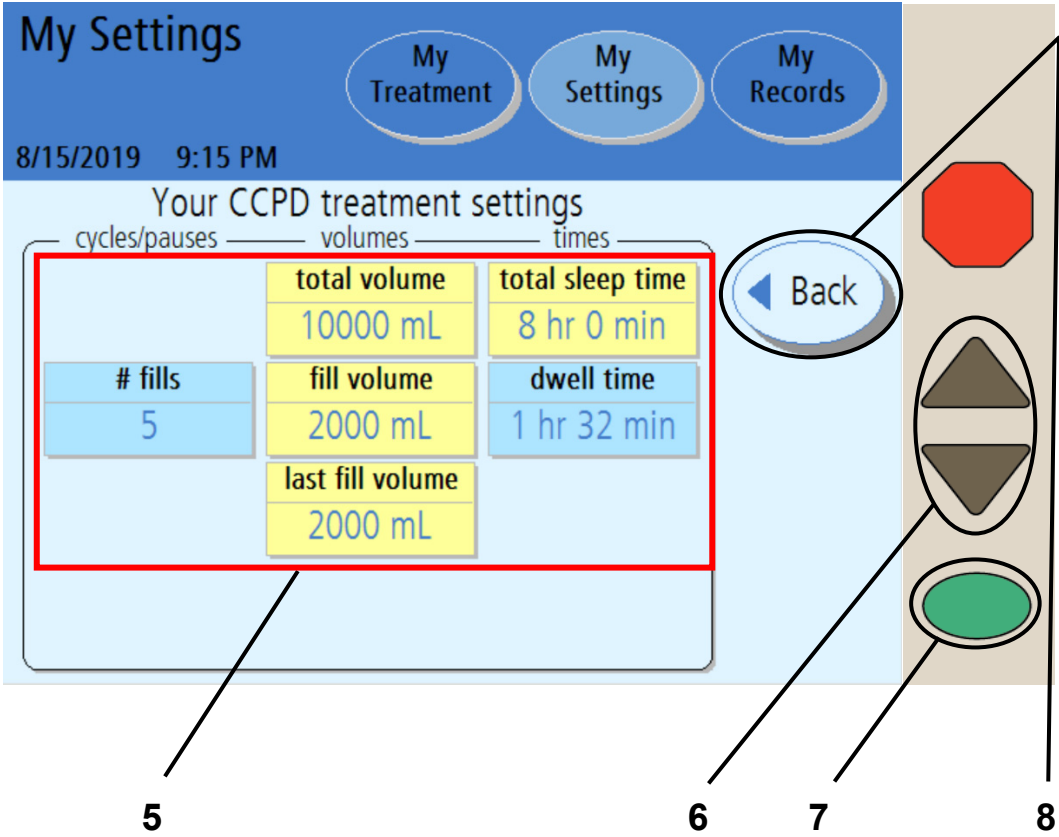

 **Note:** The values shown here are for example only. You must use the values prescribed by your doctor or practitioner.



Note: If your prescription is for cycle-based therapy, this screen will display different options. Turn to page 58 for cycle-based CCPD.

5 Select values

Touch the yellow button to select the value it displays:

- **Total volume**—The amount of dialysate used for your entire treatment
- **Fill volume**—The amount of every Fill (except last)
- **Last fill volume**—The amount of your Last Fill (this is optional and may be set to zero per the physician prescription)
- **Total sleep time**—Estimated sum of all Drain, Fill, and Dwell time during the treatment



Note: Light blue buttons cannot be selected. Your machine calculates the values in blue buttons based on the values you enter in the yellow buttons.



Note: If you need to set the last bag option, see “Options Settings,” on page 86.

6 Enter values

When you touch a yellow button, it will turn orange. Use the **Up/Down Arrow** (▼/▲) keys to set it to your prescribed value.

Repeat these steps to enter all of your prescribed values.

7 Press **OK**

Press the **OK** key to confirm and save your settings.

8 Touch **Back**

Touch the **Back** button to return to the “My Settings” main screen.

Skip to page 76 to enter your personal Patient Settings.

CCPD: Cycle-Based Settings

The screenshot shows the 'My Settings' interface. At the top, there are three navigation buttons: 'My Treatment', 'My Settings', and 'My Records'. Below this is the date and time: '8/15/2019 9:31 PM'. The main heading is 'Your CCPD treatment settings'. A table of settings is displayed, with a red box highlighting the first three rows. To the right of the table is a 'Back' button. Further right are physical controls: a red stop button, two triangular buttons (up and down), and a green button. Lines connect these elements to numbers 5, 6, 7, and 8 at the bottom of the page.

cycles/pauses	volumes	times
# fills	fill volume	dwelt time
5	2000 mL	1 hr 10 min
		fill time
		0 hr 20 min
	last fill volume	drain time
	2000 mL	0 hr 20 min
	total volume	total sleep time
	10000 mL	8 hr 0 min



Note: The values shown here are for example only. You must use the values prescribed by your doctor or practitioner.



Note: If your prescription is for treatment-based therapy, this screen will display different options. Turn to page 56 for treatment-based CCPD.

5 Select values

Touch the yellow button to select the value it displays:

- **# fills**—Number of Fills during treatment
- **Fill volume**—The amount of every Fill (except last)
- **Last fill volume**—The amount of your Last Fill (this is optional and may be set to zero per the physician prescription)
- **Dwell time**—The amount of time the dialysate dwells in you
- **Fill time**—The amount of time available to fill you
- **Drain time**—The amount of time available to drain you after a Dwell



Note: Light blue buttons cannot be selected. Your machine calculates the values in blue buttons based on the values you enter in the yellow buttons.



Note: If you need to set the last bag option, see “Options Settings,” on page 86.

6 Enter values

When you touch a yellow button, it will turn orange. Use the **Up/Down Arrow** (▼/▲) keys to set it to your prescribed value.

Repeat these steps to enter all of your prescribed values.

7 Press

Press the **OK** key to confirm and save your settings.

8 Touch

Touch the **Back** button to return to the “My Settings” main screen.

Skip to page 76 to enter your personal Patient Settings.

IPD: Treatment-Based Settings

My Settings

My Treatment My Settings My Records

8/15/2019 9:16 PM

Your IPD treatment settings

cycles/pauses	volumes	times
	total volume	total sleep time
	10000 mL	8 hr 0 min
# fills	fill volume	dwel time
4	2500 mL	1 hr 32 min
# pauses	pause volume	
0	N/A	

Back

5 6 7 8

 **Note:** The values shown here are for example only. You must use the values prescribed by your doctor or practitioner.



Note: If your prescription is for cycle-based therapy, this screen will display different options. Turn to page 62 for cycle-based IPD.

5 Select values

Touch the yellow button to select the value it displays:

- **# pauses**—Number of Pauses during treatment (this is optional and may be set to zero per the physician prescription)
- **Total volume**—The amount of dialysate used for your entire treatment
- **Fill volume**—The amount of every Fill
- **Pause volume**—How much you are to be filled with each Pause
- **Total sleep time**—Estimated sum of all Drain, Fill, and Dwell time during your treatment



Note: Light blue buttons cannot be selected. Your machine calculates the values in blue buttons based on the values you enter in the yellow buttons.



Note: If you need to set the last bag option, see “Options Settings,” on page 86.

6 Enter values

When you touch a yellow button, it will turn orange. Use the **Up/Down Arrow (▼/▲)** keys to set it to your prescribed value.

Repeat these steps to enter all of your prescribed values.

7 Press **OK**

Press the **OK** key to confirm and save your settings.

8 Touch **Back**

Touch the **Back** button to return to the “My Settings” main screen.

Skip to page 76 to enter your personal Patient Settings.

IPD: Cycle-Based Settings

My Settings

My Treatment My Settings My Records

8/15/2019 9:34 PM

Your IPD treatment settings

cycles/pauses	volumes	times
# fills	fill volume	dwel time
5	2500 mL	1 hr 15 min
# pauses	pause volume	fill time
0	N/A	0 hr 20 min
		drain time
		0 hr 25 min
total volume		total sleep time
10000 mL		8 hr 0 min

Back

5 6 7 8

Note: The values shown here are for example only. You must use the values prescribed by your doctor or practitioner.



Note: If your prescription is for treatment-based therapy, this screen will display different options. Turn to page 60 for treatment-based IPD.

5 Select values

Touch the yellow button to select the value it displays:

- **# fills**—Number of Fills during treatment
- **# pauses**—Number of Pauses during treatment (this is optional and may be set to zero per the physician prescription)
- **Fill volume**—The amount of every Fill
- **Pause volume**—How much you are to be filled with each Pause
- **Dwell time**—The amount of time the dialysate dwells in you
- **Fill time**—The amount of time available to fill you
- **Drain time**—The amount of time available to drain you after a Dwell



Note: Light blue buttons cannot be selected. Your machine calculates the values in blue buttons based on the values you enter in the yellow buttons.

6 Enter values

When you touch a yellow button, it will turn orange. Use the **Up/Down Arrow (▼/▲)** keys to set it to your prescribed value.

Repeat these steps to enter all of your prescribed values.

7 Press **OK**

Press the **OK** key to confirm and save your settings.

8 Touch **Back**

Touch the **Back** button to return to the “My Settings” main screen.

Skip to page 76 to enter your personal Patient Settings.

PD+: Treatment-Based Settings

My Settings

8/15/2019 9:19 PM

Your PD+ treatment settings

cycles/pauses	volumes	times
	total volume	total sleep time
	11500 mL	8 hr 0 min
# fills	fill volume	
5	2500 mL	
# pauses	pause volume	dwell time
1	2000 mL	1 hr 57 min
	last fill volume	
	2000 mL	

5

6

7

8

Note: The values shown here are for example only. You must use the values prescribed by your doctor or practitioner.



Note: If your prescription is for cycle-based therapy, this screen will display different options. Turn to page 66 for cycle-based PD+.

5 Select values

Touch the yellow button to select the value it displays:

- **# pauses**—Number of Pauses during treatment (this is optional and may be set to zero per the physician prescription)
- **Total volume**—The amount of dialysate used for your entire treatment
- **Fill volume**—The amount of every Fill (except last)
- **Pause volume**—How much you are to be filled with each Pause
- **Last fill volume**—The amount of your Last Fill (this is optional and may be set to zero per the physician prescription)
- **Total sleep time**—Estimated sum of all Drain, Fill, and Dwell time during your treatment



Note: Light blue buttons cannot be selected. Your machine calculates the values in blue buttons based on the values you enter in the yellow buttons.



Note: If you need to set the last bag option, see “Options Settings,” on page 86.

6 Enter values

When you touch a yellow button, it will turn orange. Use the **Up/Down Arrow (▼/▲)** keys to set it to your prescribed value.

Repeat these steps to enter all of your prescribed values.

7 Press **OK**

Press the **OK** key to confirm and save your settings.

8 Touch **Back**

Touch the **Back** button to return to the “My Settings” main screen.

Skip to page 76 to enter your personal Patient Settings.

PD+: Cycle-Based Settings

My Settings

8/15/2019 9:37 PM

Your PD+ treatment settings

# fills	fill volume	dwelt time
5	2500 mL	1 hr 25 min
# pauses	pause volume	fill time
1	2000 mL	0 hr 20 min
	last fill volume	drain time
	2000 mL	0 hr 25 min
	total volume	total sleep time
	11500 mL	8 hr 0 min

5

6

7

8

i **Note:** The values shown here are for example only. You must use the values prescribed by your doctor or practitioner.



Note: If your prescription is for treatment-based therapy, this screen will display different options. Turn to page 64 for treatment-based PD+.

5 Select values

Touch the yellow button to select the value it displays:

- **# fills**—Number of Fills during treatment
- **# pauses**—Number of Pauses during treatment (this is optional and may be set to zero per the physician prescription)
- **Fill volume**—The amount of every Fill (except last)
- **Pause volume**—How much you are to be filled with each Pause
- **Last fill volume**—The amount of your Last Fill (this is optional and may be set to zero per the physician prescription)
- **Dwell time**—The amount of time the dialysate dwells in you
- **Fill time**—The amount of time available to fill you
- **Drain time**—The amount of time available to drain you after a Dwell



Note: Light blue buttons cannot be selected. Your machine calculates the values in blue buttons based on the values you enter in the yellow buttons.



Note: If you need to set the last bag option, see “Options Settings,” on page 86.

6 Enter values

When you touch a yellow button, it will turn orange. Use the **Up/Down Arrow** (▼/▲) keys to set it to your prescribed value.

Repeat these steps to enter all of your prescribed values.

7 Press **OK**

Press the **OK** key to confirm and save your settings.

8 Touch **Back**

Touch the **Back** button to return to the “My Settings” main screen.

Skip to page 76 to enter your personal Patient Settings.

Tidal: Treatment-Based Settings

The screenshot displays the 'My Settings' interface for a Tidal device. At the top, there are three tabs: 'My Treatment', 'My Settings', and 'My Records'. The date and time are shown as 8/15/2019 9:26 PM. The main heading is 'Your Tidal treatment settings'. Below this, there are three columns of settings: 'cycles/pauses', 'volumes', and 'times'. A red box highlights the 'cycles/pauses' column, which includes '# pauses' (0) and '# fills' (5). The 'volumes' column includes 'total volume' (9250 mL), 'pause volume' (N/A), and 'first fill volume' (2000 mL). The 'times' column includes 'total sleep time' (8 hr 0 min) and 'dwell time' (1 hr 33 min). To the right of the settings table are navigation buttons: 'Back' (left arrow), 'Next' (right arrow), and a vertical stack of three buttons: a red stop sign, a brown up/down arrow, and a green circle. Lines connect the numbers 5, 6, 7, and 8 to the '# fills', 'Next', green circle, and red stop sign buttons, respectively.

cycles/pauses	volumes	times
	total volume	total sleep time
	9250 mL	8 hr 0 min
# pauses	pause volume	
0	N/A	
	first fill volume	
	2000 mL	
# fills	tidal fill volume	dwell time
5	1750 mL	1 hr 33 min



Note: The values shown here are for example only. You must use the values prescribed by your doctor or practitioner.



Note: If your prescription is for cycle-based therapy, this screen will display different options. Turn to page 72 for cycle-based TIDAL.

5 Select values

Touch the yellow button to select the value it displays:

- **# pauses**—Number of Pauses during treatment (this is optional and may be set to zero per the physician prescription)
- **Total volume**—The amount of dialysate used for your entire treatment
- **Pause volume**—How much you are to be filled with each Pause
- **First fill volume**—The amount of your First Fill
- **Tidal fill volume**—How much you are to be filled each exchange
- **Total sleep time**—Estimated sum of all Drain, Fill, and Dwell time during your treatment



Note: Light blue buttons cannot be selected. Your machine calculates the values in blue buttons based on the values you enter in the yellow buttons.

6 Enter values

When you touch a yellow button, it will turn orange. Use the **Up/Down Arrow (▼/▲)** keys to set it to your prescribed value.

Repeat these steps to enter all of your prescribed values.

7 Press

Press the **OK** key to confirm and save your settings.

8 Touch

Touch the **Next** button to continue to the next screen to finish entering prescribed values.

Tidal: Treatment-Based Settings (continued)

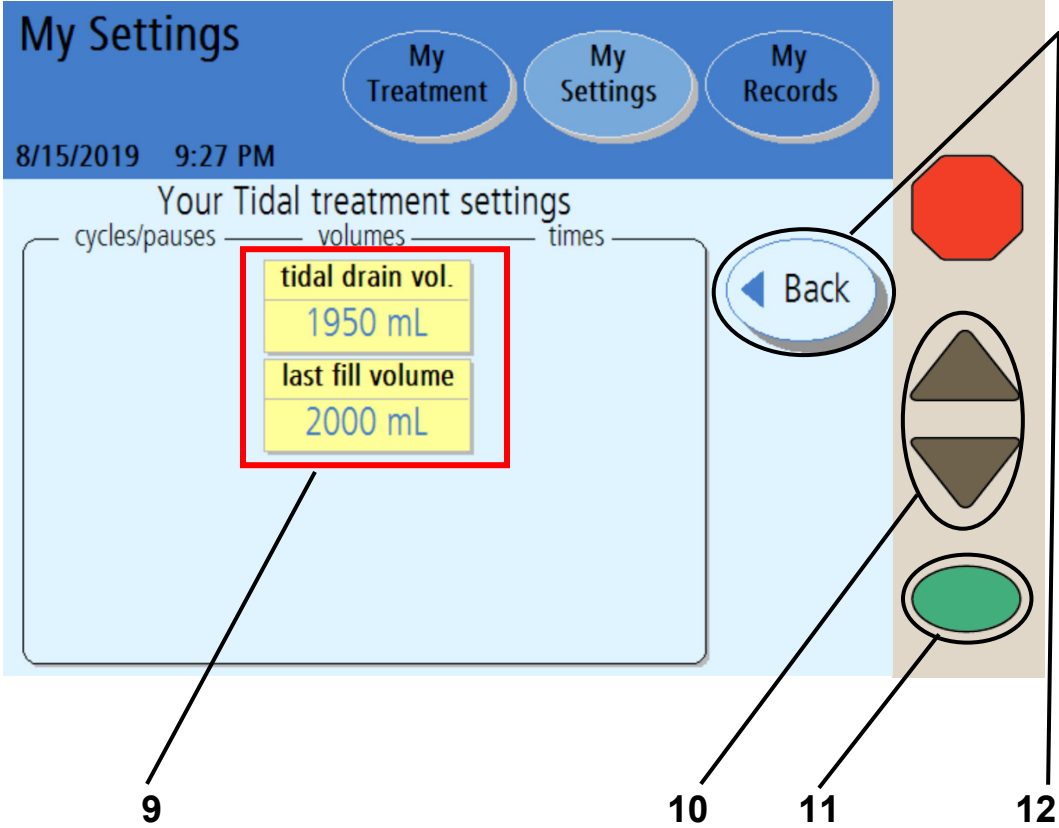

i **Note:** The values shown here are for example only. You must use the values prescribed by your doctor or practitioner.

9 Select values

Touch the yellow button to select the value it displays:

- **Tidal drain volume**—How much you are to be drained each exchange
- **Last fill volume**—The amount of your Last Fill (this is optional and may be set to zero per the physician prescription)



Warning: Your Tidal Drain Volume must include your Tidal Fill Volume plus your expected ultrafiltration (UF) per cycle, which is based on an average daily UF volume from the Tidal Dwell in order to prevent an overflow situation. Overflowing can cause serious injury or death. For more information on overflowing, see page 190.



Note: Light blue buttons cannot be selected. Your machine calculates the values in blue buttons based on the values you enter in the yellow buttons.



Note: If you need to set the last bag option, see “Options Settings,” on page 86.

10 Enter values

When you touch a yellow button, it will turn orange. Use the **Up/Down Arrow** (▼/▲) keys to set it to your prescribed value.

Repeat these steps to enter all of your prescribed values.

11 Press **OK**

Press the **OK** key to confirm and save your settings.

12 Touch **Back**

Touch the **Back** button to return to the previous screen, then touch the **Back** button again to reach the “My Settings” main screen.

Skip to page 76 to enter your personal Patient Settings.

Tidal: Cycle-Based Settings

My Settings

My Treatment My Settings My Records

8/15/2019 9:41 PM

Your Tidal treatment settings

cycles/pauses	volumes	times
# pauses	pause volume	dwelling time
0	N/A	1 hr 10 min
	first fill volume	fill time
	2000 mL	0 hr 20 min
# fills	tidal fill volume	drain time
5	1750 mL	0 hr 20 min
	total volume	total sleep time
	9250 mL	8 hr 0 min

Back

Next

5 6 7 8

i **Note:** The values shown here are for example only. You must use the values prescribed by your doctor or practitioner.



Note: If your prescription is for treatment-based therapy, this screen will display different options. Turn to page 68 for treatment-based Tidal.

5 Select values

Touch the yellow button to select the value it displays:

- **# pauses**—Number of Pauses during treatment (this is optional and may be set to zero per the physician prescription)
- **# fills**—Number of Fills during treatment
- **Pause volume**—How much you are to be filled with each Pause
- **First fill volume**—The amount of your First Fill
- **Tidal fill volume**—How much you are to be filled each exchange
- **Dwell time**—The amount of time the dialysate dwells in you
- **Fill time**—The amount of time available to fill you
- **Drain time**—The amount of time available to Drain you after a Dwell



Note: Light blue buttons cannot be selected. Your machine calculates the values in blue buttons based on the values you enter in the yellow buttons.

6 Enter values

When you touch a yellow button, it will turn orange. Use the **Up/Down Arrow** (▼/▲) keys to set it to your prescribed value.

Repeat these steps to enter all of your prescribed values.

7 Press **OK**

Press the **OK** key to confirm and save your settings.

8 Touch **Next**

Touch the **Next** button to continue to the next screen to finish entering prescribed values.

Tidal: Cycle-Based Settings (continued)

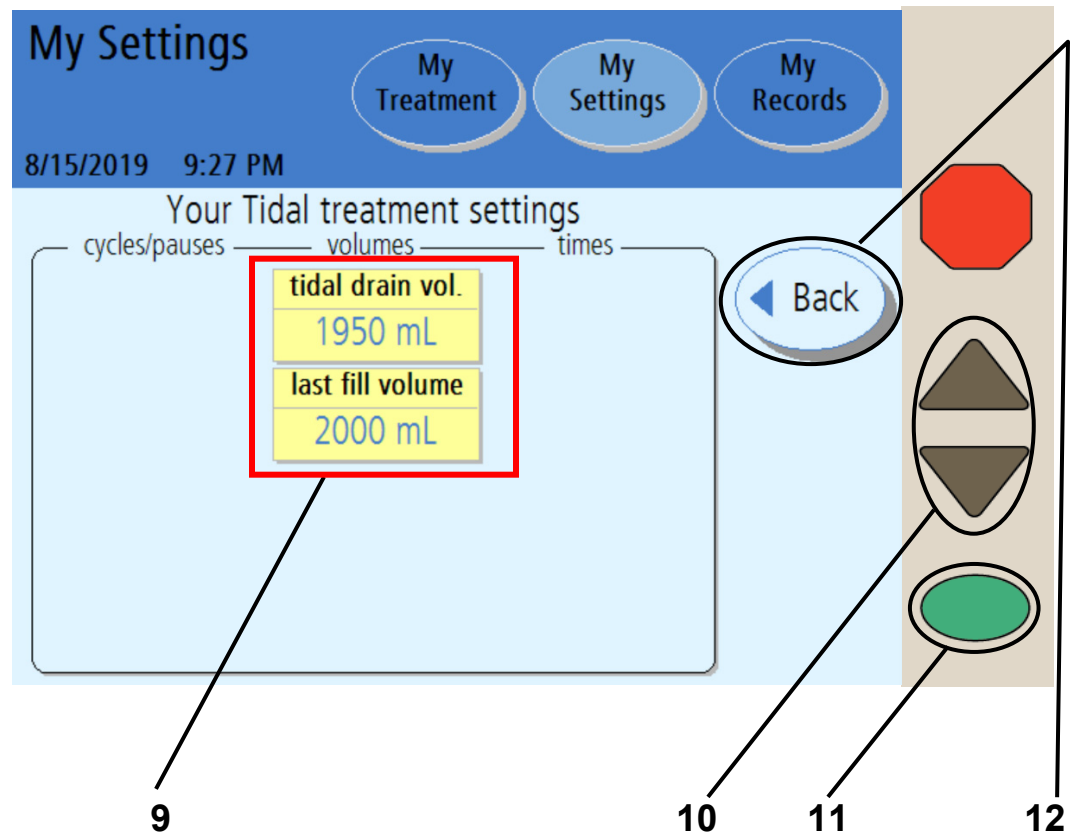

Note: The values shown here are for example only. You must use the values prescribed by your doctor or practitioner.

9 Select values

Touch the yellow button to select the value it displays:

- **Tidal drain volume**—How much you are to be drained each exchange
- **Last fill volume**—The amount of your Last Fill (this is optional and may be set to zero per the physician prescription)



Warning: Your Tidal Drain Volume must include your Tidal Fill Volume plus your expected ultrafiltration (UF), which is based on an average daily UF volume from the Tidal Dwell in order to prevent an overflow situation. Overflowing can cause serious injury or death. For more information on overflowing, see page 190.



Note: Light blue buttons cannot be selected. Your machine calculates the values in blue buttons based on the values you enter in the yellow buttons.



Note: If you need to set the last bag option, see “Options Settings,” on page 86.

10 Enter values

When you touch a yellow button, it will turn orange. Use the **Up/Down Arrow** (▼/▲) keys to set it to your prescribed value.

Repeat these steps to enter all of your prescribed values.

11 Press

Press the **OK** key to confirm and save your settings.

12 Touch

Touch the **Back** button to return to the previous screen, then touch the **Back** button again to reach the “My Settings” main screen.

Skip to page 76 to enter your personal Patient Settings.

Patient Settings Tab

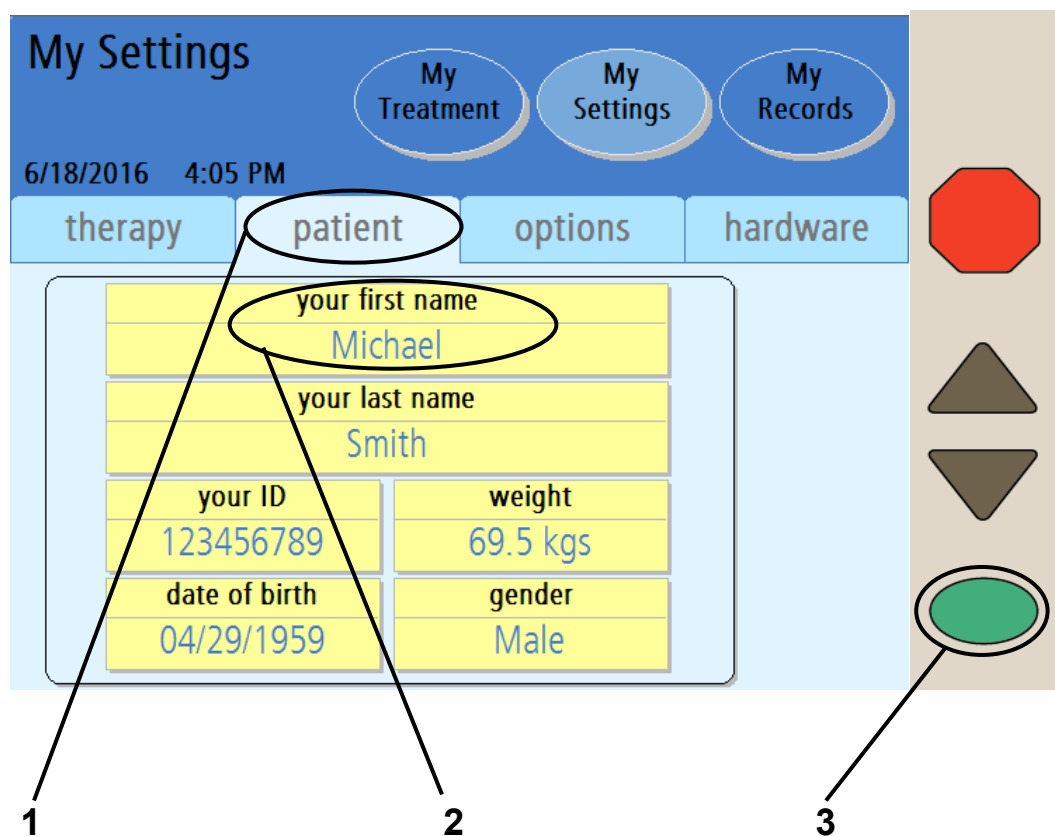

Note: The values shown here are for example only. You must use the values prescribed by your doctor or practitioner.

1 Touch **patient**

Touch the **patient** button to go to the “My Settings: Your First Name” screen.

2 Touch **your first name**

3 Press **OK**

Touch the **your first name** button and then press the **OK** key to enter your first name. You will automatically move to the keyboard screen.



Note: You only need to enter your personal patient information the first time you start up your machine. Your information will be saved for later treatments.

4 Enter your first name

Use the keypad displayed on the screen to enter your name by touching each corresponding letter. The name is displayed in the “Your First Name” box as you type.



Note: Delete the default name before entering your own name. To delete a letter, touch the **Del** button. To switch between upper and lowercase letters, touch the **Cap** button. To exit this screen without making any changes, touch the **Cancel** button and then press the **OK** key.



Note: If you need to enter a number or symbol, touch the ⇨ button on the right side of the text box above the keypad. To return to the letters, touch the ⇐ button that appears on the left side of the text box above the number keypad.

5 Touch **Save**

When you have entered your first name, touch the **Save** button.

6 Press **OK**

Press the **OK** key to confirm and save your settings. You will return to the “My Settings: Patient Settings” screen.

Follow the previous example and touch the **your last name** and **your ID** buttons on the “My Settings: Patient Settings” screen. Your ID number is assigned by your PD nurse. See the “My Treatment Settings” sheet on page 2 for your ID number.

Entering Your Date of Birth

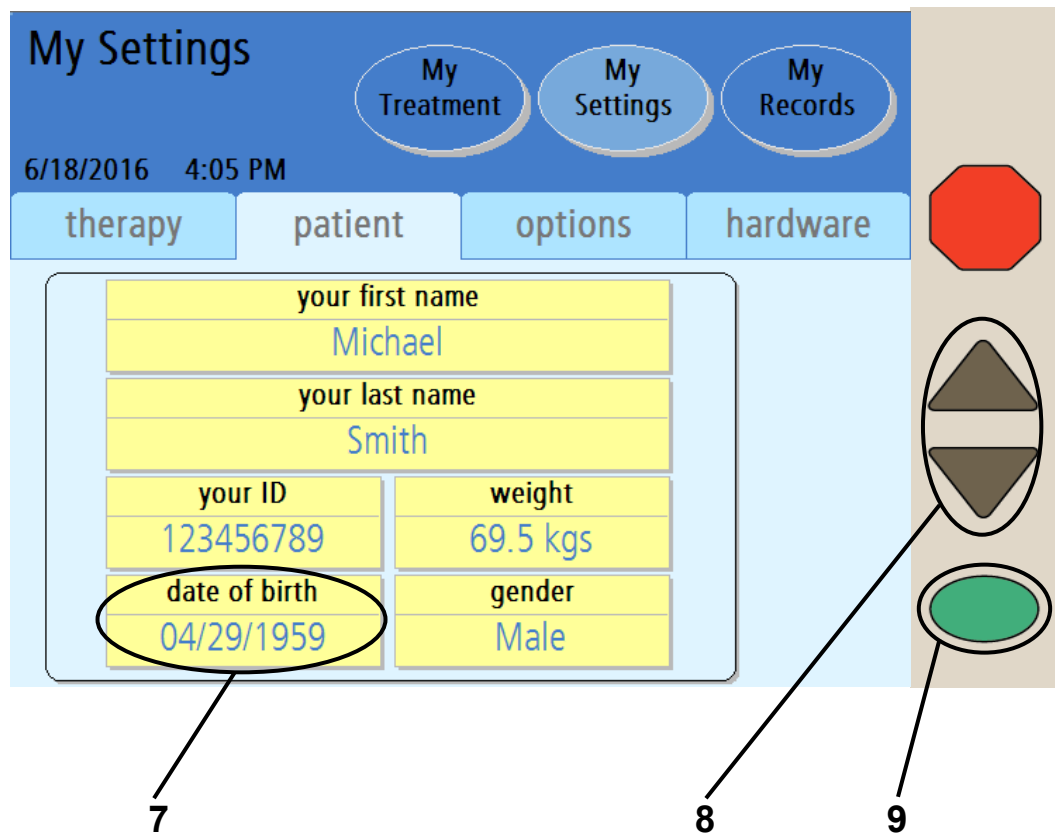

i Note: The values shown here are for example only. You must use the values prescribed by your doctor or practitioner.

7 Touch **date of birth**

Touch the **date of birth** button to enter your birth date. The button will turn orange and the first set of numbers will be active.



Note: Depending on your Date Format setting, you may need to enter the day before the month; see the Date Format button in the “Hardware” section on page 94.

8 Enter your date of birth

Use the **Up/Down Arrow** (▼/▲) keys to change the first two numbers to the month of your birth date. Example:

date of birth
04/29/1959



use arrow keys to set

date of birth
05/29/1959

Press the **OK** key to confirm the selection and move on to the next set of numbers in your birthdate.

date of birth
05/29/1959



use arrow keys to set

date of birth
05/30/1959

Press the **OK** key to confirm the selection and move on to set your birth year as shown above.

9 Press **OK**

When you are finished entering your birth year, press the **OK** key to confirm and save your date of birth. Continue on to the next page to enter your weight.

Entering Your Weight

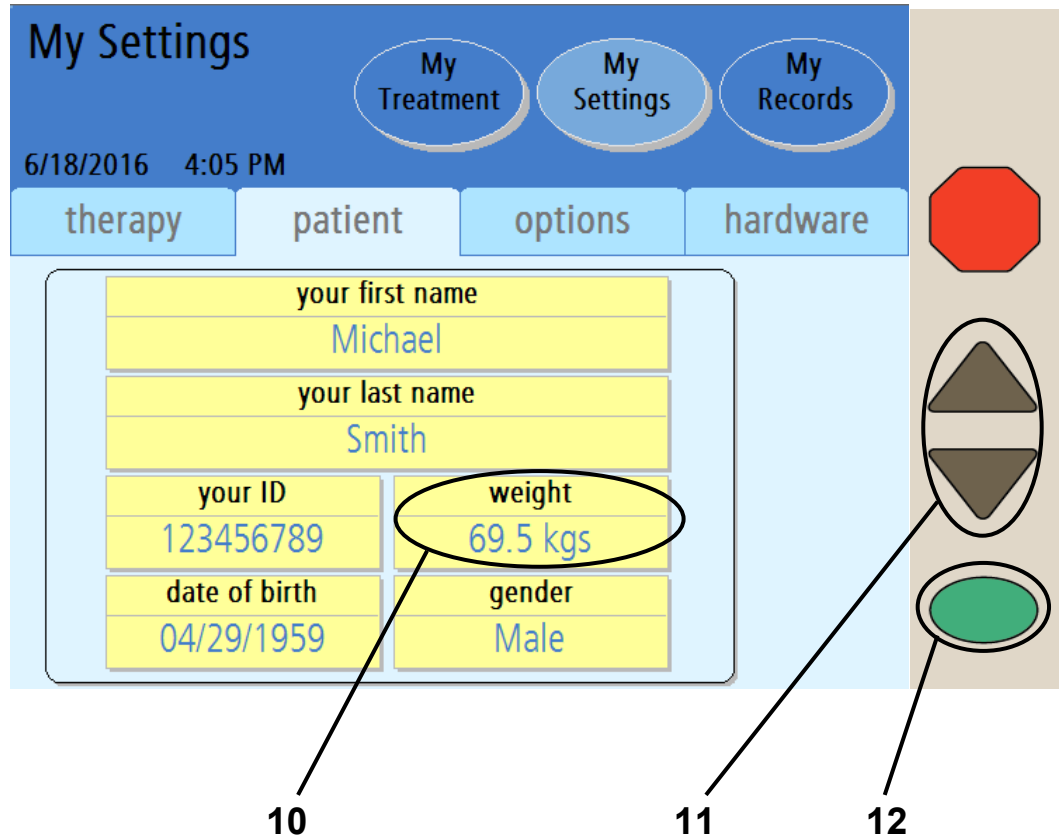

i **Note:** The values shown here are for example only. You must use the values prescribed by your doctor or practitioner.

10 Touch **weight**

Touch the weight button to enter your dry weight as prescribed by your doctor or practitioner.



Note: The weight entered should be your estimated dry weight or target weight as prescribed by your doctor or practitioner; see “My Treatment Settings,” page 6. Failure to enter your own prescribed treatment settings could result in complications that may be severe.



Note: Your weight may be entered in either pounds (lbs.) or kilograms (kg). See “Options Settings,” on page 86.

11 Enter your weight

Use the **Up/Down Arrow** (▼/▲) keys to enter your weight.

12 Press **OK**

When you are finished entering your weight, press the **OK** key to confirm and save your selection. Continue on to the next page to enter your gender.

Entering Your Gender

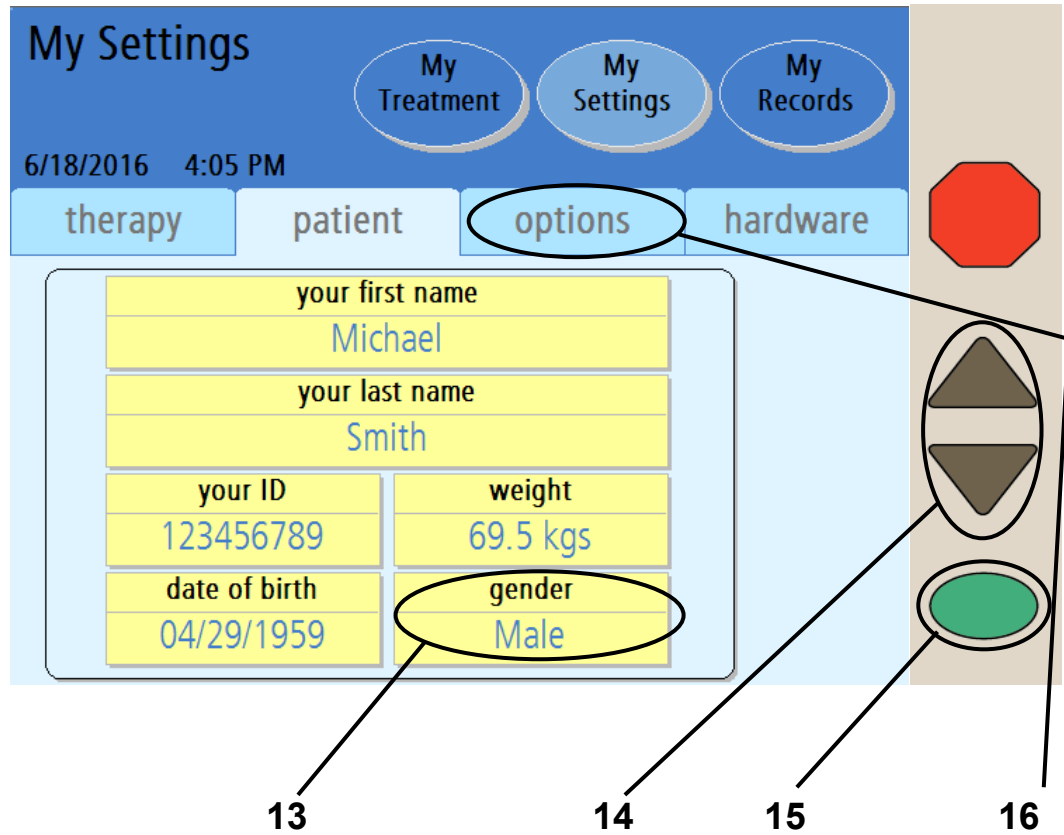

 **Note:** The values shown here are for example only. You must use the values prescribed by your doctor or practitioner.

13 Touch **gender**

Touch the **gender** button to enter your gender.

14 Enter your gender

Use the **Up/Down Arrow (▼/▲)** keys to switch between Male and Female.

15 Press **OK**

When you are finished entering your gender, press the **OK** key to confirm and save your selection.

16 Touch **options**

Touch the **options** button to go to the “Options Settings” screen.

Options Settings Tab

My Settings

6/6/2019 2:43 PM

My Treatment My Settings My Records

therapy patient options hardware

add diurnal UF	last bag option	drain exit %
NO	YES	85%
language	SI units	personal data
EN	YES	NO
USB enabled	add. drain	add. drain alert
YES	YES	YES
flow alert	flow alert sound	
YES	YES	

1 2 3 4



Note: The values shown here are for example only. You must use the values prescribed by your doctor or practitioner.

1 Select values

Touch the yellow button to select the value it displays:

- **Add diurnal UF**—Whether or not to include Drain 0 in the total ultrafiltration (UF) during the day. If you answer YES, the UF from Drain 0 is included in the UF total. This option defaults to NO.
- **Language**—English, Spanish, or French.
- **Last bag option**—If this option is selected, your cyclor will fill you exclusively from the Last Bag line (green clamp) for your Last Fill. During the last dwell your cyclor will empty the heater bag, fill it from the last bag, warm the fluid and deliver this specific solution for your last fill. This option defaults to NO.

If you need more than 24,000 mL total fill volume and do not require a Last Bag Option, this Last Bag line (green clamp) may be used for additional solution.

- **SI Units**—If set to NO, your weight is displayed in lbs., your temperature is in °F, and your blood glucose is in mg/dL.

If set to YES, your weight is in kgs, your temperature is in °C, and your blood glucose is in mmol/dL.

- **Personal data**—If this option is set to YES (recommended), your cyclor will ask you to enter your personal health data on the Personal Data screen after each treatment is complete.
- **USB enabled**— The IQdrive is a device used to transfer your prescription and treatment data. The ‘USB enabled’ option must be set to YES to access data. This option defaults to NO.



Note: The description of the options on this screen is continued on the next five pages.

2 Enter values

When you touch a yellow button, it will turn orange. Use the Up/Down Arrow (▼/▲) keys to set it to your prescribed value. Repeat these steps to enter all of your prescribed values.

3 Press 

Press the OK key to confirm and save your settings.

4 Touch 

Touch the hardware button to go to the “Hardware Settings” screen.

This Page is Intentionally Blank

Options Settings Tab (continued)

My Settings

6/6/2019 2:43 PM

My Treatment My Settings My Records

therapy patient options hardware

add diurnal UF	last bag option	drain exit %
NO	YES	85%
language	SI units	personal data
EN	YES	NO
USB enabled	add. drain	add. drain alert
YES	YES	YES
flow alert	flow alert sound	
YES	YES	

1 2 3 4

i **Note:** The values shown here are for example only. You must use the values prescribed by your doctor or practitioner.

1 Select values

Touch the yellow button to select the value it displays:

- **drain exit %**— If this option is set to 70%, the cyclor will not allow you to complete a Drain until you have drained at least 70% of the drain volume. This is the default setting.

If this option is set to 85%, the cyclor will not allow you to complete a Drain until you have drained at least 85% of the drain volume. Follow your prescription and your PD nurse's instructions.

- **add. drain (additional drain)**—If this option is set to YES, you can perform an additional (planned) drain after completing the last drain. The cyclor will prompt you to choose whether or not to do an additional drain (see Page 150 for more information).

If this option is set to NO, the treatment will continue normally. This option defaults to NO. Follow your PD nurse's instructions.

- **add. drain alert (additional drain alert)**—If this option is set to YES, your cyclor will alert you with an alarm sound to choose whether or not to do an additional drain.

If this option is set to NO, the cyclor will prompt you to choose whether or not to do an additional drain, but without an alarm sound.

- **flow alert and flow alert sound**—The flow alert is a series of self-resetting notification alerts in the form of four soft beeps and an on-screen notification message. It can occur during Drain and Fill phases. This notification sounds if you are not draining or filling as expected.

The flow alert allows you to correct drain or fill issues caused by a kink in the line, or by your body position, without having to interact with the cyclor. Once the flow restarts, the alert will stop.



Note: The sound level or volume of the flow alert is not adjustable but depends on the 'alarm loudness' setting. These sounds are a series of gentle beeps with the first alert at 25 % of the programmed alarm loudness, the next is 50%, and the last is 75%. Each series of beeps occur about one minute apart as long as the cyclor detects slow or no flow.

- If both flow alert and flow alert sound are set to YES (default setting):
 - The flow alert “Notice: Draining slowly” or “Notice: Filling slowly” displays on the cyclor screen
 - The flow alert sound plays once a minute for a total of three times or until the flow resumes.
 - If flow does not resume after the third alert, an alarm will occur
- If flow alert is set to YES and flow alert sound is set to NO:
 - The flow alert “Notice: Draining slowly” or “Notice: Filling slowly” displays on the cyclor screen
 - The flow alert sound will NOT occur
 - If flow does not resume after the third alert message, an alarm will occur
- If both flow alert and flow alert sound are set to NO:
 - The flow alert message will NOT display
 - The flow alert sound will NOT occur
 - The cyclor displays an alarm when you are draining or filling slowly

The alarm that displays depends on whether you are draining or filling. If you continue to drain slowly, a ‘drain complication’ alarm will display. If you continue to fill slowly, a ‘patient line blocked’ alarm will display.

Flow alert and flow alert sound both default to YES. Follow your PD nurse’s instructions on which setting is appropriate for you.

2 Enter values

When you touch a yellow button, it will turn orange. Use the Up/Down Arrow (▼/▲) keys to set it to your prescribed value. Repeat these steps to enter all of your prescribed values.

3 Press

Press the OK key to confirm and save your settings.

4 Touch

Touch the **hardware** button to go to the “Hardware Settings” screen.

This Page is Intentionally Blank

Hardware Settings Tab

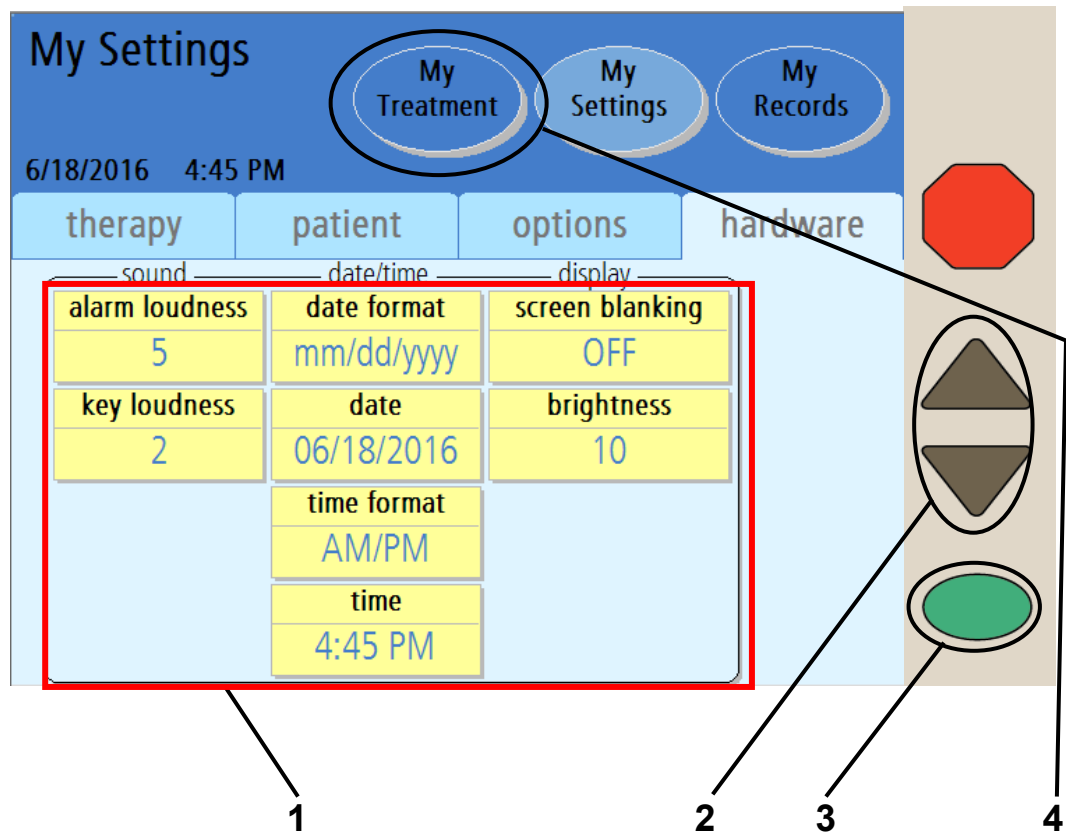

1 Select values

Touch the yellow button to select the value it displays:

- **Alarm loudness**—The volume level of the alarm (1 = soft, 20 = loud)
- **Key loudness**—How loud the key-press sound is (0 = off, 20 = loud)
- **Date Format**—Choose between listing the day before the month or the month before the day
- **Date**—Set today's calendar date (see page 81 for example)
- **Time format**—Choose between 12-hour (AM/PM) or 24-hour time
- **Time**—Set the time
- **Screen blanking**—If this option is set to ON, your Touch Screen will go dark after ten minutes of inactivity. If screen blanking is set to OFF, your screen will always stay on. If you wake up and your screen is dark, you can touch anywhere on the screen and it will light up.
- **Brightness**—How bright the screen is (1 = dark, 10 = bright)

2 Enter values

When you touch a yellow button, it will turn orange. Use the **Up/Down Arrow** (▼/▲) keys to set it to the desired value. Repeat these steps to enter all of your values.

3 Press

Press the **OK** key to confirm and save your settings.

4 Touch

At this point, you should have entered your entire prescription and preferred options. When you are ready to begin your treatment, touch the **My Treatment** screen-button.



Warning: Do not begin your treatment if your settings are incorrect. Improper treatment settings could result in complications that may be severe.

If you are not yet ready to start your treatment, you may leave your machine on this screen. The screen will blank-out after ten minutes if screen blanking is set to YES.

Touch anywhere on the screen to restore the display, when desired.

This Page is Intentionally Blank

My Treatment

Pre-Treatment Checklist

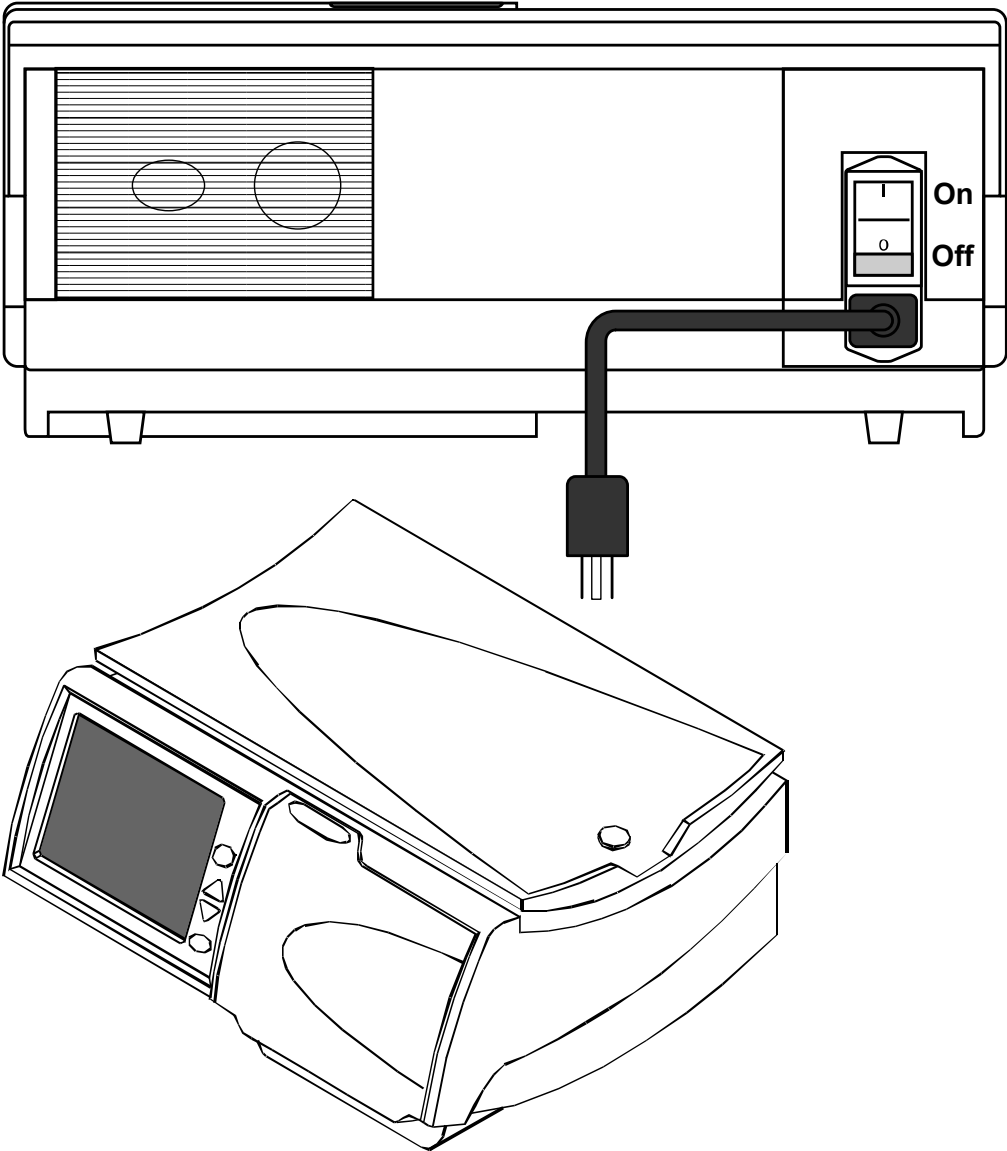

Getting Started

Before you start your treatment, you should check the following on your cyclor:

- Check that the power cord is plugged into a grounded, three-prong electrical outlet, and the power switch on the back of your machine is in the **ON** (|) position.

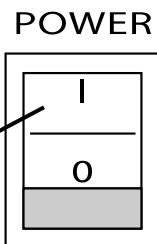

- Check that your machine has been recently cleaned and is ready for treatment (see page 248 for more information).



Warning: If any of the conditions listed above have not been met, you must correct them before continuing with your treatment preparation. Failure to do so could result in complications that may be severe.



Note: Check that, if you are using an IQdrive, the IQdrive is inserted properly into the IQdrive slot on the back of your machine (see page 194).



Note: Your Liberty Select Cyclor automatically runs a self-test during startup and alerts you if a problem exists. No manual testing of your cyclor is required after installation.

Starting Your Treatment

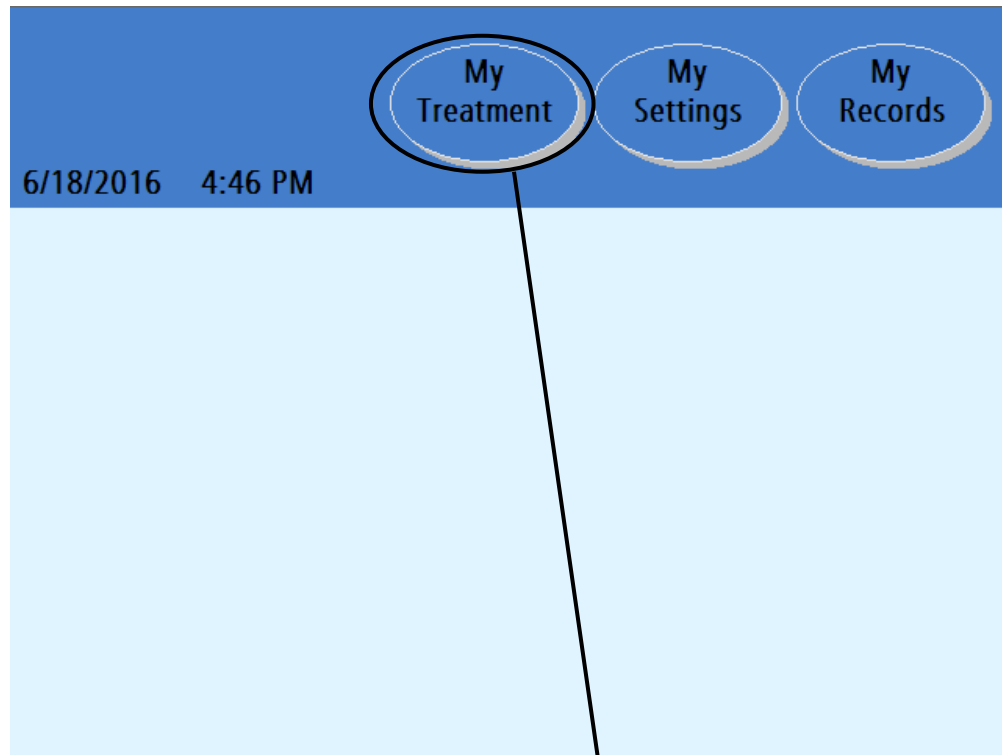

1

1 Touch **My Treatment**

You may reach the “Treatment” screens from any other screen. Touch the **My Treatment** screen-button to begin your treatment setup procedures.

If your cyclor is ON but the screen has blanked-out and is dark, you may touch anywhere on the Touch Screen to restore the display.



Warning: Do not begin your treatment until your entire prescription has been entered.



Warning: Check for proper functioning of your machine before beginning your treatment.



Note: This User’s Guide is only a guide for the Liberty Select Cyclor screens. Follow your exact screen order on the machine and use these pictures only as a reference.



Note: If your IQdrive therapy settings have changed since your last treatment, you will need to review those settings before continuing with your treatment. See “Using the IQdrive,” on page 194. *Do not remove the IQdrive during your treatment.*

Starting Treatment (continued)

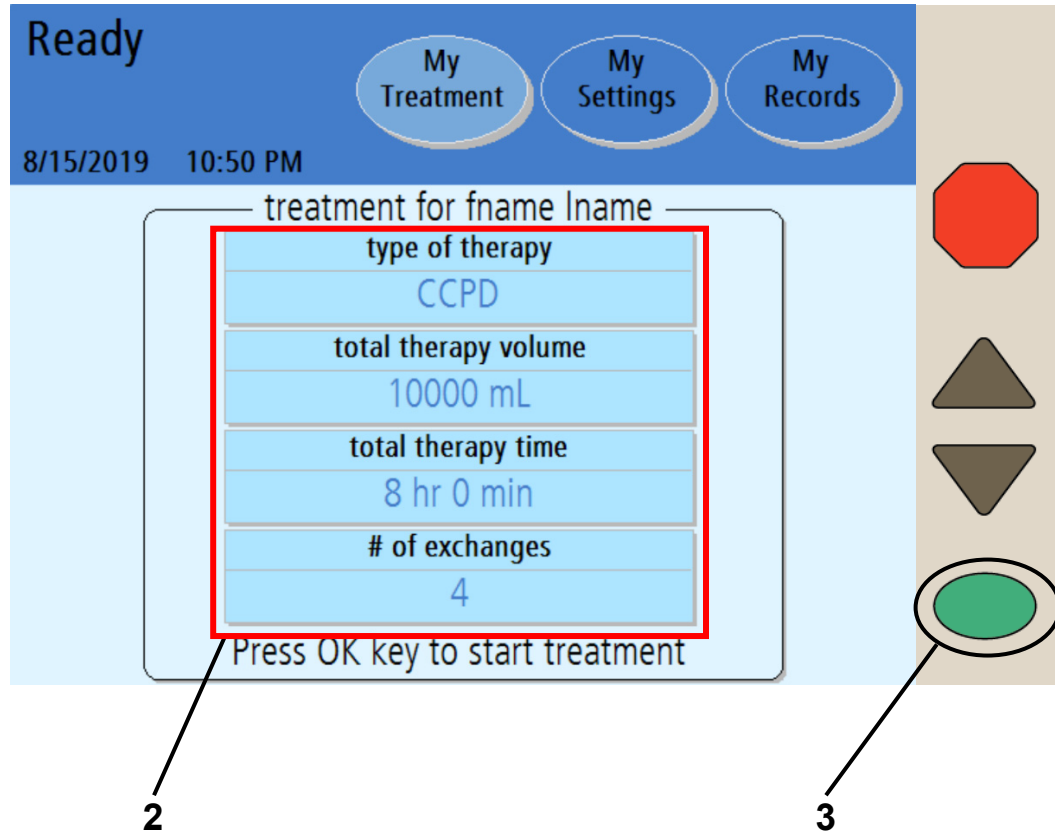

i **Note:** The values shown here are for example only. You must use the values prescribed by your doctor or practitioner.

2 Verify treatment values

The treatment settings displayed on the “Ready” screen must match your prescription (see page 6). If you still need to enter the correct values, turn to page 52.

3 Press

If the treatment values are listed correctly, press the **OK** key to continue. Your cyclor will take a moment to process and you will move on to the next screen.



Warning: Your doctor or practitioner will prescribe your entire treatment. Using incorrect values could result in complications that may be severe. Do not use example values shown in machine pictures.

Preparing

Set-Up

6/18/2016 4:48 PM

My Treatment My Settings My Records

step 1

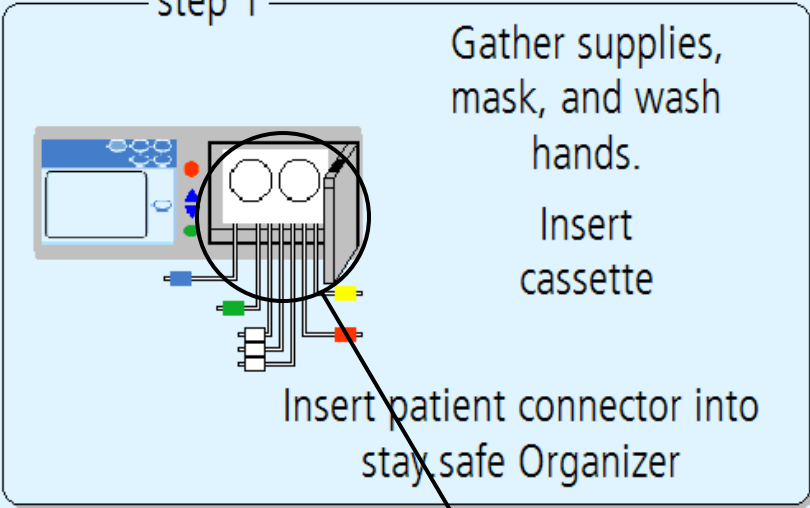

Gather supplies, mask, and wash hands.
Insert cassette

Insert patient connector into stay safe Organizer

The diagram shows a top-down view of the device's cassette area. A circular magnification highlights the cassette and the patient connector. A line connects this magnified area to the number '5' below the diagram.

4 Gather Supplies

5

4 Gather supplies, mask, and wash hands

Before starting your treatment, you will need to get the following ready:

- **Supplies**—Typical supplies are:
 - ✓ Mask
 - ✓ Solution bags
 - ✓ Liberty Cyclor set
 - ✓ stay•safe caps
 - ✓ Drain line or drain bags
 - ✓ Hand sanitizer
- **Mask**—Put on your mask. Everyone else in the room must also wear a mask.
- **Wash hands**—Wash your hands as instructed by your PD nurse.



Warning: You must use aseptic technique as directed by your PD nurse to prevent infection.

5 Inspect cassette



Warning: A new, sterile cassette and drain line must be used for every treatment. Check that the cassette and tubing are free from kinks or damage, and that it is not past its expiration date. Look for scratches, loose tubing or small hole in the cassette membrane. Damaged tubing or cassettes can lead to leaks, contamination, and infection. **Save your tubing set** for pick up and immediately call Customer Service at 1-800-323-5188. You will be contacted about having the used tubing set picked up. **DO NOT USE THIS SET!** Please notify your PD nurse about this event.



Caution: The cassette door is pressurized. Do not attempt to reopen the cassette door until your machine instructs you to. Do not touch the door sensor when loading the cassette, see page 34.

Set-Up

My Treatment

My Settings

My Records

6/18/2016 4:48 PM

step 1

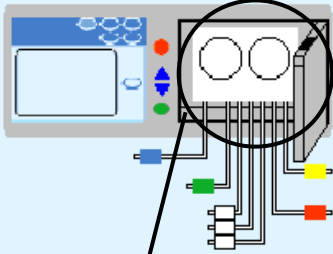

Gather supplies, mask, and wash hands.
Insert cassette

Insert patient connector into stay•safe Organizer

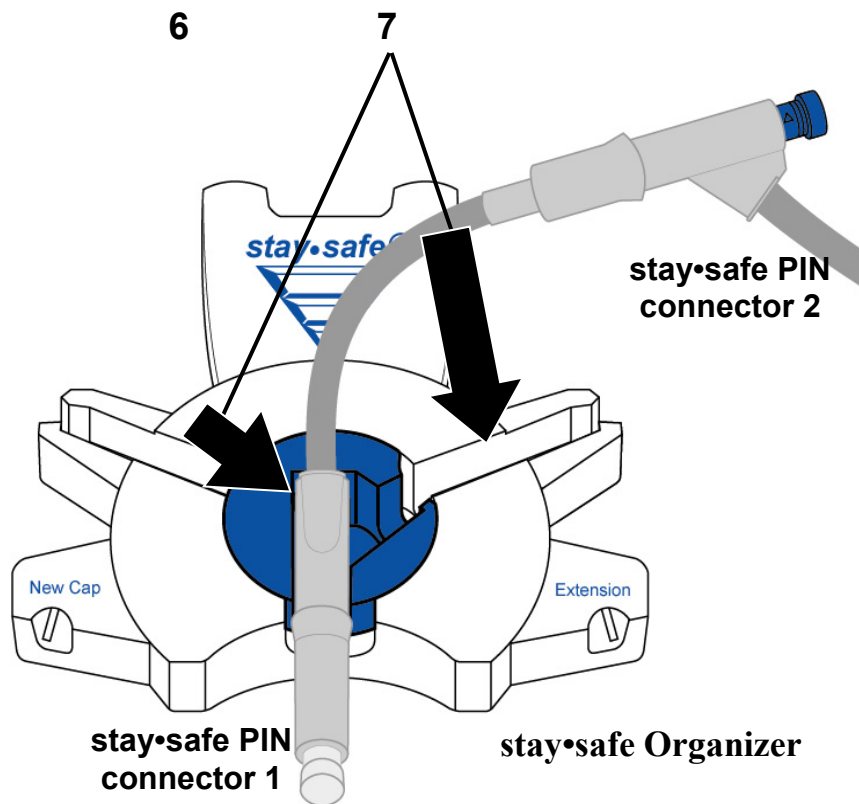

6 Insert cassette



Warning: A damaged cassette can cause peritoneal dialysis (PD) solution to leak into the cyclor and is a potential risk for contamination.

Notify your PD nurse if you find a fluid leak.

To insert the cassette:

- Make sure that the Liberty Select cyclor is positioned near the front of the table or cart so that all lines can hang freely from the cassette.
- Check the package label on the Liberty cyclor set to ensure it is not past its expiration date, and then remove the cyclor set from its packaging. Inspect the cyclor set to make sure it is free from kinks or damage. Look for scratches, loose tubing, or small holes in the cassette film.



Caution: Use caution when touching the cassette film to prevent damage.



Warning: DO NOT USE the set if it is damaged. Put the damaged set aside and immediately call Customer Service at 800-323-5188 to arrange a pick-up to return the damaged set.



Caution: DO NOT insert the cassette until the cyclor prompts you with the on-screen instructions. If you attempt to insert it at any other time, the cassette will not snap properly into place and the door will not close.

- Firmly push the door latch to open the cassette door.



Caution: Avoid touching any of the sensors inside the cassette door, as this could cause damage to the pump module.



Caution: The cassette door is pressurized. Do not attempt to open the cassette door until your machine instructs you to do so.



Warning: Check that the pump module is clean and free from obstructions before inserting the cassette. **Keep fingers clear of moving parts.**

- Hold the cassette with the plastic domes facing outward (towards you).
- To insert the cassette, first slide the cassette up and under the cassette guide pins at the top of both sides of the pump module.
- Next, place your fingers on the cassette and push the cassette into place. Make sure the cassette has snapped into place into the cassette catch at the bottom of the pump module. See “The Pump Module” on page 34 for a drawing of the pump plate.



Note: The cyclor operates the same with or without an alignment bar. The same cassette insertion technique should be used for cyclors with or without an alignment bar.

- If your cyclor *has* an alignment bar, make sure the tubing is hanging down over the alignment bar and in front of the cyclor.
- If your cyclor *does not have* an alignment bar, make sure the tubing is hanging freely down in front of the cyclor.
- Next, look to make sure the cassette has been inserted properly:
 - The cassette should be beneath both guide pins, snapped in place, and resting on the cassette catch.
 - If using a cyclor cart, make sure the tubing is hanging down freely behind the handle.
 - If using a nightstand, make sure the tubing is hanging down freely over the front of the nightstand.

7 Insert stay•safe PIN connector

Next, insert your stay•safe PIN connector into the stay•safe organizer clip below the control panel. Insert the tubing into the Tubing Channel on the right.

Finally, gently close the cassette door. Ensure the cassette door clicks into place to lock it. Your cycler will pressurize the cassette door and then display the next setup screen.



Caution: Do NOT force the door closed. If you are having trouble closing the door, open the cassette door and make sure the cassette has been inserted correctly.

Select Heater Bag

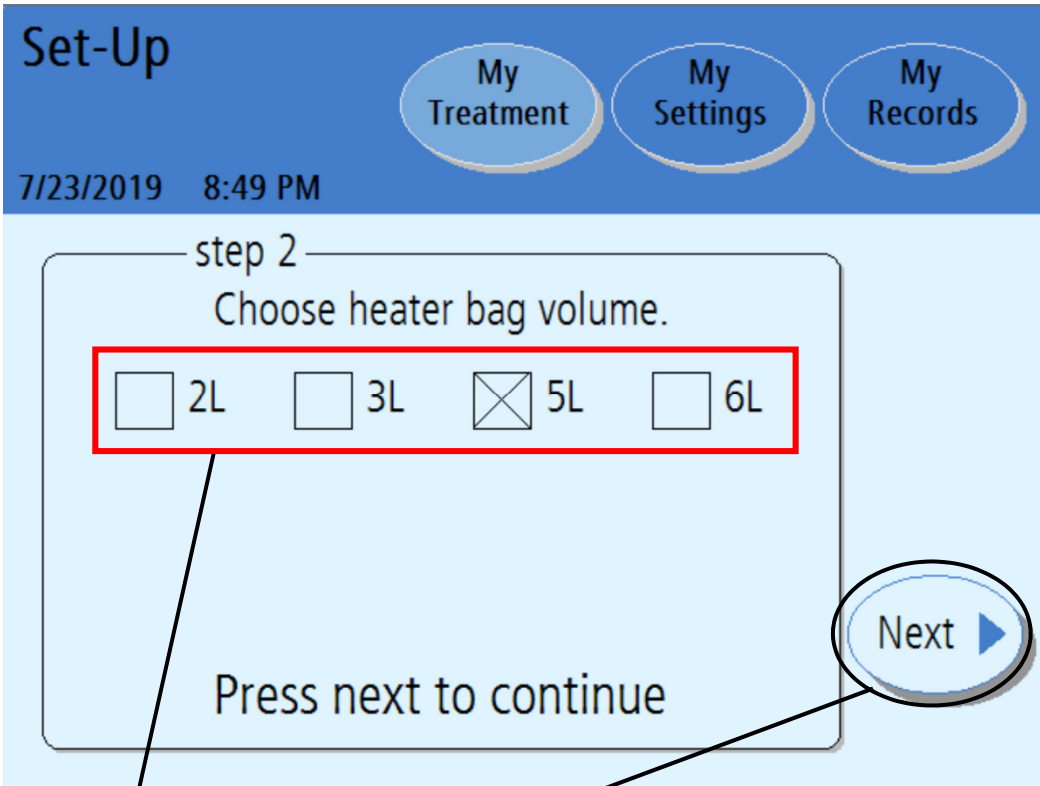

8

9

8 Choose heater bag volume

Select the heater bag volume (2L, 3L, 5L, or 6L) you are using for this treatment. Touch the box beside the volume of the heater bag. This puts an X in the box and saves the heater bag volume for your daily treatments.



Note: The bag you use for your heater bag must be at least 1000 mL larger than your first fill volume and at least as much as your maximum fill volume. Failure to select the correct bag or one that does not have enough volume will result in an alert: “Insufficient fluid in Heater Bag”.

Example: If your prescribed fill volume is 2000 mL plus the extra 1000 mL needed for flushing and priming, the minimum heater bag volume should be at least a 3L bag.

Discuss the proper heater bag size with your PD nurse to help prevent this alert.



Note: Not all solution bag volumes may be available in your area.



Note: Make sure to choose the correct volume for your heater bag. Not enough volume for the prescribed treatment may cause alarms and prevent you from completing a treatment.



Note: Place the solution bag with the largest volume on the heater tray.

Once selected, the cyclor will remember this heater bag volume for future treatments. You will not have to choose again unless your heater bag volume changes.

9 Touch **Next**

Touch the **Next** button to continue. Your cyclor will now prompt you to connect your solution and drain lines, and place your bag on the heater tray.

Connect Solution Lines

Set-Up

5/29/2014 12:19 PM

My Treatment My Settings My Records

step 2

Connect solution lines

Place bag on heater tray

Connect drain line.

Press next to continue

Back

Next

10 11 12 13 14

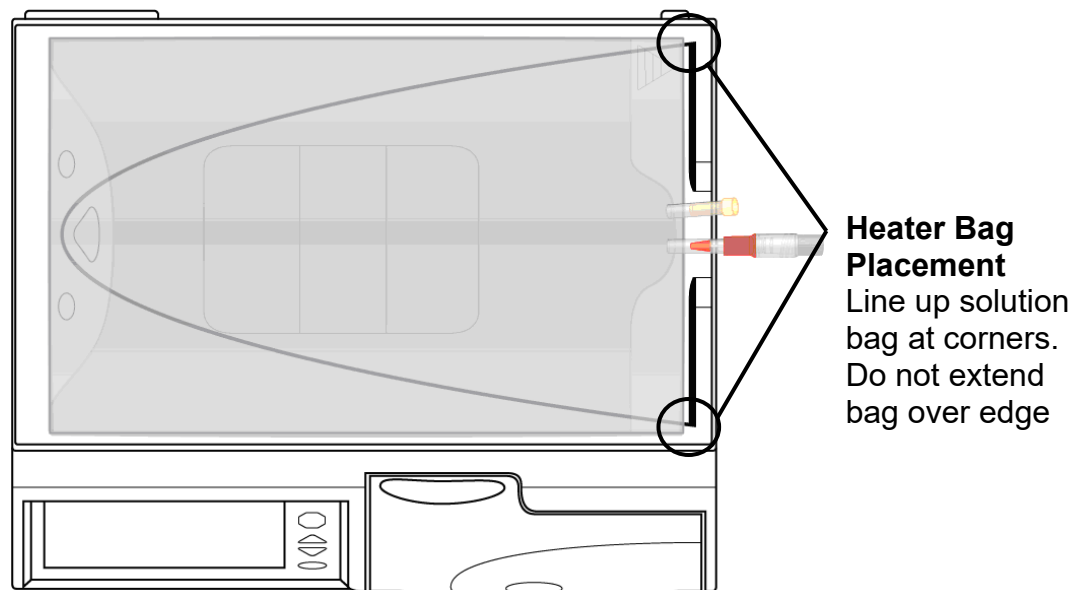



10 Connect solution lines

Check your solution bags for S.C.A.L.E. (solution, clarity, amount, leaks and expiration date). Place your solution bags on a flat surface with the connection ports facing you. **Always use aseptic technique when connecting to solution lines.** Connect the lines as follows:

Connect the heater bag to the line with a  RED clamp.

Connect additional solution bags to lines with a  WHITE clamp.

Connect the last bag to the last bag option with a  GREEN clamp, if required.

Connect the drain line or drain bags to the line with a  YELLOW clamp.



Caution: If you are using the Liberty cart, be sure to properly balance the solution bags by hanging them on both sides of the cart. Unbalanced bags on the cart may cause it to tip over and damage your machine. The maximum load limit on the Liberty cart in addition to the cyclor is 60 lbs. (2.2 lbs. per Liter of solution). Do not overload the Liberty cart. Make sure that you set the cart brakes to OFF when moving the cart and ON when the cart is stationary.



Note: Make sure that the solution bags are placed no more than 3 feet below the cyclor.

11 Place bag on heater tray

The heater bag must be at least 1000 mL more than your first fill volume, but at least 2000 mL. The heater line (red clamp) should already be connected. Once your treatment starts, you must not remove the heater bag. Nothing other than the heater bag may be placed on the heater tray.



Warning: You must properly connect your solution bags as prescribed.



Warning: Do not use external heating sources not authorized by Fresenius Medical Care to warm your solution bags. Contact your PD nurse for more information.



Warning: Make sure that the solution lines are free from kinks.



Warning: Do not allow the heater bag to hang off the heater tray.



Warning: Do not connect any bag when it is hanging on the cart or lying on the floor.

12 Connect drain lines

Connect the cyclor set line with  yellow clamp to a drain line or drain bag set. Do not close the yellow clamp.



Warning: Protective measures **MUST** be taken to prevent backup in the drain line. When connecting the drain line, ensure that an air gap is maintained between the drain line and the drain.



Note: Do not submerge the end of the drain line in liquid such as a toilet bowl. Always remove the cap at the end of the drain line.

13 Touch **Next**

All the prescribed lines should be connected at this point. Touch the **Next** button to continue.

14 Touch **Back**

Press the **Back** button to go back to the previous screen to change the heater bag volume.

This Page is Intentionally Blank

Break Cones and Clamp Unused Lines

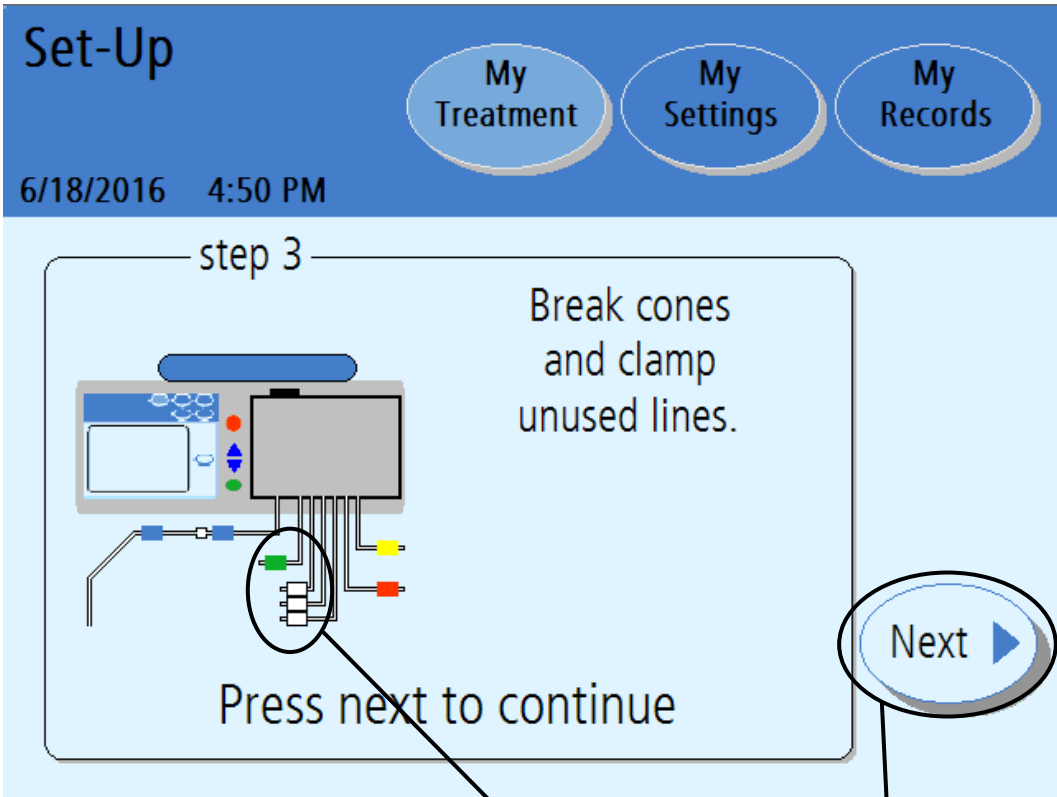

15 Initiate Solution Flow

16

17

15 Initiate solution flow

Obtain the Package Insert that is included in each case of solution bags and follow the specific instructions under "Directions for Use" to initiate solution flow. Make sure the cone is broken completely. A white guide should be visible. You may use Handi-Tool to assist you with breaking the cone.



16 Clamp (close) unused lines

Clamp any line that is not connected to a solution bag. Keep the heater bag line (red clamp), drain line (yellow clamp), and patient line (blue clamp) open throughout setup and treatment.

17 Touch **Next**

Touch the **Next** button to continue. Your cyclor will now test to see which lines are connected.

Check Bags





Set-Up

6/18/2016 4:52 PM

My Treatment My Settings My Records

step 4

Verify bag connections.
Press back to repeat bag detection test.

Last Bag	Bag 3	Bag 2	Bag 1	Heater Bag
				

Press next to continue

Back

Next

18

19

Connected (with unclamped line)

Unconnected (or clamped line)

Note: This picture is an example only. You must follow your prescription and the instructions of your PD nurse.

18 Verify bag connections

During the bag detection test, your machine automatically detects which lines are connected to solution bags and which are not connected to the solution bags. After the bag detection test, your cyclor displays which lines are connected and which are unconnected to solution bags.

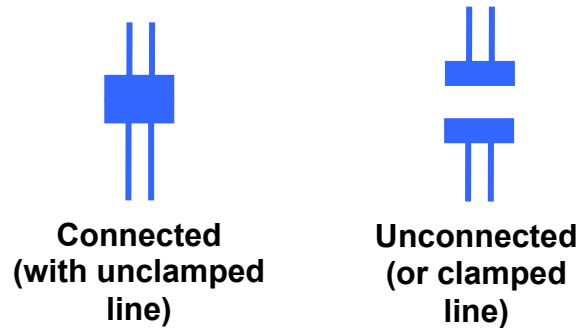

Make sure that your cyclor has properly detected the connected bags and the clamps are open on these lines. The clamps should be closed for unconnected or unused lines. If the bag detection test results are wrong, check the connections, whether the cones are completely broken, and whether the correct clamps are open or closed. Touch the **Back** button to run the bag detection test again.



Note: You must have all of your solution bags connected at this point. After the bag connection verification, you cannot connect another solution bag for your current treatment.

19 Touch **Next**

When each of the connected bags is correctly displayed, touch the **Next** button. Your machine will begin flushing the lines.

Performing Flush

Flushing

6/18/2016 4:53 PM

[My Treatment](#) [My Settings](#) [My Records](#)

Time remaining
1 min 30 sec

Time set
2 min 0 sec

Please wait



Machine Flushing

Your machine will now begin a tubing flush. The screen displays a timer to count down the flushing time.

The next screen will appear when the flushing is complete.



Note: If you need to stop the flushing process, press the **STOP** key. The pump will stop and the “Flushing Stopped” screen will be displayed. Flushing will resume when you press the **OK** key.

Priming

Priming

6/18/2016 4:55 PM

My Treatment My Settings My Records

step 5

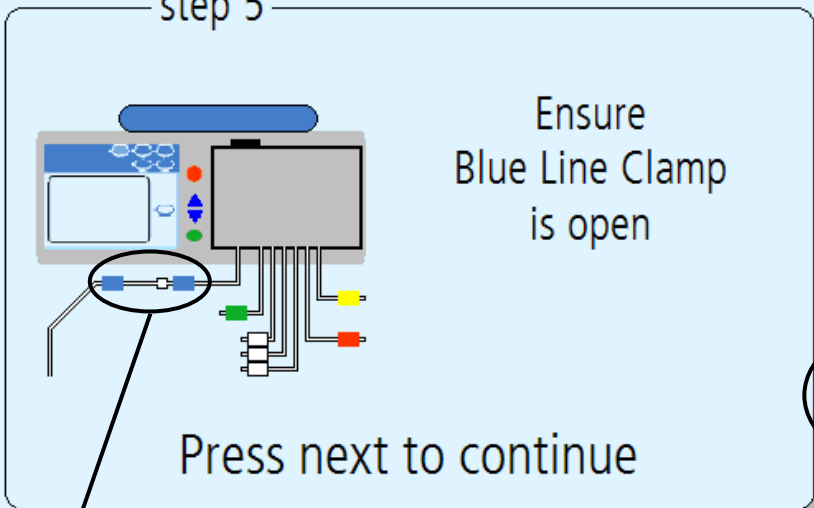

Ensure Blue Line Clamp is open

Press next to continue

Next ▶

20

21

20 Ensure Patient Line (blue clamp) is open

Make sure the patient line (blue clamp) is open to prepare the patient line for priming.

21 Touch **Next**

Touch the **Next** button to begin the priming process.



Note: During the prime phase, the patient line (blue clamp) must be lower than the heater bag.

Performing Prime

Priming

6/18/2016 4:56 PM

[My Treatment](#) [My Settings](#) [My Records](#)

Time remaining
1 min 30 sec

Time set
2 min 0 sec

Please wait



Performing Prime

Your machine will now prime the lines. The screen displays a timer to count down the Priming time.

The next screen will appear when the priming is complete.

Priming Complete

The screenshot shows a user interface for a medical device. At the top, a blue header contains the text "Prime Complete" and the date/time "6/18/2016 4:56 PM". To the right of the header are three circular buttons: "My Treatment", "My Settings", and "My Records". The main content area is light blue and contains a large rounded rectangle labeled "step 6" at the top. Inside this rectangle, there is a callout bubble with the text "Close patient line clamp or press back to prime again". Below the callout, it says "Press next to continue". To the right of the rectangle are two buttons: "Back" with a left-pointing arrow and "Next" with a right-pointing arrow. The "Next" button is circled. Two lines with numbers "22" and "23" point to the callout bubble and the "Next" button, respectively.

Prime Complete
6/18/2016 4:56 PM

My Treatment My Settings My Records

step 6

Close patient line clamp
or
press back to prime again

Press next to continue

Back

Next

22 23

22 Prime Complete

Close patient line (blue clamp) or press back to prime again
If you see air in the lines and need to prime them again, touch the **Back** button. Your machine will re-prime the lines.



Note: If you are using tubing set model P/N 050-87216 with a twenty foot long patient line, you may need to press the **Back** button again to ensure the line is fully primed.

If your lines have been primed and there is no air in them, close the patient line (blue clamp).

23 Touch **Next**

Make sure your patient line (blue clamp) is clamped.
Touch the **Next** button to continue to the next screen. The daytime manual exchange screen will appear. You will need to enter your daytime manual exchange volume, if you performed a manual exchange.

A manual exchange is when you connect your catheter extension set to a bag of solution and perform an exchange without using your Liberty Select Cycler.

Entering a Daytime Exchange

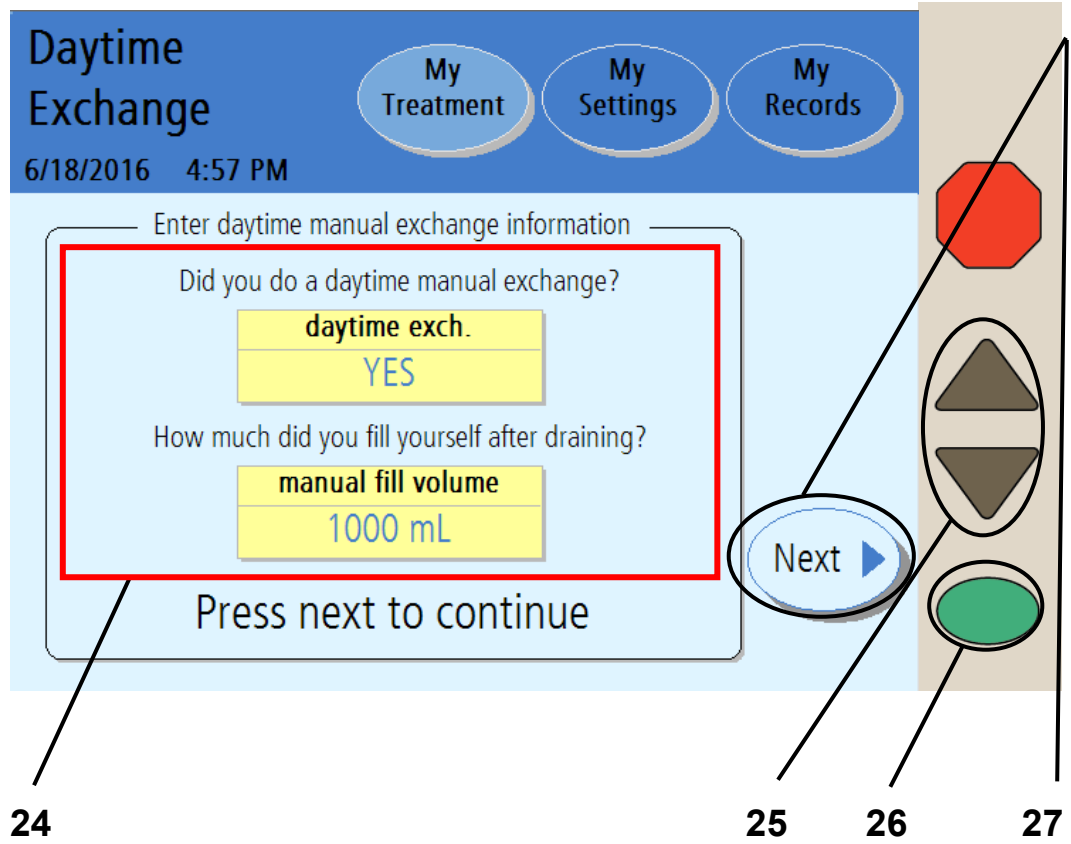

Note: The values shown here are for example only. You must use the values prescribed by your doctor or practitioner.

24 Select daytime manual exchange information

If you did not perform a manual exchange Fill since you last turned off your cyclor, you may leave this button set to NO. Continue to step 26 below.

If you did perform a manual exchange Fill since you last turned off your cyclor, you must set the **daytime exch.** button to YES.



Warning: You must enter whether or not you performed any manual exchanges since you last turned off your cyclor. If you performed a manual exchange, you must then also enter the fill volume. If you do not program this information into your Liberty Select Cyclor at this time, your cyclor will not know that you have additional fluid in your abdomen. Do NOT bypass Drain 0. Your Liberty Select Cyclor will switch to Fill 1 when you are finished draining.

To set the **daytime exch.** button to YES, touch the button and it will turn orange. Use the **Up/Down Arrow (▼/▲)** keys to change it from NO to YES. Press the **OK** key to save the change.

25 Enter manual fill volume if you had a manual exchange

After setting the **daytime exch.** button to YES, the **manual fill volume** button will change from gray to yellow. You may now edit that button. Touch the **manual fill volume** button, it will turn orange. Use the **Up/Down Arrow (▼/▲)** keys to scroll up or down to the fill volume you have left in your abdomen from your last manual exchange Fill.

26 Press **OK**

Press the **OK** key to confirm and save your settings.

27 Touch **Next**

Touch the **Next** button to continue to the next screen.

Confirming Your Daytime Exchange

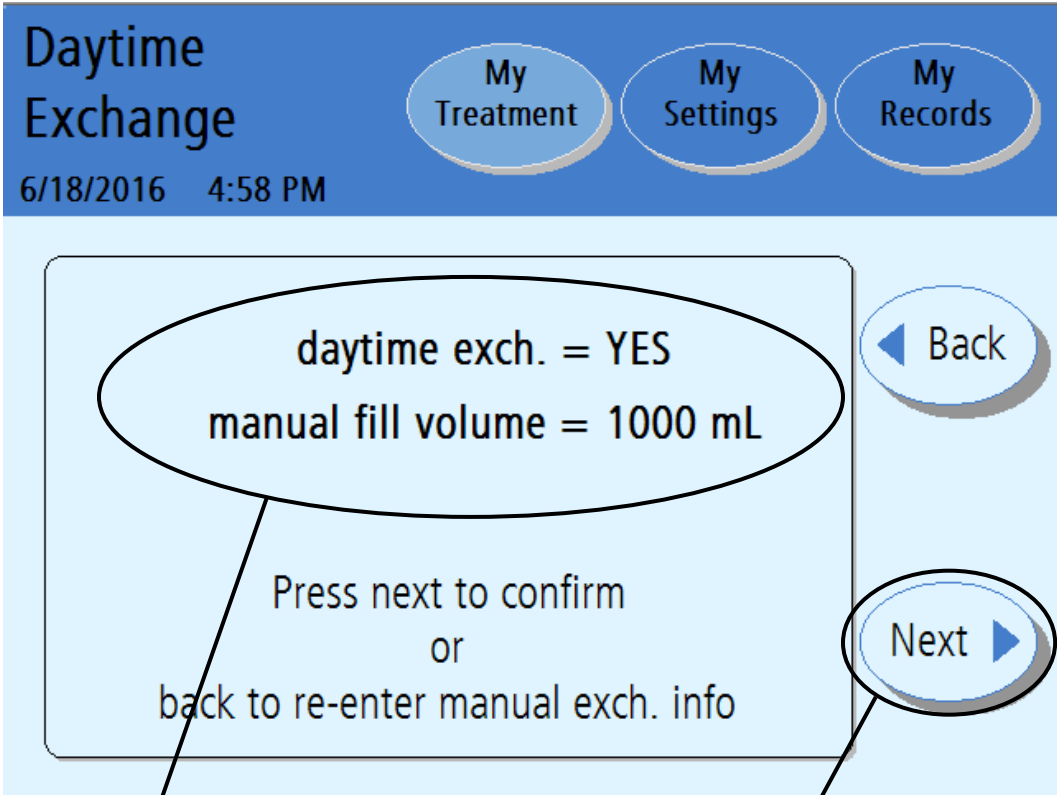

28

29

28 Double-check your daytime exchange values

Your cyclor will display the daytime exchange values you just entered on the previous screen.

If the values are not correct, touch the **Back** button. Then re-enter the correct values (see the previous page).

29 Touch **Next**

If your daytime exchange values are listed correctly, touch the **Next** button to continue to the next screen.

The next screen will provide instructions on how to connect to your machine.

Ready for Treatment - Connecting Yourself

Ready for Treatment

6/18/2016 4:59 PM

My Treatment My Settings My Records

step 7

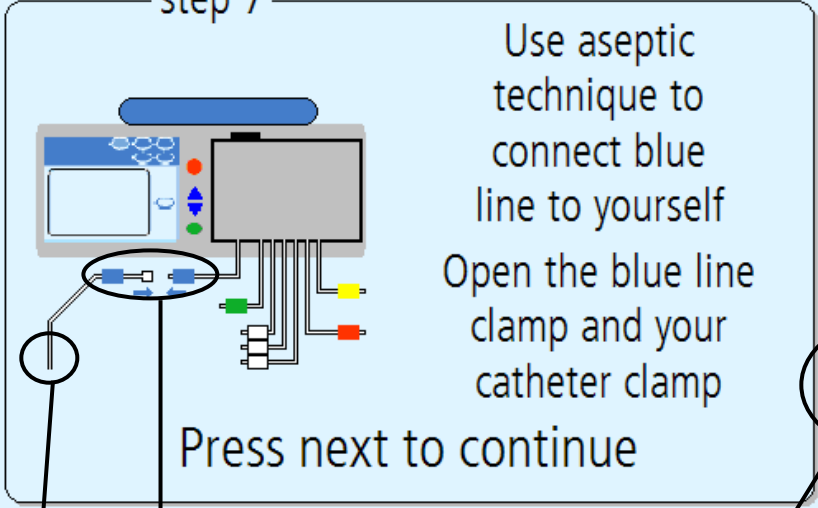

Use aseptic technique to connect blue line to yourself
Open the blue line clamp and your catheter clamp

Press next to continue

Next

30 31 32

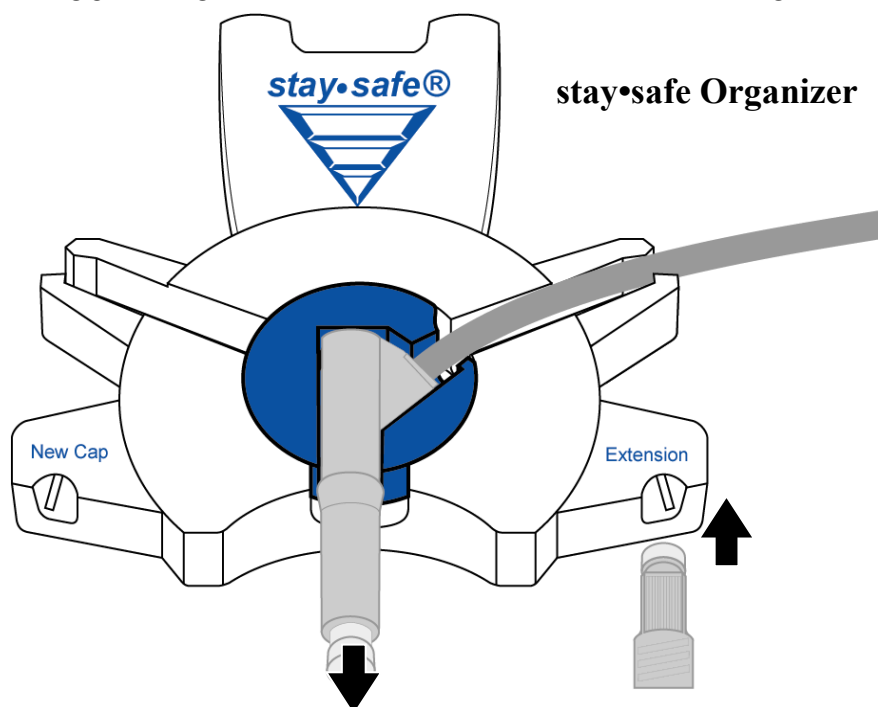

30 Use aseptic technique to connect yourself



Warning: You must use aseptic technique to prevent infection. Keep your mask on until you have finished connecting.



Warning: Use a new, sterile PIN connector each time you connect.

To connect to your cycler:

- Mask, then wash your hands or use hand sanitizer as directed by your PD nurse
- Insert your catheter extension set into the right notch of the stay•safe Organizer to remove the cap
- Remove the clear cap from the stay•safe PIN connector
- Connect your catheter extension set to the stay•safe PIN connector on the patient line (blue clamp)



Note: You may remove the PIN connector from the stay•safe Organizer after your connection is completed to allow more freedom of movement during the treatment.



Note: Be careful not to push in the blue button on the PIN connector until prompted by the cycler (after a treatment or when interrupting/ pause a treatment).

If you push in the blue button before prompted by the cycler, the PIN releases and will prevent fluid from moving through the tubing, which can cause an alarm.

31 Open the patient line (blue clamp) and your catheter extension set clamp

32 Touch **Next**

Press the **Next** button to begin your prescribed exchanges.



Warning: If you turn off your cycler after you have filled the abdomen, when you restart your cycler you **MUST NOT** bypass Drain 0. It could result in an overflow.



Warning: If you do one or more manual daytime exchanges that are not programmed into the Liberty Select Cyclor, your cyclor will not know that you have additional fluid in your abdomen. Do NOT bypass Drain 0. Your Liberty Select Cyclor will switch to Fill 1 when you are finished draining.



Note: Your actual treatment time starts with the beginning of Drain 0.

For information on bypassing an exchange, see page 190.

Exchanges

Exchanges

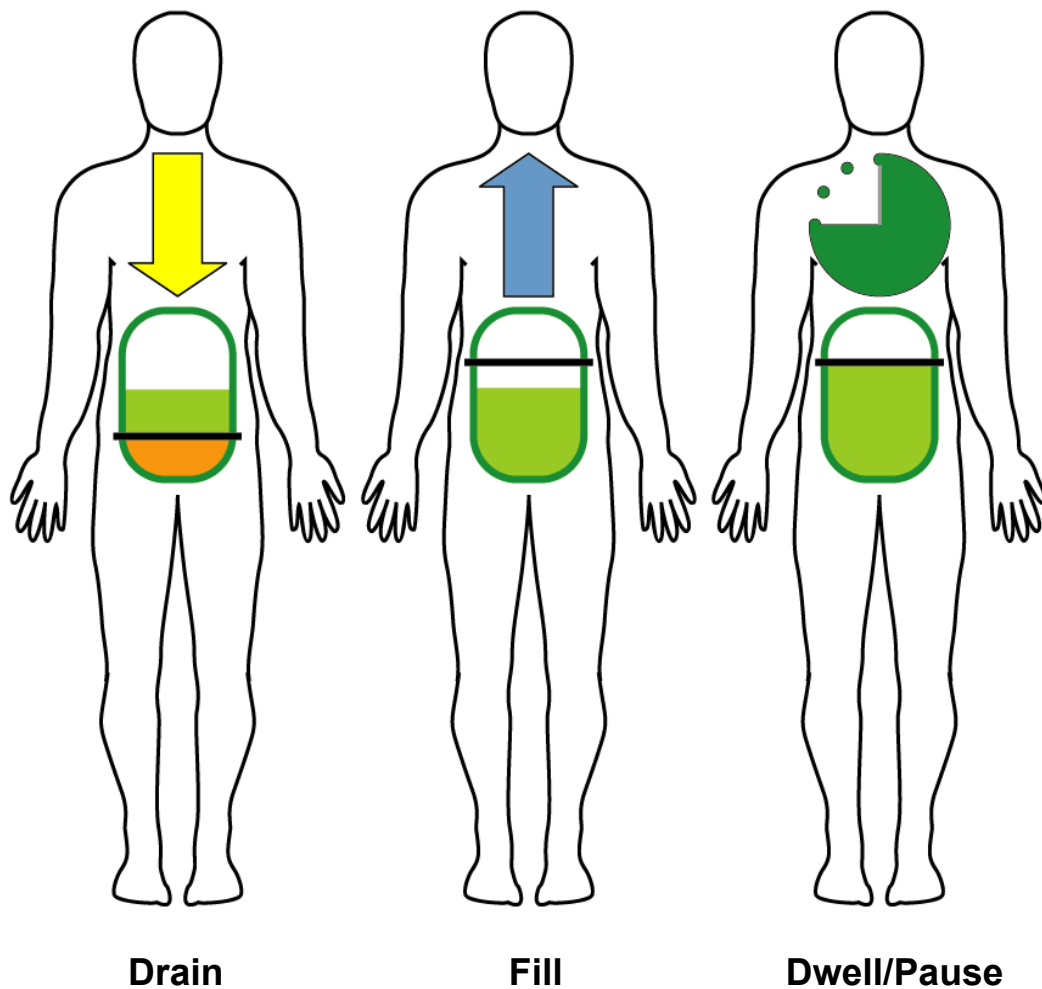

IPD – Intermittent Peritoneal Dialysis

IPD is an *Intermittent Therapy*, meaning it is interrupted. With IPD, your cyclor does your Exchanges during the night. Your machine Drains you in the morning so you do not have dialysate in your peritoneal cavity during the day.

Tidal Peritoneal Dialysis

Depending on the program, Tidal PD can be either Intermittent or Continuous. With Tidal PD, your cyclor does your Exchanges during the night. However, your machine does not always fully drain you during each Exchange. Only a portion is drained and filled with each Exchange. Depending on your prescription, you may end the treatment with a Fill or Drain.

CCPD – Continuous Cycling Peritoneal Dialysis

CCPD is a *Continuous Therapy*. It is the most common therapy prescribed. With CCPD, you have dialysate in your peritoneal cavity at all times. Two or more dialysate Exchanges are done through the night and one long Exchange is done during the day. Each morning your cyclor will fill you for the day. When you reconnect to your machine again at night, you must first drain the dialysate that dwelled in you since the end of your last treatment.

PD+ – Peritoneal Dialysis Plus™

PD Plus™ is a *Continuous Therapy* like CCPD, but it also includes Drains and Pause-type Dwells during the day to offer more waste removal.

Your cyclor's screen order

The number of times that you drain, fill, and dwell (or pause) depends on your prescribed therapy. The following screens are shown only to explain the different features. Follow your own machine's setup. Your cyclor will automatically take you through your prescription.

Exchange: Drain 0

Drain 0 of 5

My Treatment My Settings My Records

6/18/2016 5:00 PM

Ultrafiltration (UF)
500 mL

Expected drain volume
1000 mL

Total volume drained
1500 mL

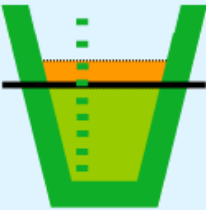

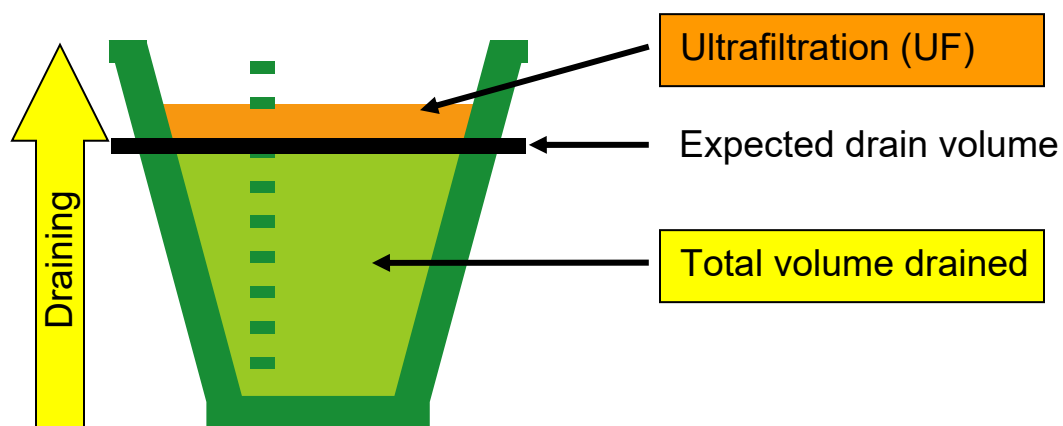

i **Note:** The values shown here are for example only. You must use the values prescribed by your doctor or practitioner.

Drain 0

Drain 0 is the initial Drain that starts your treatment. Drain 0 does not count toward your total ultrafiltration (UF) for the entire treatment unless the ‘Add diurnal UF’ option was set to YES (see page 86).



Warning: Do not bypass Drain 0 unless you have discussed your treatment program with your doctor, practitioner or PD nurse. For information on bypassing an exchange, see page 186.

All Drain screens

The “Drain” screen displays a graph to track your Drain progress. As your cycler drains you, the fluid level in the cup will rise.

You will continue to drain until the fluid level rises to the black line. This black line is your expected drain volume. This is based on your prescription.

Ultrafiltration is the excess fluid that is removed during your drain. The graph will show the fluid level rise past the black line. Any ultrafiltration is shown in orange above the black line on the cup.



Note: If you are a positional drainer you may need to change your body position throughout your treatment. Discuss this further with your PD nurse.



Note: If you need to stop the draining process, press the **STOP** key. The pump will stop and the “Draining Stopped” screen will be displayed. Draining will resume when you press the **OK** key.

When the Drain is complete, your cycler will either begin to fill you with fresh dialysate or end your treatment. If you are ending your exchanges with a Drain and this is the last Drain of your treatment, then turn to “Ending Treatment” on page 154. For Fills, see the Fill explanation on the next page.

Exchange: Fill1



Fill 1 of 5

My Treatment My Settings My Records

6/18/2016 5:02 PM

Volume set
1000 mL

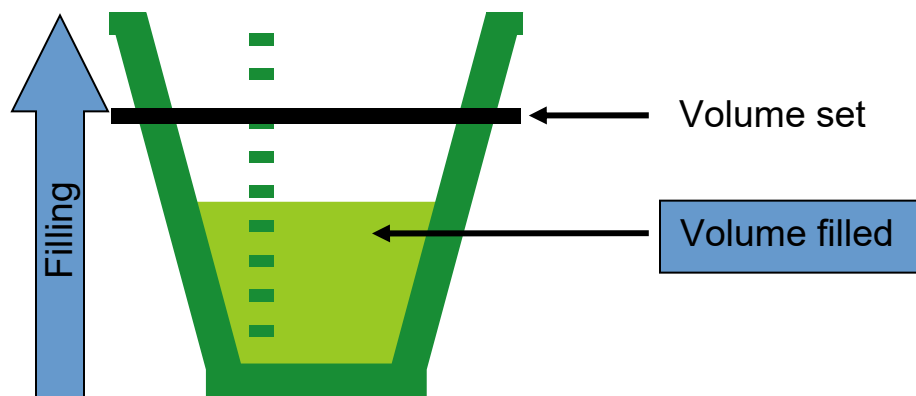
Volume filled
500 mL



i **Note:** The values shown here are for example only. You must use the values prescribed by your doctor or practitioner.

Fill 1

Fill 1 is the First Fill of your treatment. Your cyclor will always go to Fill 1 after Drain 0.

All Fill screens

The “Fill” screen displays a graph to track your Fill progress. As your cyclor fills your abdomen, the fluid level in the cup will rise. The black line indicates the prescribed fill volume level.

You will continue to fill until the graph rises to the black line. This black line indicates your set fill volume. This is based on your prescription.



Warning: If you feel a large, painful build-up of pressure during your fill, do not finish your fill cycle. You must press the **STOP** key to stop your cyclor immediately. You may perform a STAT drain if you have been trained. Always call your PD nurse or doctor or practitioner if you have these symptoms. Overfilling can cause serious injury or death. For more information on overfilling, see page 190.



Note: You may fill more quickly lying down than sitting or standing up. There is less pressure on your abdomen in a lying down position.



Note: If you need to stop the Fill process, press the **STOP** key. The pump will stop and the “Filling Stopped” screen will be displayed. Filling will resume when you press the **OK** key.



Note: Your cyclor will delay your first fill if the solution temperature in the heater bag has not reached 33°C (91.4°F). When the temperature reaches at least 25°C (77°F), your cyclor will display the message “Solution is warming. Press OK key to start fill...” By pressing the **OK** key, the fill will begin with cool solution, which could feel uncomfortable. If this happens, do not press the **OK** key. The heater bag will warm the PD solution before automatically starting the fill.

When the Fill is complete, your cyclor will go to Dwell (page 148) or Pause (page 142) depending on your therapy.

If you programmed a Last Fill, and this is the last Fill of your treatment, go to “Ending Treatment” on page 154.

Exchange: Pause

Pause 1 of 5

My Treatment My Settings My Records

6/18/2016 12:54 PM

Pause time
1 hr 45 min

- Push in the PIN
- Close blue and catheter clamps
- Insert patient connector into stay.safe Organizer
- Aseptically disconnect yourself

Next ▶

Press next to continue

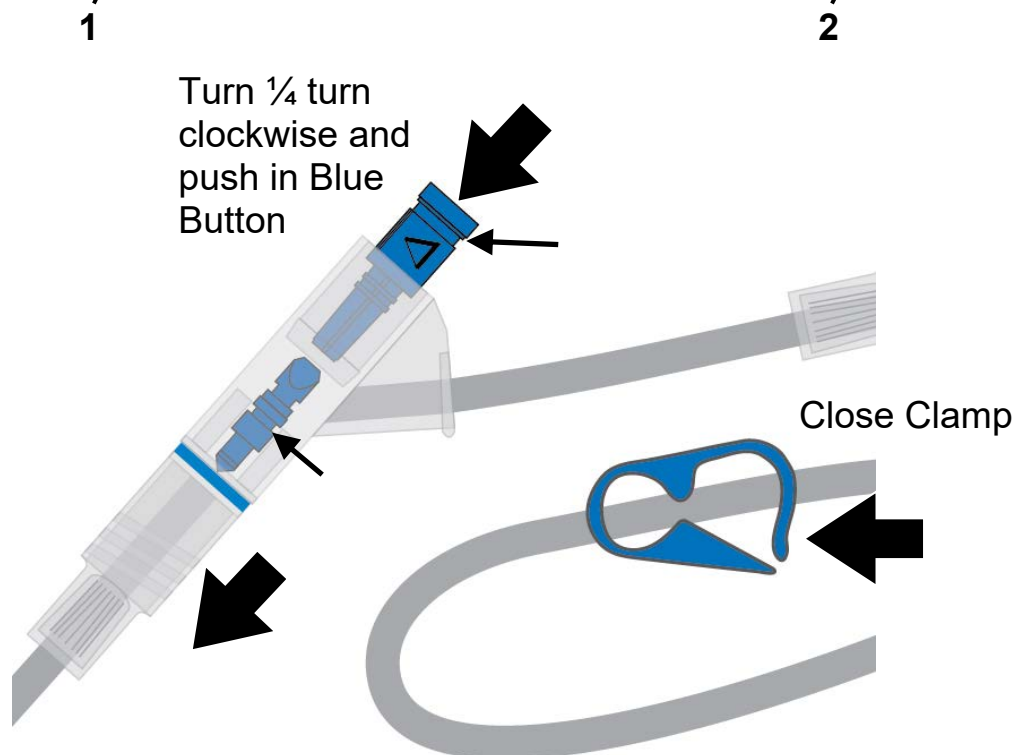

1 Pause: Disconnect from cyclor

A Pause is a special type of Dwell. During a Pause you still dwell with the solution in your abdomen, but you may choose to disconnect from your cyclor. It is also different from other Dwells because it is not timed, meaning you may pause for as long as you need. The number of Pauses during your treatment depends on your prescription; see “My Treatment Settings” on page 6.

When your cyclor is on the “Paused” screen, you may disconnect from your machine.



Warning: You must use aseptic technique as directed by your PD nurse to prevent infection.



Warning: Use a new, sterile stay•safe PIN connector and cap every time you disconnect from your cyclor. Be sure to insert the new, sterile cap into the stay•safe New Cap Holder before you disconnect.

To disconnect from your cyclor:

- Mask, then wash or sanitize hands as instructed by your PD nurse.
- Insert the stay•safe PIN connector connected to your catheter extension set into the stay•safe organizer clip below the control panel
- Insert a new stay•safe cap on the left side of the organizer
- Turn the blue button on the PIN connector $\frac{1}{4}$ turn clockwise and push it in to make sure that the PIN has been inserted into the PIN connector
- Close patient line (blue clamp)
- Close catheter extension set clamp
- Use aseptic technique to carefully disconnect your catheter extension set from your patient line and cap off with a new sterile stay•safe cap
- Check that the new sterile stay•safe cap is securely attached to your catheter extension set before removing it from the stay•safe organizer

Your cyclor will display how long you pause under ‘Pause time’.

2 Touch **Next**

You may now leave your machine. Touch the **Next** button when you are ready to reconnect to your cyclor.



Note: The **Next** button is not available until your cyclor has finished filling up the heater bag.

This Page is Intentionally Blank

Exchange: Pause Re-Start

Pause 1 of 2
Re-Start

6/18/2016 5:04 PM

My Treatment

My Settings

My Records

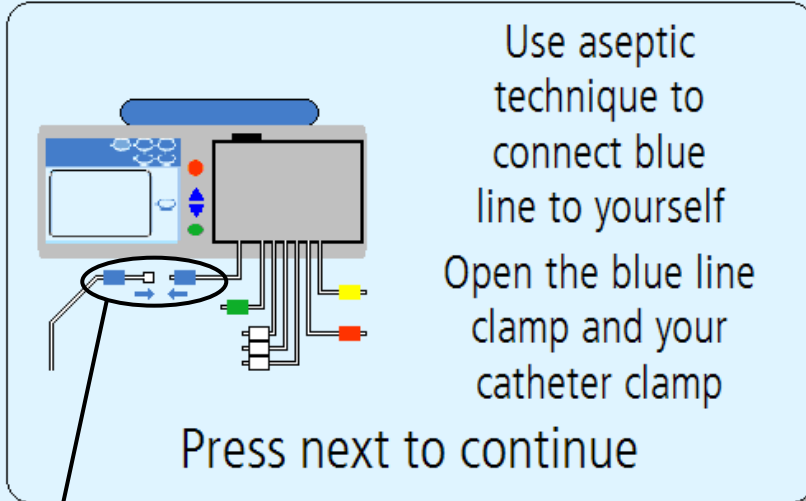

Use aseptic technique to connect blue line to yourself
Open the blue line clamp and your catheter clamp

Press next to continue

Next

3

4

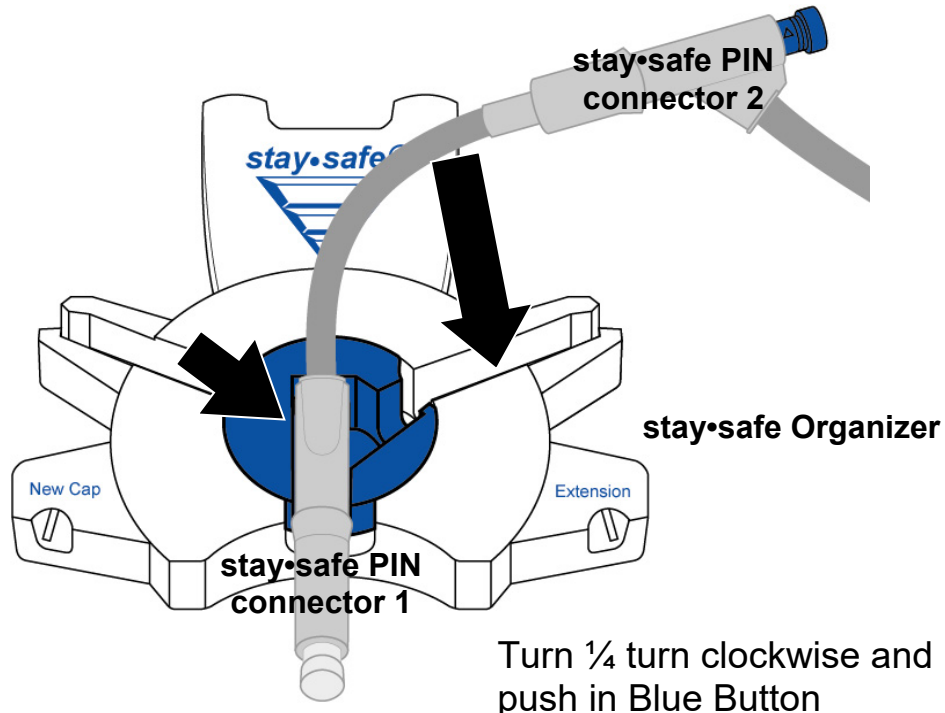

stay•safe PIN connector 2

stay•safe Organizer

New Cap

Extension

stay•safe PIN connector 1

Turn ¼ turn clockwise and push in Blue Button

3 Reconnect to your cyclor

Reconnect to your machine when you are ready to resume your treatment. Be sure to remove your **used** stay•safe PIN connector from its holder before beginning.



Warning: You must use aseptic technique as directed by your PD nurse to prevent infection. Wear a mask and wash your hands before reconnecting.



Warning: Reconnecting to a used PIN connector may increase the risk of infection.

You can only reconnect to your cyclor and perform a Pause or unplanned disconnection when using a cyclor set with dual PIN connector or an MTS (Multiple Tubing Segment) set.

To reconnect to your cyclor:

- Put on your mask
- Wash your hands
- Unwrap the next stay•safe PIN connector
- Insert the next stay•safe PIN connector on your patient line into the stay•safe organizer clip below the control panel
- Insert the tubing into the Tubing Channel on the right
- Remove the clear stay•safe cap from the stay•safe PIN connector
- Connect your catheter extension set to the stay•safe PIN connector on the patient line (blue clamp)
- Open patient line (blue clamp)
- Open catheter extension clamp

4 Touch **Next**

When you touch the **Next** button, your machine will begin the Drain process. Turn to page 138 for more information on the Drain process.

Exchange: Dwell

Dwell 1 of 5

6/18/2016 5:05 PM

My Treatment My Settings My Records

Time remaining
1 hr 45 min

Time set
2 hr 00 min



Note: The values shown here are for example only. You must use the values prescribed by your doctor or practitioner.

All Dwell screens

During a Dwell, you stay connected to your machine while your fluid dwells inside your abdomen. Most Dwells take place at night when you are sleeping.

The “Dwell” screen displays a timer to count down your Dwell time. During Dwell stage, your machine will refill the heater bag. The heater tray will warm the solution for your next Fill.



Warning: During the heating process, the Heater Tray can get as hot as 50 °C (122 °F). Do not come into contact with the Heater Tray as it may cause injury.



Note: If you need to stop the dwell process, press the **STOP** key. The Dwell timer will stop counting down and the “Dwell Stopped” screen will be displayed. The Dwell will resume when you press the **OK** key.



Note: The cyclor cannot bypass an exchange while the heater bag is filling and it does not have enough solution for the next fill.

When your Dwell time is complete, your cyclor will drain you again. See page 138 for more information on the Drain process.

Additional Drain Option

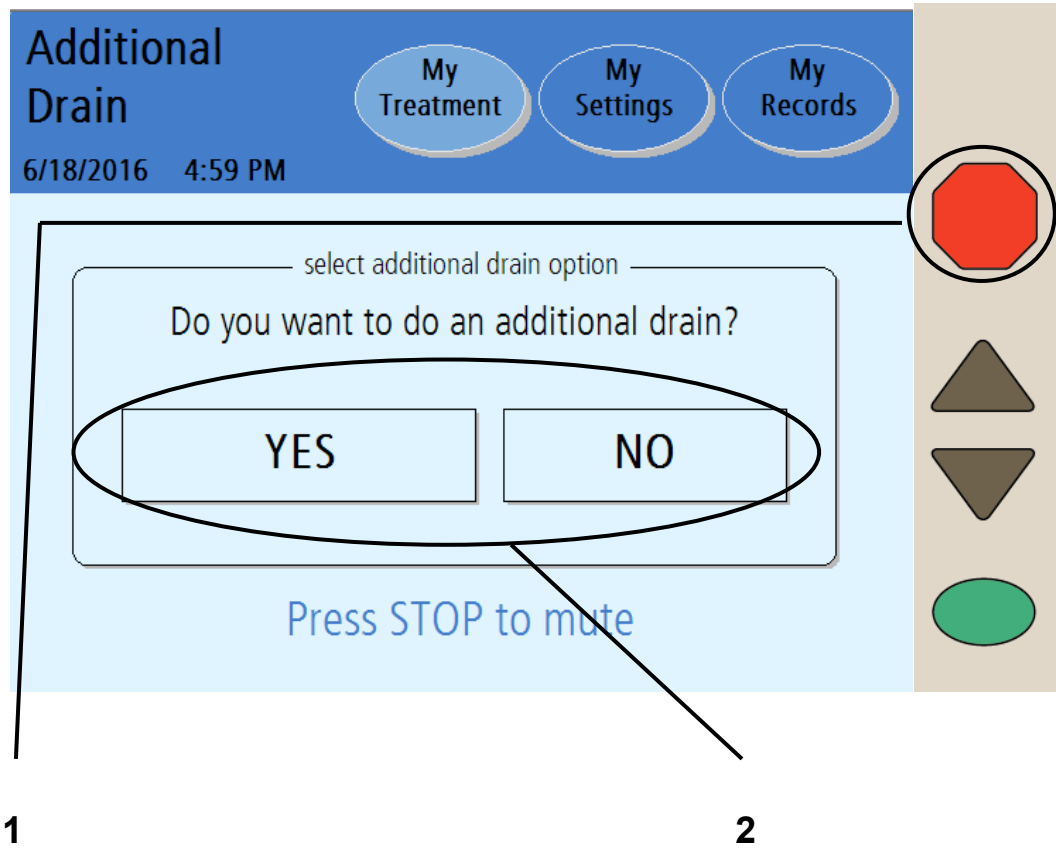

1 Press **STOP**

If the **add. drain** option is set to **YES**, your cyclor will display the “Select additional drain option” screen after the last drain is complete.

If **add. drain alert** option is set to **YES**, your cyclor will alert you with an alarm sound. Press the **STOP** key to silence the audible alarm.

2 Touch **YES** or **NO**

YES option:

To perform an additional drain, touch the **YES** button.

The additional drain will immediately begin draining your abdomen.



Note: An additional drain works the same way as a regular Drain. You may stop it or bypass it as needed.



Note: An additional drain is a planned drain. STAT drain is an unplanned drain.

After your additional drain is complete, your cyclor will begin your Last Fill, if programmed, or it will end the treatment. Your treatment data will show that you performed an additional drain (see page 176 for more information).

NO option:

If you do not want to perform an additional drain, touch the **NO** button. Your cyclor will begin your Last Fill, if programmed, or it will end the treatment.

This Page is Intentionally Blank

Ending Treatment

Ending Your Treatment

Treatment Complete
6/18/2016 5:07 PM

My Treatment My Settings My Records

step 8

- Push in the PIN
- Close blue and catheter clamps
- Insert patient connector into stay.safe Organizer
- Aseptically disconnect yourself

STAT drain

Next ▶

Press next to continue

1

2 (Disconnect)

3

Turn ¼ turn clockwise and push in Blue Button

Close Clamp

The diagram shows a medical device with a grey handle and a blue connector. Callout 1 points to the handle. Callout 2 points to the blue connector, with an arrow indicating a clockwise rotation and a push-in action. Callout 3 points to a blue clamp on the device's tubing, with an arrow indicating it should be closed.

1 Touch **STAT drain**

If you choose to perform a STAT drain before starting to disconnect yourself, touch the STAT drain button. Consult with your PD nurse if you are feeling full. See page 184 for more information.



Note: An additional drain is a planned drain. A STAT drain is an unplanned drain.

2 Disconnect yourself

After your last Drain or Fill of your treatment, your treatment will be complete for the day. When your cycler reaches this screen, you may disconnect.



Warning: You must use aseptic technique as directed by your PD nurse to prevent infection.



Warning: Use a new, sterile stay•safe PIN connector and cap every time you disconnect from your cycler. Be sure to insert the new, sterile cap into the stay•safe New Cap Holder before you disconnect.

To disconnect from your cycler:

- Mask, then wash or sanitize hands as instructed by your PD nurse.
- Insert the stay•safe PIN connector connected to your catheter extension set into the stay•safe organizer clip below the control panel
- Insert a new stay•safe cap on the left side of the organizer
- Turn the blue button on the PIN connector ¼ turn clockwise and push it in to make sure that the PIN has been inserted into the PIN connector
- Close patient line (blue clamp)
- Close catheter extension set clamp
- Use aseptic technique to carefully disconnect your catheter extension set from your patient line and cap off with a new sterile stay•safe cap
- Check that the new sterile stay•safe cap is securely attached to your catheter extension set before removing it from the stay•safe organizer

3 Touch **Next**

Touch the **Next** button to continue. If you set the ‘personal data’ option to YES (see “Options Settings” on page 86), your cyclor will next go to the “Personal Data” screen. If the ‘personal data’ option is not set, turn to page 166.

This Page is Intentionally Blank

Entering Your Personal Health Data

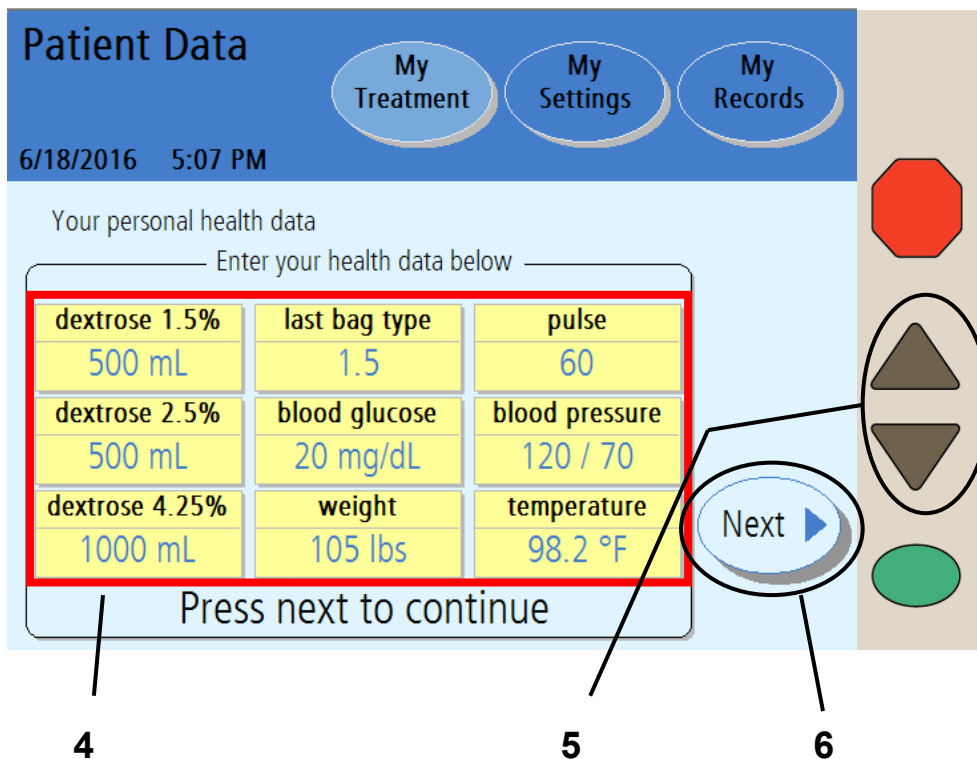
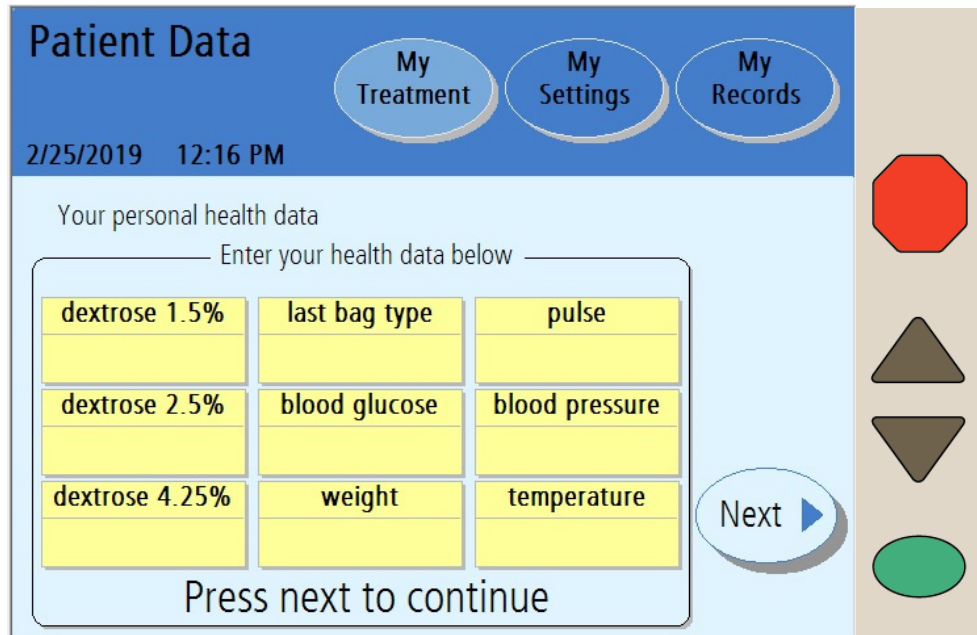

i **Note:** The values shown here are for example only. You must use the values prescribed by your doctor or practitioner.



Note: This screen will appear only if you set the ‘personal data’ option to YES. See “Options Settings,” on page 86.

You must enter your personal health data now—you cannot return to this screen later.

4 Select values

The yellow boxes will be blank when the screen first appears. Touch each individual yellow box, as described below, to enter the desired value. When the yellow box is touched, it changes colors and the previous treatment value displays. Use the **Up/Down Arrow (▼/▲)** keys to adjust the current value. If you did not enter a value previously, the yellow boxes remains blank. Enter in these values exactly as directed by your PD nurse.

The personal health data fields displayed are:

- **Dextrose 1.5%**—The volume of dextrose 1.5% used during treatment
- **Dextrose 2.5%**—The volume of dextrose 2.5% used during treatment
- **Dextrose 4.25%**—The volume of dextrose 4.25% used during treatment
- **Last Bag Type**—Dextrose type of the last bag used (1.5, 2.5, or 4.25)
- **Blood glucose**—Your blood glucose level
- **Patient Weight**—Your weight after your treatment
- **Pulse**—Your pulse in beats per minute
- **Blood pressure**—Measure your blood pressure. Touch the **blood pressure** button to select it, then use the **Up/Down Arrow (▼/▲)** keys to change the first number (systolic). Press the **OK** key to confirm the selection. Use the **Up/Down Arrow (▼/▲)** keys to set the next number (diastolic) and press the **OK** key again to confirm the selection.
- **Temperature**—Measure and enter your temperature.



Note: These values must be properly measured to determine the effectiveness of your treatment.

5 Enter values

When you touch a yellow button, it will turn orange. Use the **Up/Down Arrow (▼/▲)** keys to enter your measured values. Repeat these steps to enter all of your information.

When you are finished entering all your data, press the **OK** key to confirm the selections.

6 Touch **Next**

After pressing the **OK** key, touch the **Next** button to continue. If you press **Next** without entering your Personal Data, no information will be recorded for this treatment date.

This Page is Intentionally Blank

Your Treatment Summary

Treatment Summary

6/18/2016 5:08 PM

My Treatment My Settings My Records

Your treatment summary

total time	8 hr 30 min	dwelt time	lost 0 hr 40 min
total UF	1150 mL	last fill volume	1000 mL
total volume	10000 mL		

Press next to continue

Details

Next ▶

7

8

i **Note:** The values shown here are for example only. You must use the values prescribed by your doctor or practitioner.

7 Review Treatment Summary

This screen displays a summary of your treatment. Your total time, UF, and volume are listed. More specific information is stored in the “Details” screen, available through the **Details** button on the right side of the screen or within the **My Records** screen-button along the top.



Note: You may touch the **Details** button for more information about your latest treatment. The “Details” screen displays information about exchanges, times and volumes. See the next page for more information about this screen.



Note: Your cycler is designed to complete your treatment on time. If, within that time, the dwell was longer than expected (due to an alarm), the **Dwell Time** button will display the word ‘gained’ before the time. If the dwell was shorter than expected (due to a drain or fill bypass), the **Dwell Time** button will display the word ‘lost’ before the time.

8 Touch **Next**

Touch the **Next** button when you are finished reviewing your treatment. Turn to page 166 to continue.

Treatment Summary (continued)

Treatment Summary

6/18/2016 5:09 PM

My Treatment My Settings My Records

Your treatment details for 06/18/2016

cycle #	fill		dwell time	drain		UF vol
	vol	time		vol	time	
0				1900	20	-100
1	2000	15B	60P	2100	18	100
2	2000	13	120	2100	21B	100
3	2000	15	90S	2000	20	0
4	2000	16F	120	2000	20	0
5	2000	14				

all volumes in mL
all times in min

net UF: 100

Back

9

10

i **Note:** The values shown here are for example only. You must use the values prescribed by your doctor or practitioner.

9 Review Treatment Details

This screen displays the cycles of your last treatment. Your information is listed by cycle number and includes:

- Fill volume
- Fill time
- Dwell time
- Drain volume
- Drain time
- Ultrafiltration (UF) volume



Note: If the Drain, Fill, Dwell, or Pause times were interrupted at all, the following letters will appear next to the time to show the interruption:

F – Power Failure

B – Bypass

P – Paused

S – STAT Drain/Additional Drain

10 Touch **Back**

Touch the **Back** button to return to the “Treatment Summary” screen. Then, to continue to the next step on the next page, touch the **Next** button when on the “Treatment Summary” screen.

Remove Set Screen 1

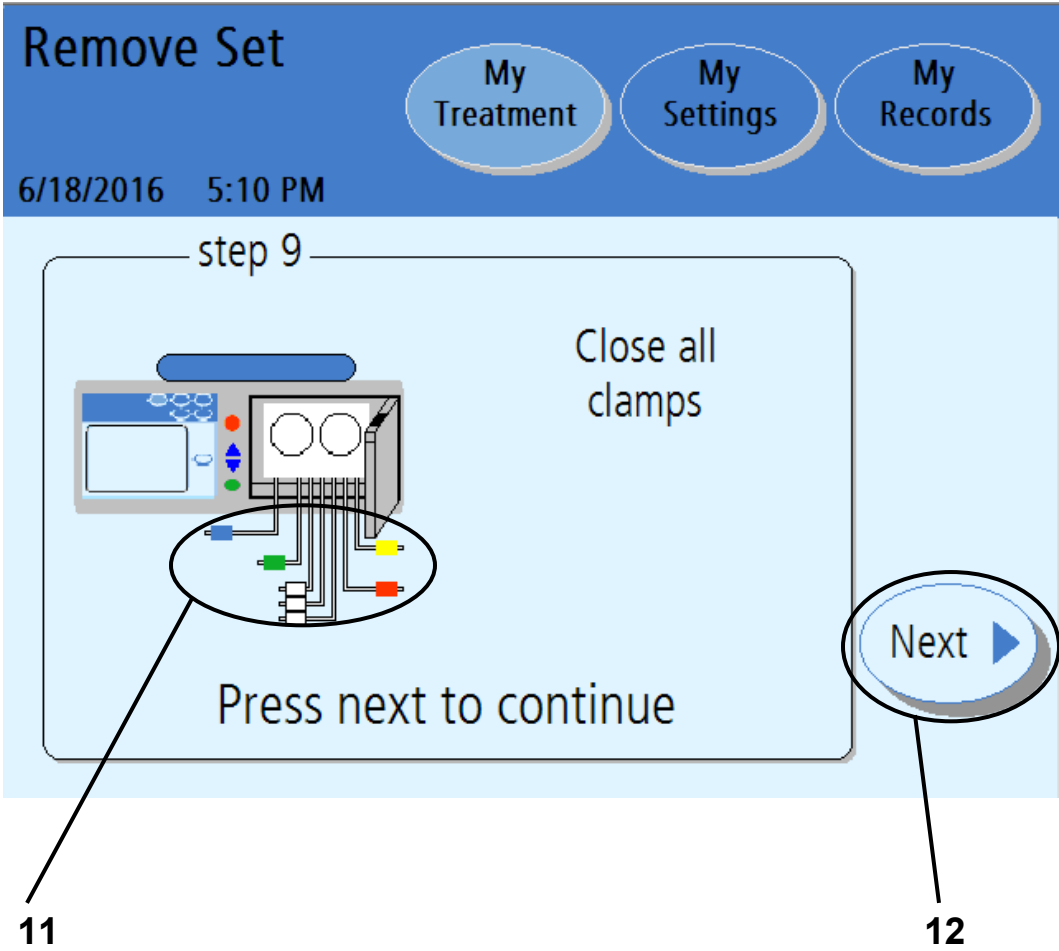

11 Close all clamps

Clamp all lines to prevent any fluid spills when removing the disposable set.



Note: Clamp all lines to prevent spills. Spills can cause damage to carpeting and other surfaces. To contain such spills, your machine should be on a spill-tolerant surface. Clean up spills immediately.

12 Touch **Next**

Touch the **Next** button to continue to the next step.

Remove Set Screen 2

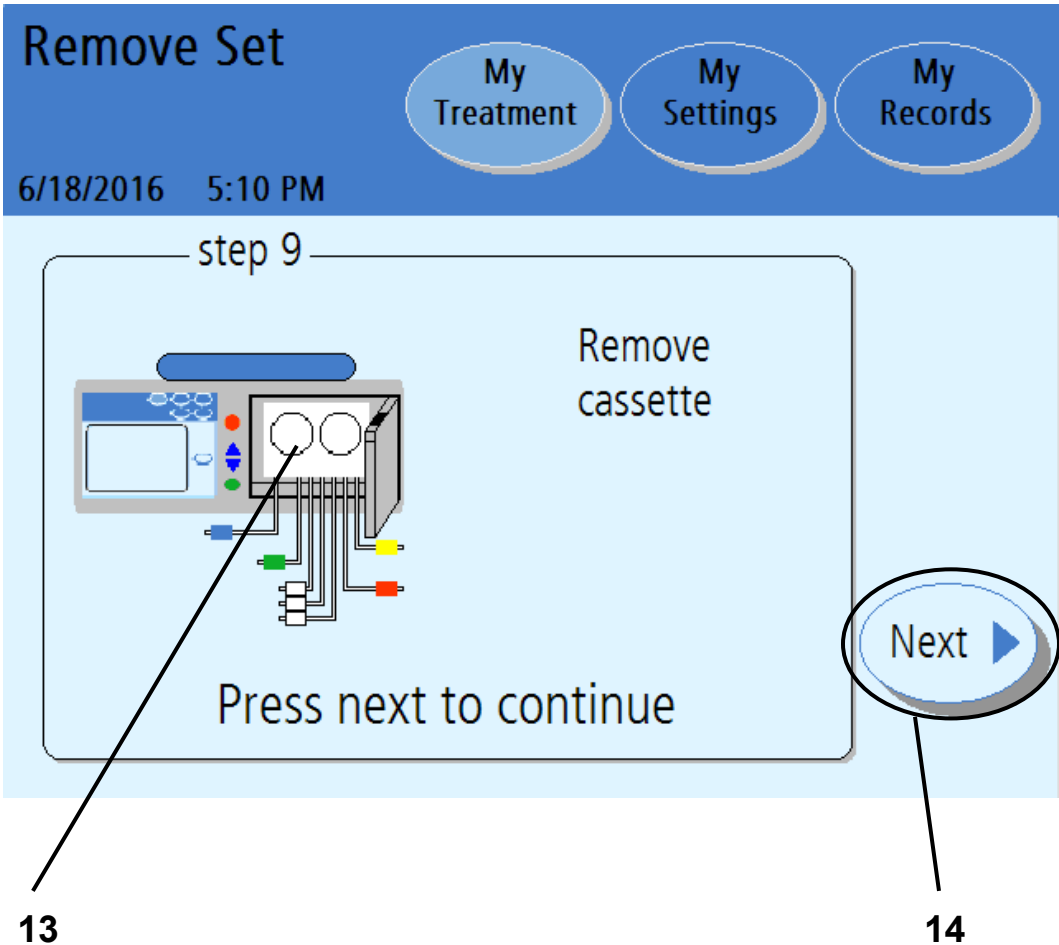

13 Remove cassette

Push the door latch to open the cassette door.



Warning: Be careful of pinch points in moving parts, injury may occur.

Remove the cassette from your machine. Discard your waste materials as instructed by your PD Nurse.



Caution: If your pump module has moisture in it, your cassette may have a leak. **Save your tubing set** and call a Fresenius Medical Care Technical Support Representative immediately at **1-800-227-2572**. You will be contacted about having the used tubing set sample picked up. Please notify your PD nurse about this event.

You should clean your cyclor at this time as instructed by your PD nurse. See “Cleaning Your Cyclor,” on page 248.

Close the cassette door.

14 Touch **Next**

The **Next** button will appear after the door has been closed. Touch the **Next** button to continue.

Power Down Cyclers

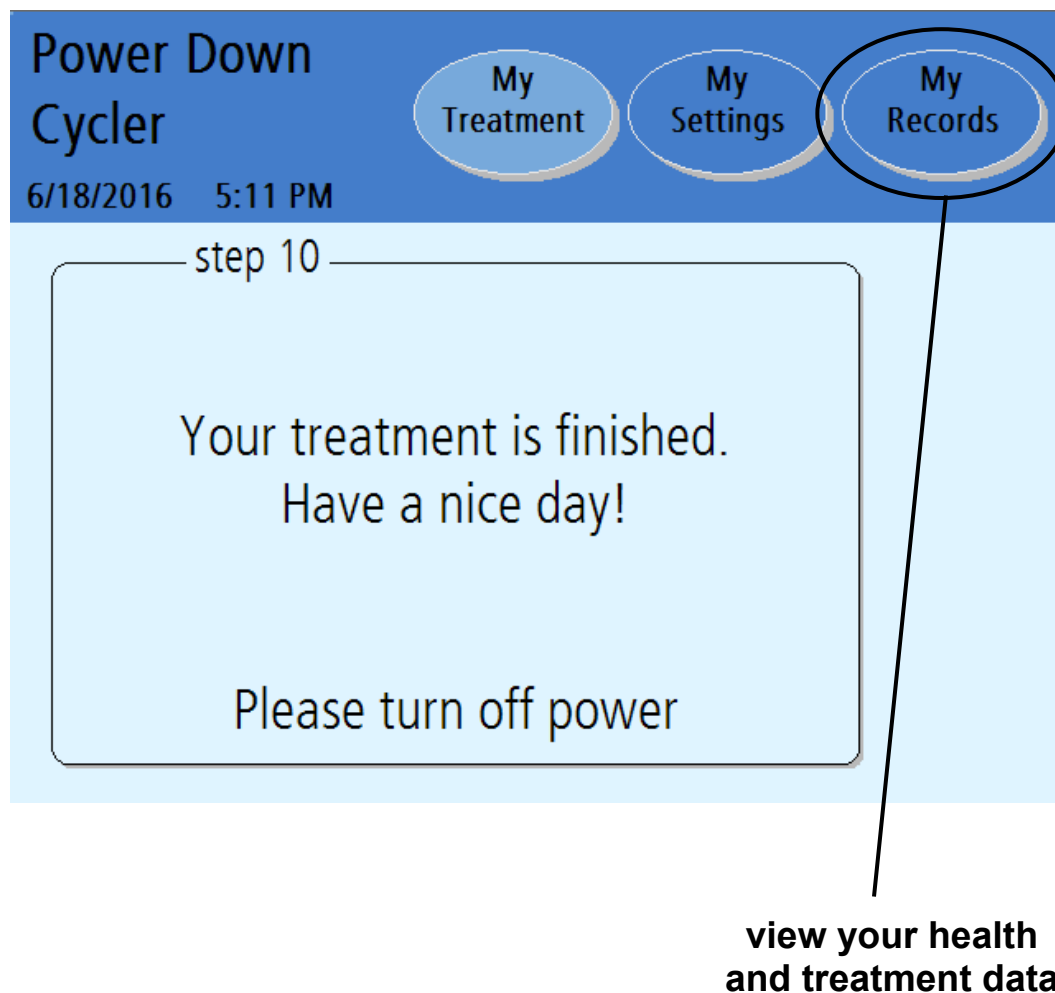

Have a nice day

Locate the switch on the back of your cycler and turn it off.

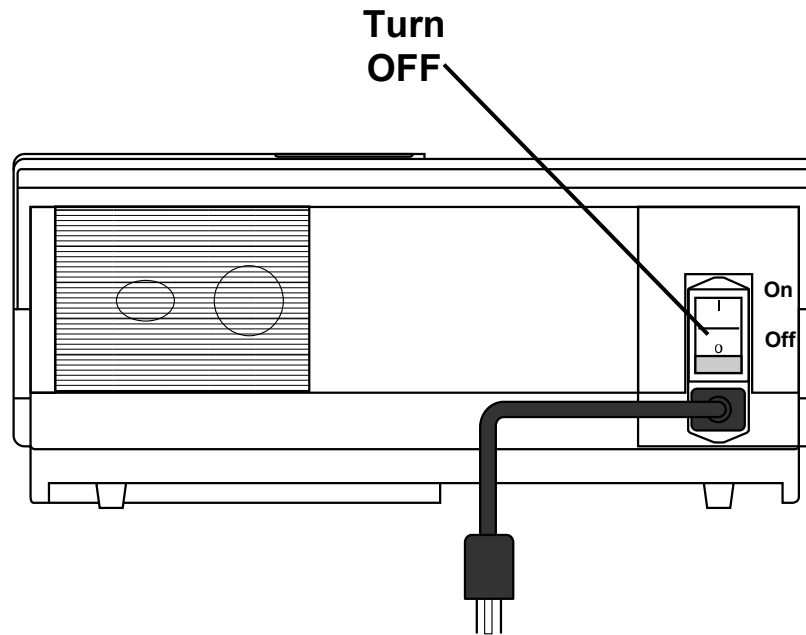

You will need to power on your cycler again before your next treatment.

If you need to remove your IQdrive to take it to your dialysis facility, you may safely remove it at this time.



Caution: Handle your IQdrive with care. When taking your IQdrive to and from your dialysis facility, store it in a plastic bag and keep it clean and dry. Do not leave your IQdrive in a hot car or in the bottom of a purse where it can become damaged.

Touch **My Records**

If you would like to further review your treatment information, restart your cycler and touch the **My Records** screen-button. See page 176 for an explanation of the “My Records” screen.

This Page is Intentionally Blank

Appendix

Appendix

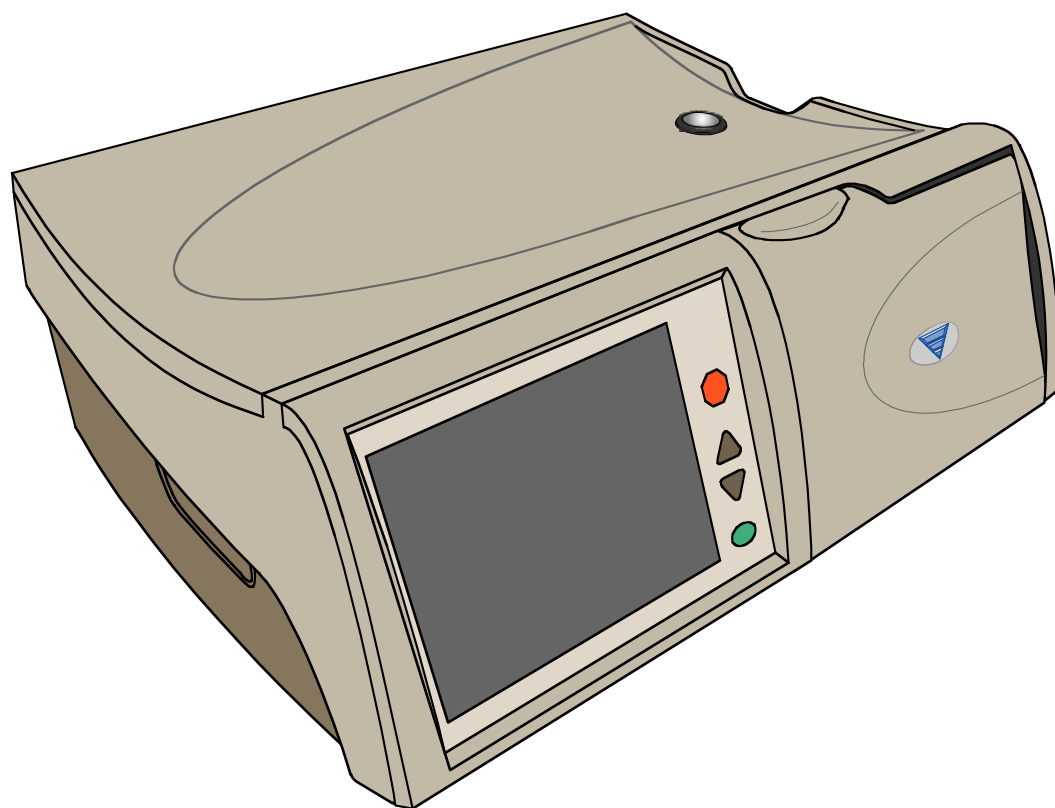

Appendix

The Appendix provides more instructions on different features that you may not use every treatment:

- Viewing the “My Records” screens—Turn to page 176
- Using the **STOP** key—Turn to page 182
- Using the STAT Drain—Turn to page 184
- Bypassing a phase—Turn to page 186
- Using the IQdrive—Turn to page 194
- Moving your Liberty Select Cycler—Turn to page 202

If you get ‘lost’ in any of these screens, simply touch the **Back** button, if available, to go to a previous screen. You may also touch any screen-button in the Status Bar to view other screens. See page 32 for more information on screen-buttons.

The My Records Screen-Button

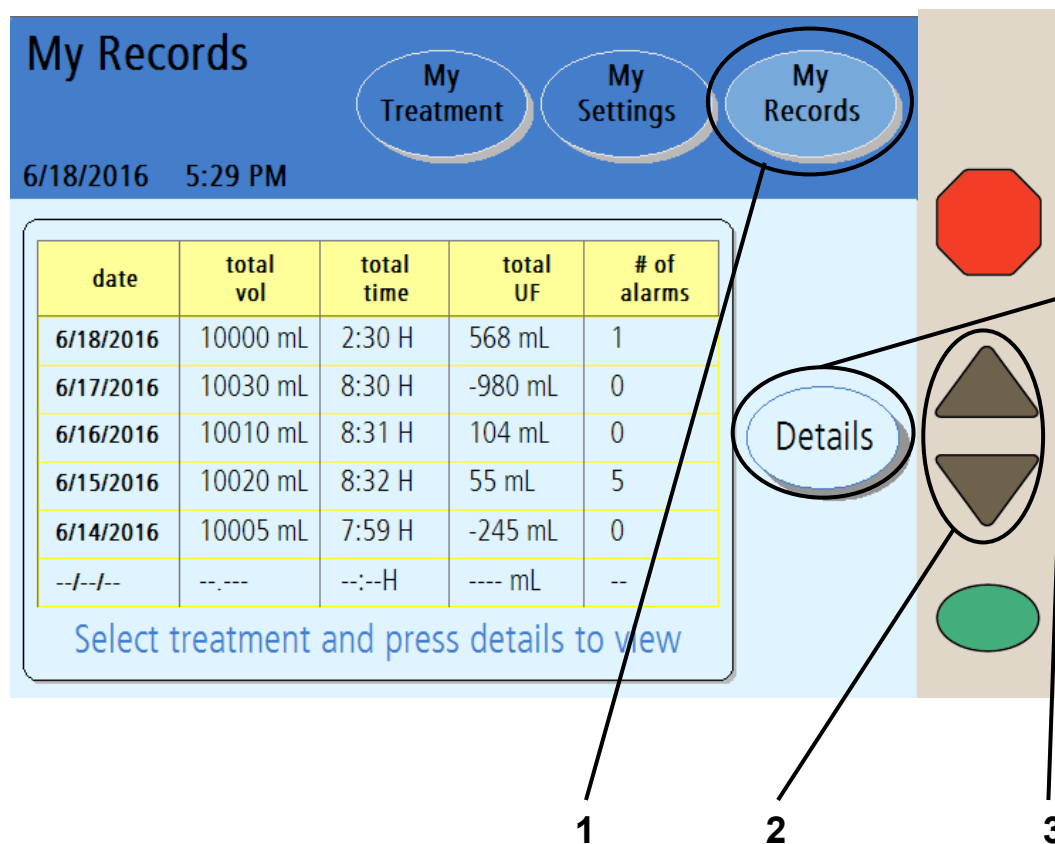

i **Note:** The values shown here are for example only. You must use the values prescribed by your doctor or practitioner.

1 Touch **My Records**

Your treatment history is a record of your past treatments. Your cyclor saved all the information here during each of your treatments. This information cannot be changed. This information is for you and your PD nurse to review.

You may reach the “My Records” screen from any other screen. Touch the **My Records** screen-button to view your treatment history.

2 Select treatment date to view

The select treatment table displays your last six treatments in the main area. Use the **Up/Down Arrow (▼/▲)** keys to scroll through the different pages of your treatments to see older treatment dates, if desired. Touching a treatment date will select that treatment by highlighting it with a blue bar.

Your cyclor saves your last 62 days of treatment data.

3 Touch **Details**

Touch the **Details** button to view the treatment details for the selected date.

Treatment Details

My Records My Treatment My Settings My Records

6/18/2016 5:29 PM

Your treatment details for 06/18/2016

cycle #	fill		dwell time	drain		UF vol
	vol	time		vol	time	
0				1900	20	-100
1	2000	15B	60P	2100	18	100
2	2000	13	120	2100	21B	100
3	2000	15	90S	2000	20	0
4	2000	16F	120	2000	20	0
5	2000	14				

all volumes in mL net UF: 100
all times in min

Back Next

4 5

i **Note:** The values shown here are for example only. You must use the values prescribed by your doctor or practitioner.

4 View treatment details

This screen shows information about the selected treatment date. The treatment date is displayed at the top of the Main Area. The information is organized by the cycle number (#) and shows:

- Fill volume
- Fill time
- Dwell time
- Drain volume
- Drain time
- Ultrafiltration (UF) volume



Note: If the Drain, Fill, Dwell, or Pause times were interrupted at all, the following letters will appear next to the time to show the interruption:

F – Power Failure

B – Bypass

P – Paused

S – STAT Drain/Additional Drain



Note: To go back and select a new treatment date, touch the **Back** button.

5 Touch **Next**

Touch the **Next** button to view your personal health data for the selected treatment.

Your Personal Health Data

The screenshot shows a mobile application interface. At the top, there is a blue header with the text 'My Records' and three circular buttons labeled 'My Treatment', 'My Settings', and 'My Records'. Below the header, the date and time '6/18/2016 5:30 PM' are displayed. The main content area is light blue and contains the text 'Your personal health data'. A red-bordered box highlights a 3x3 grid of data points. To the right of this grid is a circular 'Back' button with a left-pointing arrow. A line connects the 'Back' button to the number '7' below it. Another line connects the bottom-left corner of the red-bordered grid to the number '6' below it.

dextrose 1.5%	last bag type	pulse
500 mL	1.5	60
dextrose 2.5%	blood glucose	blood pressure
500 mL	20 mg/dL	120 / 70
dextrose 4.25%	weight	temperature
1000 mL	112 lbs	98.2 °F

 **Note:** The values shown here are for example only. You must use the values prescribed by your doctor or practitioner.

6 View screen details

This screen displays the personal data you entered at the end of your treatment (see page 157). If you did not enter any data at that time, the field will display 'N/A' for Not Available. The “Your Personal Health Data” screen shows:

- Dextrose 1.5%
- Dextrose 2.5%
- Dextrose 4.25%
- Last bag type
- The weight you entered after treatment
- Blood glucose
- Pulse
- Blood Pressure
- Temperature

7 Touch

Touch the **Back** button to return to the “Your Personal Health Data” screen.



Note: You may touch any of the screen-buttons in the Status Bar to exit the “Personal Health Data” screens.

Using the STOP key

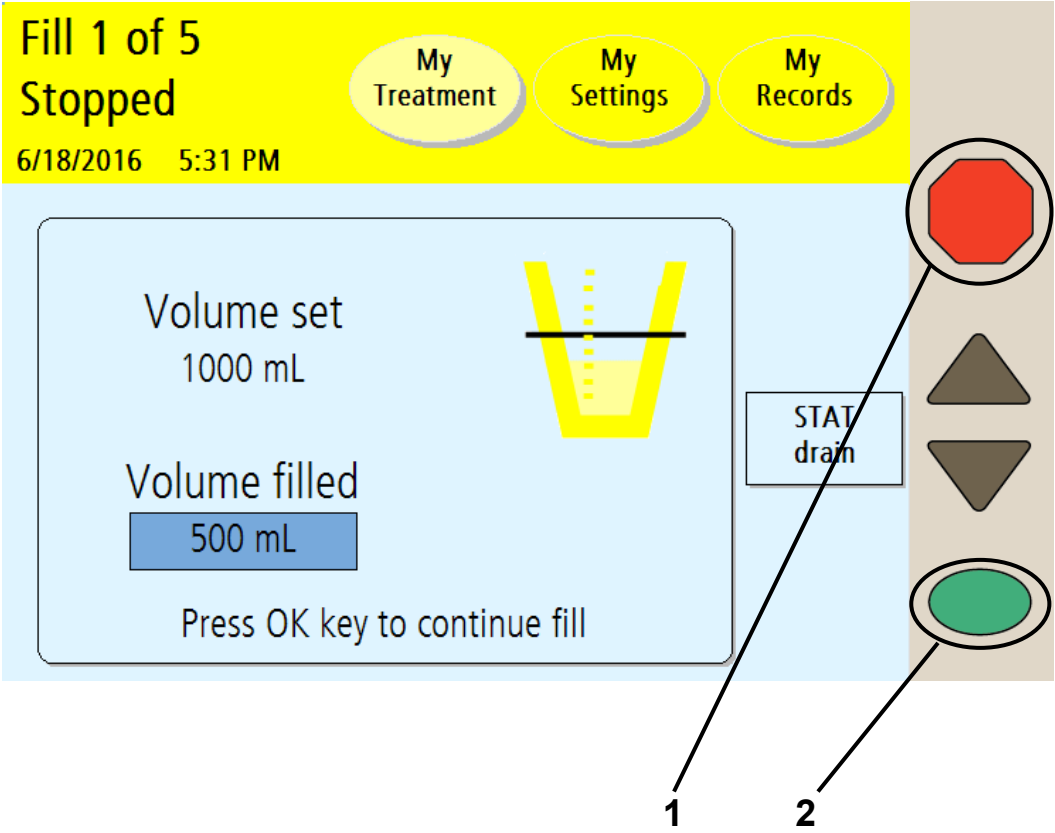

1 Press **STOP**

If it is absolutely necessary to stop your machine when it is performing an action, you may press the **STOP** key. The following green Status Bar machine functions may be stopped:

- Flush
- Prime
- Bag Detect
- Heating
- Drain
- Fill
- Dwell



Note: If you are performing a Fill, Dwell, or Pause, you may choose to do an immediate (STAT) drain at this time. Do not press the **OK** key on your cyclor; instead turn to the next page of this User's Guide for instructions on performing a STAT drain.

2 Press **OK** when you are ready to continue

When your cyclor is stopped, the following occurs:

- The pump motor stops
- The Status Bar changes to yellow
- The word 'stopped' appears at the top of the screen
- The words 'press **OK** to continue' are displayed at the bottom of the screen.

When you are ready to continue, press the **OK** key.

Using the STAT Drain

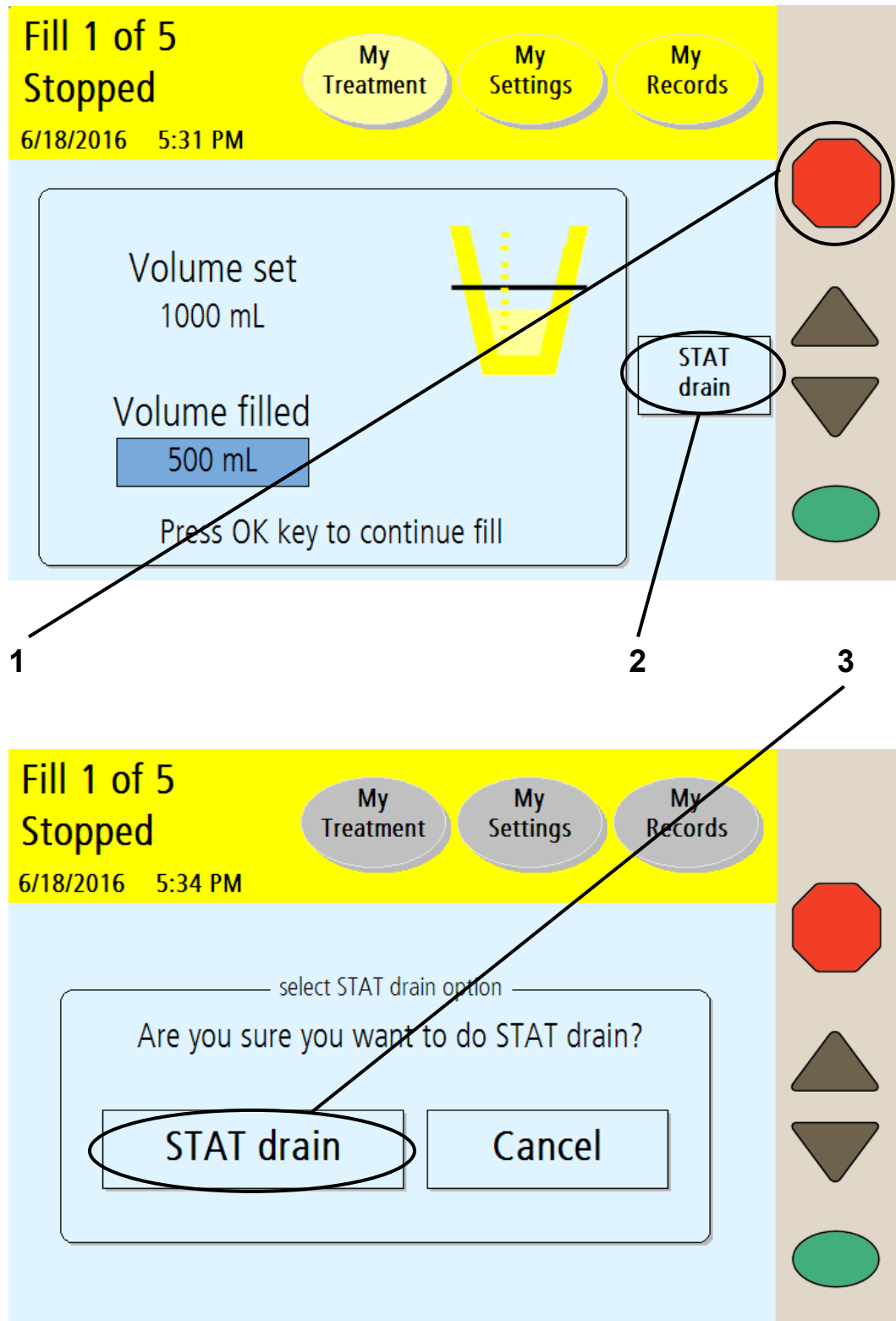

1 Press **STOP**

If you are performing a Fill, Dwell, or Pause, you may choose to do a STAT (immediate) drain. This unplanned Drain will interrupt your Fill, Dwell, or Pause. Press the **STOP** key to first stop your Fill, Dwell, or Pause.

2 Touch **STAT drain**

After the “Stopped” screen displays the message “Press **OK** key to continue fill,” touch the **STAT drain** button.

3 Touch **STAT drain** on the next screen

Your cyclor will display the “Select STAT drain option” screen. To continue with the STAT drain, touch the **STAT drain** button.

If you were previously in a Fill or Dwell cycle, the STAT drain will immediately begin draining your abdomen.

If you were previously in a Pause cycle, your cyclor will ask you to reconnect first. See page 146 for information on how to reconnect after a Pause. After you reconnect, the STAT drain will immediately begin draining your abdomen.

During a STAT drain, your cyclor will display a “Drain” screen with the word ‘STAT’ in the upper left corner to show that it is running an unplanned drain.



Note: A STAT Drain works the same as a regular Drain. You may stop it or bypass it as needed.



Note: An additional drain is a planned drain. STAT drain is an unplanned drain.

After your STAT drain is complete, your cyclor will either begin a short Dwell or Pause (depending on which cycle you interrupted) so your cyclor can prepare the heater bag for your next cycle. Afterward, your cyclor will begin your next programmed Fill, if required. Your treatment data will show that you performed a STAT drain (see page 176 for more information).

If you choose not to perform a STAT drain, either touch the **Cancel** button or wait 10 seconds. Your cyclor will go back to the “Stopped” screen (see page 182).

Bypassing a Phase

To perform bypass, see page 190.

Normal Treatment with Prescribed Drain 0

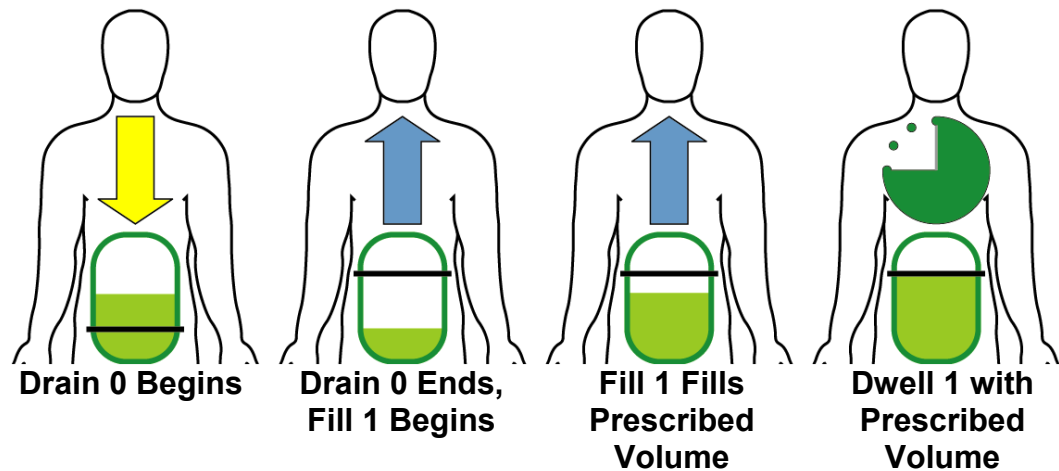

Drain 0 Bypassed With Undrained Peritoneal Cavity (Scenario 2)

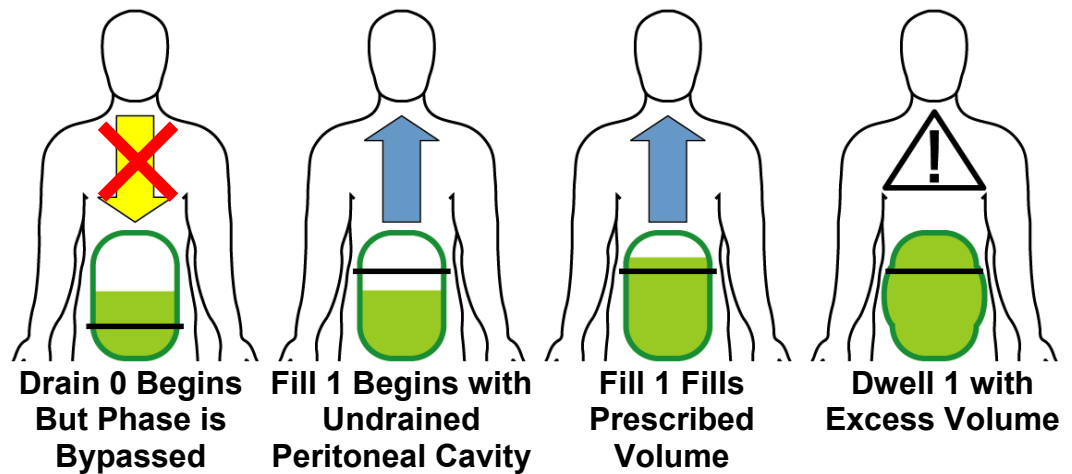

Bypassing a phase

To perform bypass, see page 190.

A bypass is the manual skipping of a phase. Your cyclor will not allow you to bypass any Drain phase after Drain 0 if there is a danger of overfilling. However, Drain 0 may be bypassed under certain circumstances. If using a daytime dwell, please consult your PD nurse before bypassing Drain 0. Before bypassing you must consider that there are three different scenarios that could occur, depending on your prescription. You and your PD nurse must choose the situation that best describes you:

1. *You do not have a Last Fill programmed* and therefore have a ‘dry day’ or very little fluid left in your abdomen. Your cyclor will attempt to drain at least 70% of 50 mL (35 mL) of fluid before switching to Fill 1. (If you changed your drain exit criteria to 85%, however, your cyclor will try to drain at least 85% of 50 mL, which is about 43 mL). You can safely bypass Drain 0 during this time.
2. *You do one or more manual daytime exchanges that you did not program into your cyclor* (see page 128). In this case, your cyclor does not know that you have additional fluid in your abdomen, so you must NOT bypass Drain 0. Wait for your cyclor to finish draining you before continuing to Fill 1.
3. *You have a Last Fill programmed.* During Drain 0 your cyclor will try to drain at least enough so that the next fill will not cause overfilling. Your cyclor may or may not be able to drain all of the fluid out because your body might have re-absorbed some of the fluid. If you are receiving alarms, discuss with your PD nurse to decide if you should bypass.

It is important to understand the risks of overfilling. Overfilling (also known as Increased Intraperitoneal Volume, IIPV) is when you have too much fluid in your abdomen. IIPV/overfill may result in serious injury or death from conditions such as: abdominal wall and/or diaphragmatic hernias, hydrothorax, heart problems including chest pain and heart failure, high blood pressure, pulmonary edema, decreased pulmonary function and

pericardial effusion. Patients and care partners should watch for the potential signs of IIPV. These include:

- Difficulty breathing
- Vomiting or spitting up
- Feeling full, bloated, or overfilled after treatment
- Abdominal pain or discomfort
- Expanded or tense abdomen
- Chest pain
- Increased blood pressure
- Change in mental status
- Leakage of fluid from the PD catheter exit site

If you experience any of these symptoms or feel a large, painful build-up of pressure during your fill, do not finish your fill cycle. Press the **STOP** key and immediately initiate a STAT Drain as instructed by your PD nurse. See page 184 for more information on how to use the STAT Drain feature. Once the fluid is completely drained from your abdomen, call your doctor, practitioner, or PD nurse.

This Page is Intentionally Blank

Bypassing a Phase (continued)

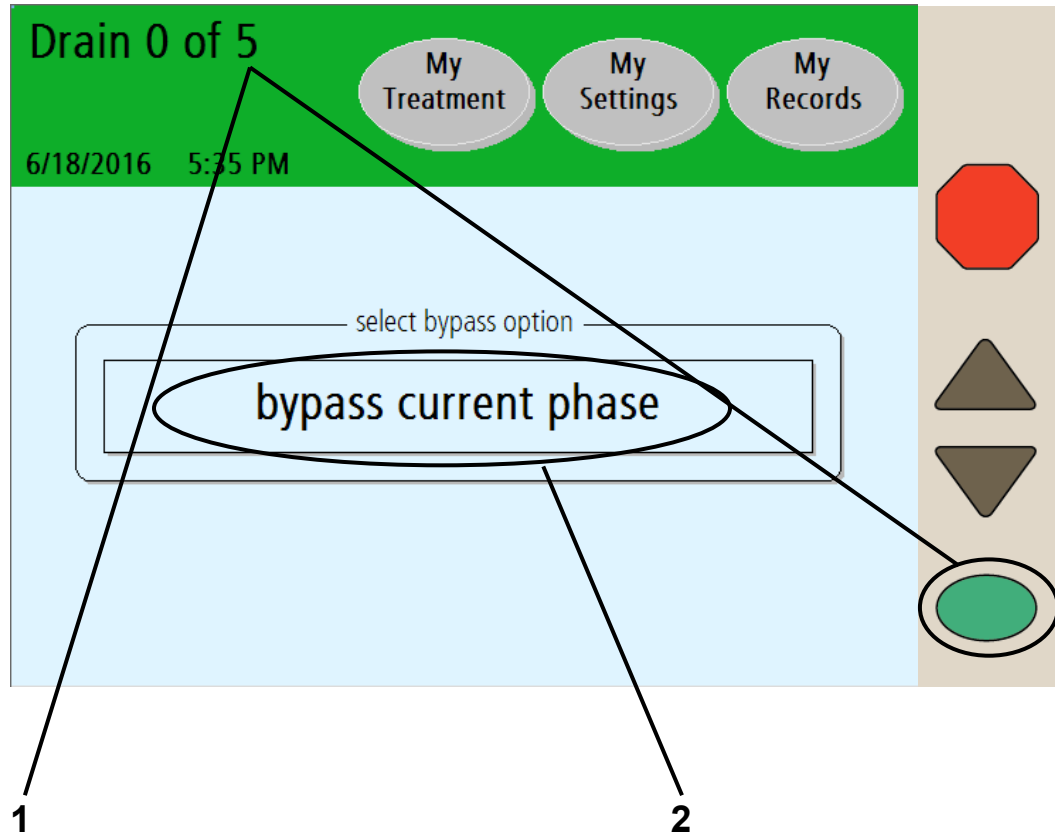

i **Note:** If you accidentally reach this screen and do not want to bypass the current phase, wait a few seconds and the cyclor will return to the previous screen.

1 Press and hold  for four seconds

Bypassing (or skipping) any phase of your treatment should be avoided, unless you've discussed situations that may require bypassing with your doctor, practitioner, or PD nurse. If you must bypass a Drain, Fill, Dwell or Pause phase, press and hold the **OK** key for four seconds to display the "bypass current phase" screen.

2 Touch **bypass current phase**

Touch the **bypass current phase** button to skip the current phase and continue to your next exchange. If your cyclor calculates that there is still too much fluid in your abdomen, you may not bypass. Your cyclor will then display a blinking message, "bypass not allowed at this time" and then go back to the previous screen. Wait until your cyclor drains more fluid from your abdomen before trying to bypass again.



Warning: If you feel a large, painful build-up of pressure during your fill or any of the signs listed on page 190, do not finish your fill cycle. Press the **STOP** key and immediately initiate a STAT Drain as instructed by your PD nurse. See page 184 for more information on how to use the STAT Drain feature. Once the fluid is completely drained from your abdomen, notify your doctor, practitioner, or PD nurse.



Warning: Do not bypass Drain 0 if you have a last fill programmed or if you turn off your cyclor after you have filled. Do not bypass Fill 1 if you have a Pause programmed. You must make sure that you have drained enough fluid from your abdomen before bypassing Drain 0. Failure to do so could result in an overflow situation. Overflowing can cause serious injury or death.



Warning: If you do not program a manual daytime exchange into your Liberty Select Cyclor, your cyclor will not know that you have additional fluid in your abdomen. Do NOT bypass Drain 0. Your Liberty Select Cyclor will switch to Fill 1 when you are finished draining.



Note: If you bypass during a Fill or Dwell, you will either not receive your programmed amount of dialysate or not have as much time to filter out the waste. Your treatment may not be as effective. The letter 'B' will be displayed next to your treatment details in the “My Records” screen to show a bypass occurred. For more information, see “Treatment Details” on page 176.

This Page is Intentionally Blank

Using the IQdrive (Optional)

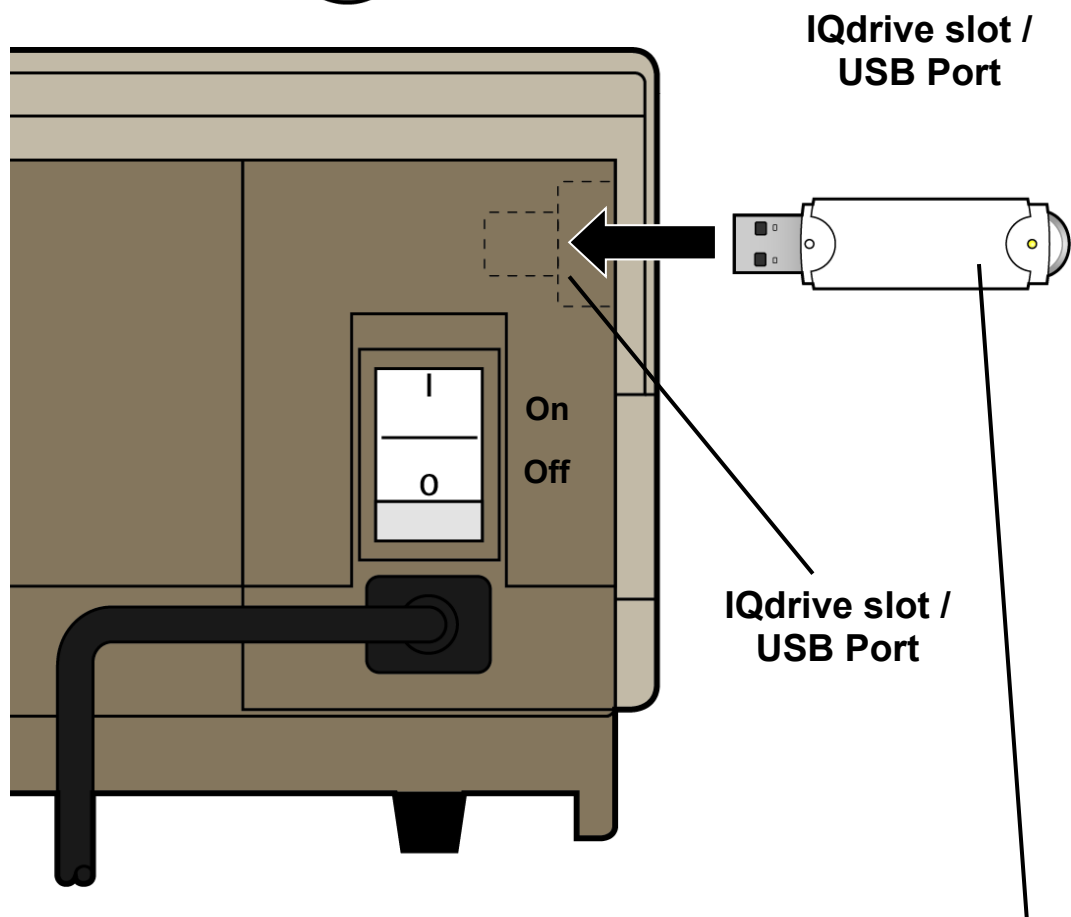
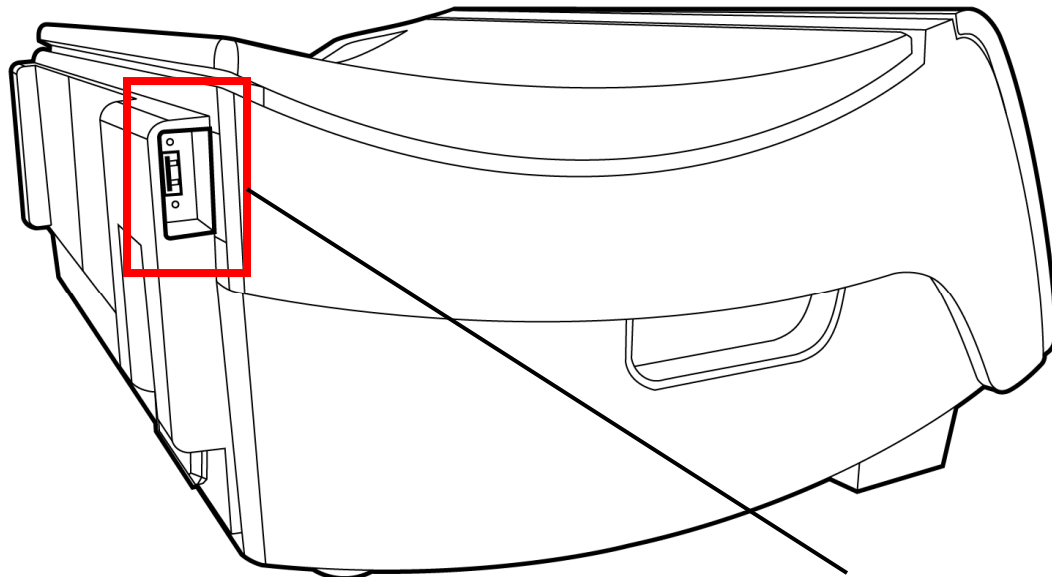

View From Back of Liberty Select Cycler

IQdrive

IQdrive overview

The IQdrive is a device used to transfer your prescription and treatment data. The ‘USB enabled’ option must be set to YES to access it (see page 86). Your PD nurse will provide you with an IQdrive, program it with your therapy settings, and explain how to use it for record-keeping. The IQdrive fits into the USB port on the back of your cyclor.



Caution: Handle your IQdrive with care. When taking your IQdrive to and from your dialysis facility, store it in a plastic bag and keep it clean and dry. Do not leave your IQdrive in a hot car or in the bottom of a purse where it can become damaged.



Caution: Your Liberty Select Cyclor IQdrive is only for use with your Liberty Select Cyclor. Do not use your IQdrive to store your own data from other sources (for example, digital photos from your computer). Storing personal data on your IQdrive will corrupt your treatment data and your Liberty Select Cyclor will no longer be able to record your treatment progress on your IQdrive. Your PD nurse will then need to erase everything on your IQdrive and reformat it.



Note: If the ‘USB enabled’ option is set to YES but no IQdrive is inserted in the IQdrive slot upon power-up, you will have two choices: Either continue without using the IQdrive (by pressing the **OK** key) or insert the IQdrive immediately.

Inserting the IQdrive

Insert the rectangular metal end of the IQdrive into the slot (USB port) in the back, left corner of your cyclor as shown in the picture to the left. The IQdrive can only be inserted in one way. If the device does not fit, turn it over and try again.



Note: If your cyclor displays the message, “IQdrive not detected,” remove the IQdrive and firmly re-insert it to try again.

USB Upload

USB Upload

My Treatment My Settings My Records

6/18/2016 5:36 PM

Program cyclers with new IQdrive settings?

# fills	fill volume	dwel time	Accept	
6	2000 mL	1 hr 0 min		
# pauses	pause volume	fill time		Reject
1	1000 mL	0 hr 15 min		
	last fill volume	drain time		Current Settings
	500 mL	0 hr 20 min		
therapy	total volume	total sleep time		
PD+	9500 mL	7 hr 30 min		

Select option



Note: The values shown here are for example only. You must use the values prescribed by your doctor or practitioner.

USB Upload

The first time you insert the IQdrive and power-up your cyclor, this screen will be displayed. This screen will also be displayed if your PD nurse changes your prescription on the IQdrive.

The main area of the “USB Upload” screen displays the therapy settings to be uploaded onto your cyclor. You must carefully review them to make sure they match your treatment program.



Warning: Your doctor or practitioner must prescribe your entire treatment. Using incorrect values could result in complications that may be severe.

To the right side are three buttons:

- **Accept**—Touch this button to use the new settings for your therapy.
- **Reject**—Touch this button if the IQdrive settings are incorrect. You will use the old therapy settings that are saved to your cyclor.
- **Current Settings**—Touch this button to review your old therapy settings. From that screen you may touch the **IQdrive Settings** button to return to this screen.

After selecting either **Accept** or **Reject**, you will move to the “Ready” screen as usual. Turn to page 52 to continue entering your treatment values or, if already entered, turn to page 98 to begin your treatment.



Note: Do not remove the IQdrive until your treatment is complete. If the device is removed early, your data cannot be saved to the IQdrive. You may keep the IQdrive in your cyclor until your PD nurse asks you to bring it on your next clinic visit.



Note: If you choose to reject the IQdrive prescription, you will have to reject it for every treatment until you insert an IQdrive with an updated prescription. Contact your PD nurse if you need to update your prescription on your IQdrive.

Data Security

The data files transferred via the IQdrive contain only patient data. The data is encrypted with a key based encryption. The encrypted data cannot be read without reapplying the encryption algorithm thereby ensuring the security of the data.

This Page is Intentionally Blank

Using the Wireless Modem (Optional)

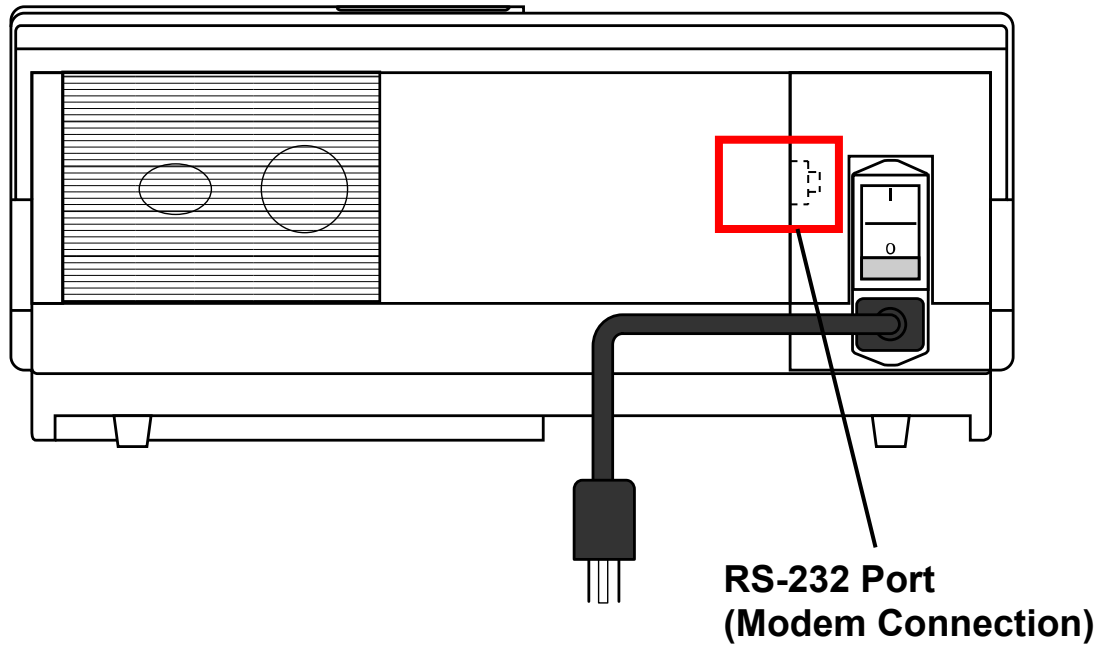

View From Back of Liberty Select Cycler

Wireless Modem overview

The wireless modem is an optional device used to automatically transfer your treatment data at the end of each treatment to the Fresenius Medical Care hosted FTP server. The modem connects to the RS-232 port on the back of your cyclor. Depending on your cyclor, the RS-232 port is either sticking out with a cap covering it, or is mounted flush with the cyclor casing. Your PD nurse will provide you with a wireless modem if needed.



Note: The modem is not in use during treatment.



Note: Your cyclor does not receive any inputs or therapy settings using the modem.



Note: If the treatment data transfer is not successful, your cyclor will retry the transfer at the end of next treatment. To view the treatment data on your cyclor, see “The My Records Screen-Button,” on page 176.



Note: For more information on the wireless modem, see either the Liberty Select Cyclor Wireless Modem User’s Guide (P/N 480106 or P/N 480107), or the Liberty Gateway User’s Guide (P/N 480122).



Note: Do not connect any other modems or accessories to your cyclor that are not approved by Fresenius Medical Care.



Note: Do not modify the modem provided to you by Fresenius Medical Care.



Note: Do not connect or disconnect the modem from your cyclor when the cyclor is powered on.

Data Security

The data files transferred via the external cellular modem contain only the treatment and patient information collected and stored within the Liberty Select Cyclor. The data is encrypted with a key-based encryption. Encrypted data cannot be read without reapplying the encryption algorithm, or ‘key’, thereby ensuring the security of the data.

Moving Your Liberty Select Cycler

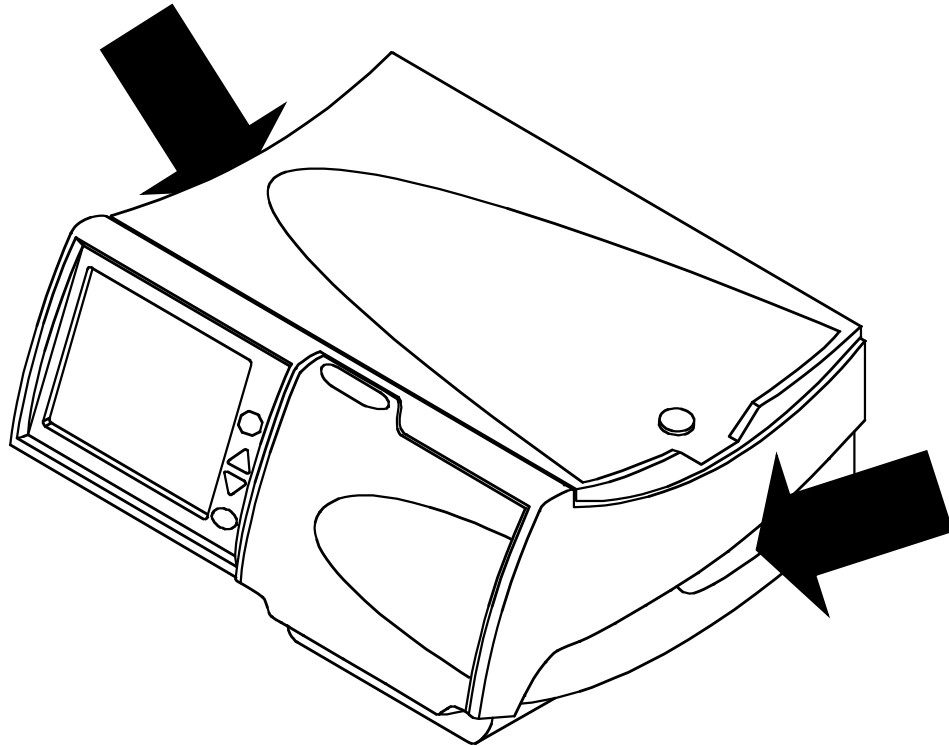

Moving your Liberty Select Cyclor

Your Liberty Select Cyclor is designed to be portable so you may easily continue your dialysis therapy when you travel.

Unplug your cyclor's power cord from the unit before moving it. Hold your cyclor by its handles on either side when lifting it.



Warning: Use proper lifting techniques: lift with your knees and not your back.



Caution: Do not lift your machine by the heater tray.



Caution: If you are using the Liberty cart, be sure to properly balance the solution bags by hanging them on both sides of the cart. Unbalanced bags on the cart may cause it to tip over and damage your machine. The maximum load limit on the Liberty cart in addition to the cyclor is 60 lbs. (2.2 lbs. per Liter of solution). Do not overload the Liberty cart. Make sure that you set the cart brakes to OFF when moving the cart and ON when the cart is stationary.



Note: It is recommended that you pack your cyclor in its shipping box or Liberty Cyclor Travel Case, P/N 180249 when you travel outside of your home. Use the original packing material to protect your cyclor when it is in the box.

This Page is Intentionally Blank

Alarms & Troubleshooting

Warnings and Alarms

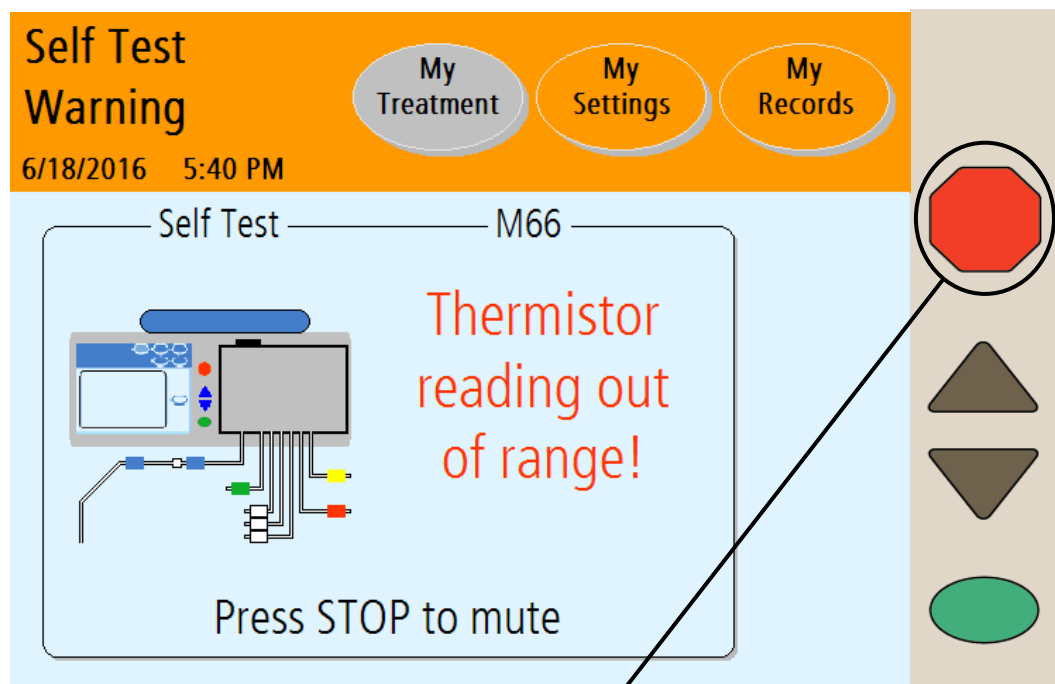

Press STOP key to silence alarm

Warnings and Alarms Overview

Your Liberty Select Cyclor has an advanced system of features that work for your safety. Electronic sensors and diagnostic software constantly monitor your machine's operation. When problems or possible problems are detected, your machine warns you with Status Bar messages and audible alarms.



Warning: All warnings and alarms need your immediate attention. Failure to do so could result in complications that may be severe.



Warning: Contact a Fresenius Medical Care Technical Support Representative at **1-800-227-2572** if an alarm message is displayed and there is **no alarm sound**.

Warnings

During a warning the Status Bar turns orange and an audible alarm sounds. Press the **STOP** key to silence your cyclor. With some warnings, pressing the **OK** key will start a retest and may clear the condition causing the alarm. If available, a **Help** button will appear in the button area (see “Warning: The Help Button” on page 212). You then have the chance to correct the situation by following on-screen instructions. After the problem is corrected, you may continue with your treatment. Types of warnings include:

Heater Warning

The heater temperature is reading too high or too low.

Patient Sensor Warning

The patient sensor is reading incorrectly or is out of range.

Pneumatic Warning

The pneumatic sensor is reading incorrectly or is out of range.

Self Test Warning

A self test has failed but may still be retried.

(continued)

Warnings and Alarms (continued)

Heater Alarm
6/18/2016 5:39 PM

My Treatment My Settings My Records

Heater

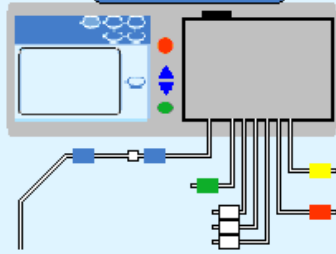

M69

Solution temperature high!

Press STOP to mute

Error Code

The image shows a software interface for a heater alarm. At the top, there is a red header with the text 'Heater Alarm' and the date/time '6/18/2016 5:39 PM'. To the right of the header are three buttons: 'My Treatment', 'My Settings', and 'My Records'. Below the header is a light blue area containing a diagram of a heater unit with various colored wires (blue, green, yellow, red) connected to its base. To the right of the diagram, the text 'Solution temperature high!' is displayed in red. Below this text, it says 'Press STOP to mute'. A callout box labeled 'M69' is connected to the text 'Error Code' below the diagram.

(continued)

Sensor Warning

The sensors are reading incorrectly.

Stopped Warning

You have stopped a function longer than ten minutes. You must press the **STOP** key to silence the alarm and then press the **OK** key to continue if necessary.

System Warning

An error has occurred in the system.

Treatment Warning

A resettable error relating to your treatment has occurred.



Note: Many of the command and control features of this device are performed via the touch screen display. In the event the touch screen does not respond:

- Mask, then wash or sanitize hands as instructed by your PD nurse.
 - Insert the stay•safe PIN connector connected to your catheter extension set into the stay•safe organizer clip below the control panel
 - Insert a new stay•safe cap on the left side of the organizer
 - Turn the blue button on the PIN connector $\frac{1}{4}$ turn clockwise and push it in to make sure that the PIN has been inserted into the PIN connector
 - Close patient line (blue clamp)
 - Close catheter extension set clamp
 - Use aseptic technique to carefully disconnect your catheter extension set from your patient line and cap off with a new sterile stay•safe cap
 - Check that the new sterile stay•safe cap is securely attached to your catheter extension set before removing it from the stay•safe organizer
 - Call Technical Support at **1-800-227-2572**.
-

Alarms

During an alarm, the Status Bar background turns red and an audible alarm sounds. Press the **STOP** key to silence your cyclor. Record the error code and call a Technical Service Representative at **1-800-227-2572**. The following are alarms:

Battery RAM Alarm

Your cyclor cannot access battery RAM.

CRC Alarm

A critical software error has occurred.

EEPROM Alarm

A critical circuit board error has occurred.

Heater Alarm

The heater temperature is reading too high or too low and cannot be corrected.

Pneumatic Alarm

The pneumatic sensor is reading incorrectly or is out of range and cannot be corrected.

Self Test Alarm

A self test has failed after repeated retests.

System Error

A critical error has occurred.

Treatment Alarm

A Treatment Warning was not able to be corrected.

Watchdog Alarm

A critical software error has occurred.

This Page is Intentionally Blank

Warning: The Help Button

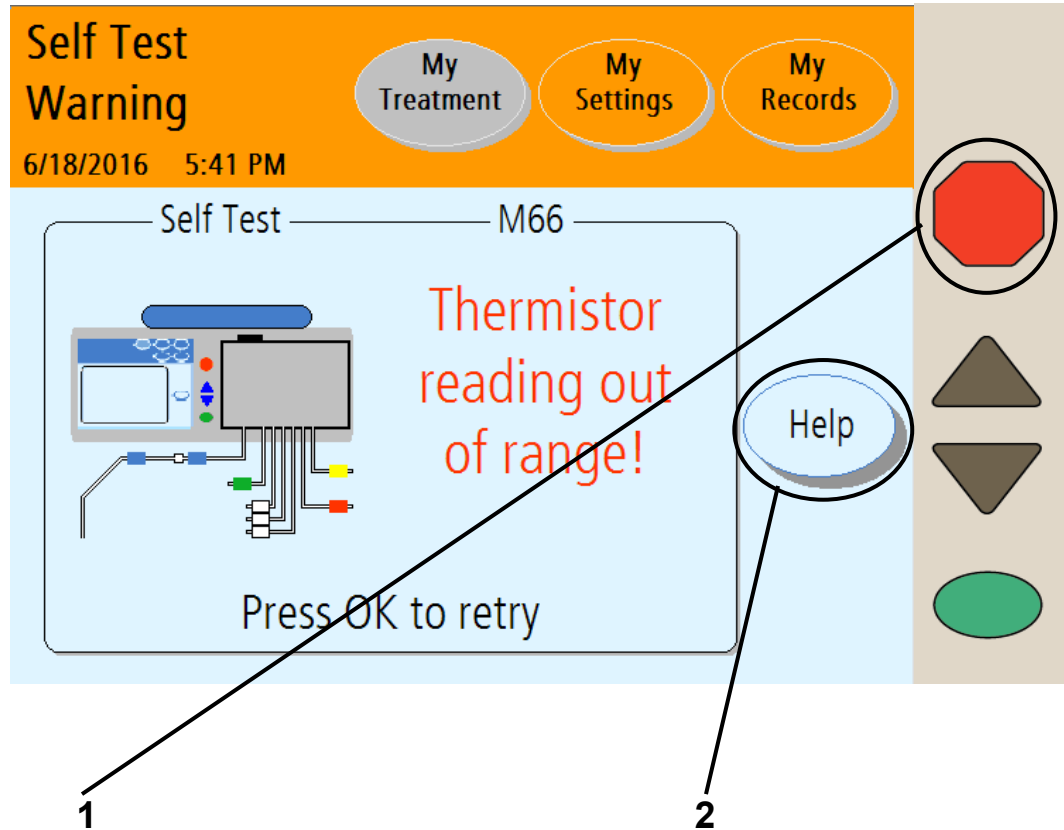

1 Press **STOP**

Press the **STOP** key to silence an audible warning or alarm. If available, a **Help** button will appear in the button area.

2 Touch **Help**

During a warning, your machine may offer a **Help** button to help solve some problems. If you need more information during an alarm, touch the **Help** button.

Warning messages are triggered by conditions and events that occur in your machine during operation. The running function will stop during a warning situation. When the condition causing them is corrected, the machine will reset back to its normal condition. Some conditions may be reset simply by pressing the **OK** key when prompted. In some cases, you can reset the machine yourself to clear the error.



Note: During an alarm or warning, all the screen-buttons in the Status Bar are unavailable.



Note: For more information on correcting alarms, see “Troubleshooting,” page 218.

Warning: Help Screens

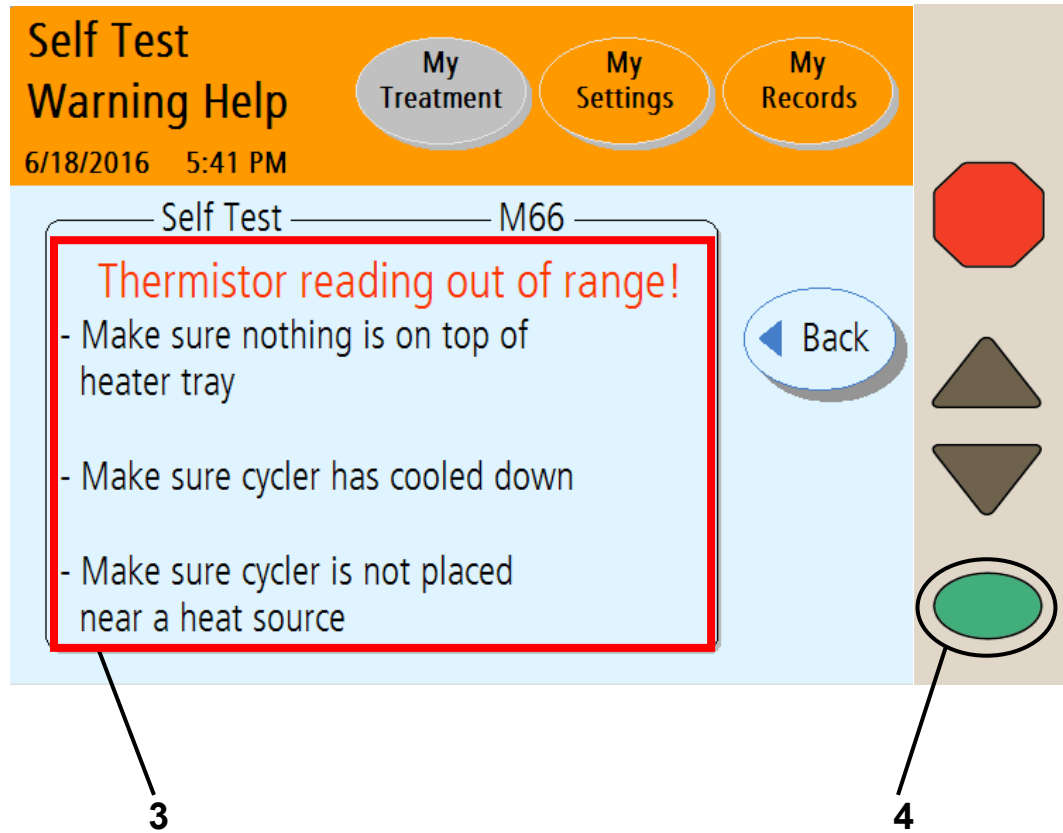

3 Follow steps

Your machine displays specific instructions for each warning. Follow the steps on the screen to correct a warning situation. If you are unable to clear a warning by following the instructions on the screen or in this User's Guide, call a Fresenius Medical Care Technical Support Representative at **1-800-227-2572**.



Warning: Do not continue your treatment until the warning situation has been corrected.

4 Press

When you have corrected the warning situation, press the **OK** key (or **Back** first, then **OK**) to resume the function. You will return to the last step you were on before the warning occurred.

Alarm: Red Status Bar

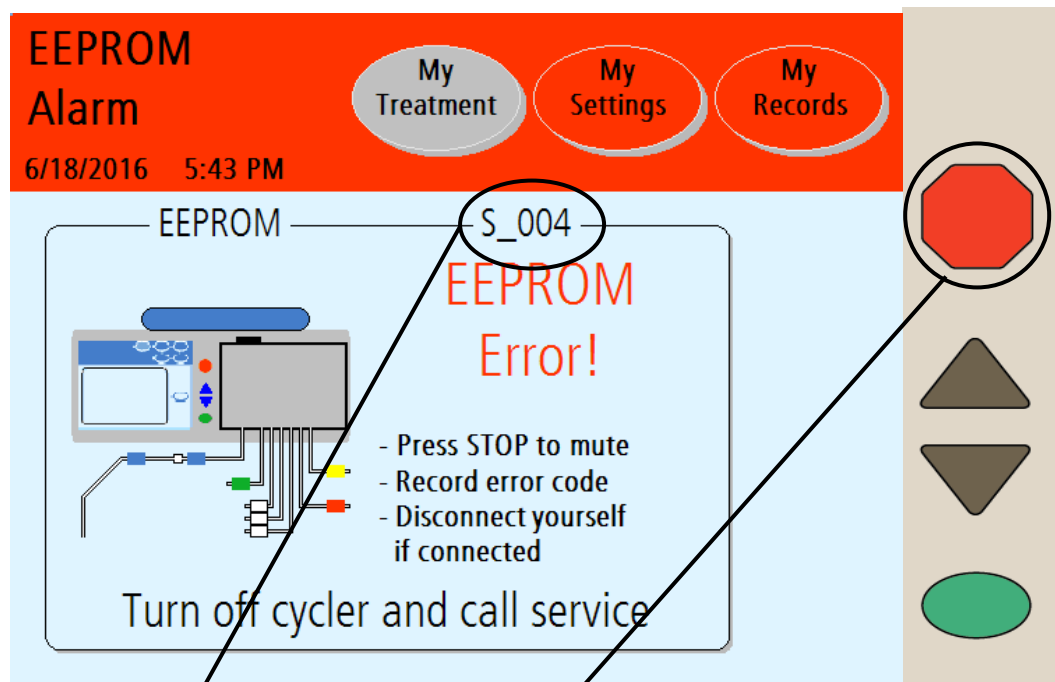

Record Error Code

Press STOP to mute

Turn power OFF

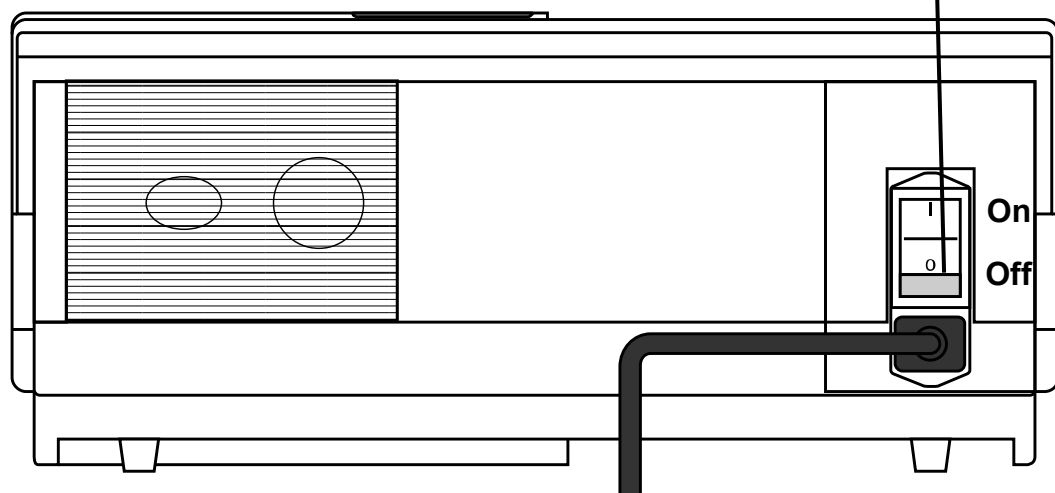

Alarm

During an alarm, the Status Bar turns red. Alarms are not resettable. When you receive an error code:

- Record the error code (located on the right side just below the Status Bar)
- Mask, then wash or sanitize hands as instructed by your PD nurse.
- Insert the stay•safe PIN connector connected to your catheter extension set into the stay•safe organizer clip below the control panel
- Insert a new stay•safe cap on the left side of the organizer
- Turn the blue button on the PIN connector ¼ turn clockwise and push it in to make sure that the PIN has been inserted into the PIN connector
- Close patient line (blue clamp)
- Close catheter extension set clamp
- Use aseptic technique to carefully disconnect your catheter extension set from your patient line and cap off with a new sterile stay•safe cap
- Check that the new sterile stay•safe cap is securely attached to your catheter extension set before removing it from the stay•safe organizer
- Call a Fresenius Medical Care Technical Support Representative at **1-800-227-2572**



Warning: If your machine alarms, do not attempt to use it for treatment.

You will also be asked for your Liberty Select Cycler serial number and software version, which is found on the top of your cycler above the cassette door.

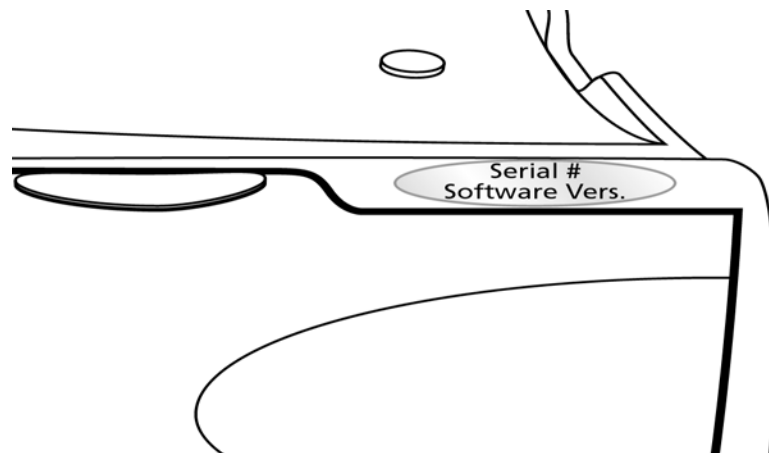

Troubleshooting

The troubleshooting section is a guide to help you troubleshoot machine alarms and messages quickly. These messages are caused by conditions and events that occur in your machine during operation. The messages will reset when the condition causing them is corrected. Some conditions may be reset simply by pressing the **OK** key when prompted. In some cases, you must correct the errors yourself. Alarms in which the Status Bar turns red cannot be resolved by your own action; you must call a Fresenius Medical Care Technical Support Representative at **1-800-227-2572**.



Warning: Doing the recommended action may or may not clear the alarm or warning. Do not continue your treatment until the conditions causing these messages are corrected and the messages are cleared.



Warning: You must use aseptic technique as directed by your PD nurse to prevent infection.



Warning: Use a new, sterile stay•safe PIN connector and cap *every* time you disconnect from your cyclor. Be sure to insert the new, sterile cap into the stay•safe Organizer New Cap Holder before you disconnect.



Note: Refer to the “General Warnings” section, on page 17, for additional warnings.



Note: When your cyclor displays the message “Press the OK key to retry,” try it at least three (3) times before calling your PD nurse or a Fresenius Medical Care Technical Support Representative at **1-800-227-2572**.



Note: Machines taken out of service should be tested and repaired by a qualified FMCNA technician.

When your cyclor prompts you to “disconnect from cyclor”:

- Mask, then wash or sanitize hands as instructed by your PD nurse.
- Insert the stay•safe PIN connector connected to your catheter extension set into the stay•safe organizer clip below the control panel
- Insert a new stay•safe cap on the left side of the organizer
- Turn the blue button on the PIN connector ¼ turn clockwise and push it in to make sure that the PIN has been inserted into the PIN connector
- Close patient line (blue clamp)
- Close catheter extension set clamp
- Use aseptic technique to carefully disconnect your catheter extension set from your patient line and cap off with a new sterile stay•safe cap
- Check that the new sterile stay•safe cap is securely attached to your catheter extension set before removing it from the stay•safe organizer

There are two tables on the following pages that list the meaning of the messages and how the error can be resolved. The first table (page 221) lists every error code and the corresponding alarm or warning message. The second table (page 230) lists all messages in alphabetical order.

(continued)

Be sure to record the error code so you may look up the alarm message. If you call a Fresenius Medical Care Technical Support Representative at **1-800-227-2572**, they will also need this code. The error code is located below the **My Treatment** button:

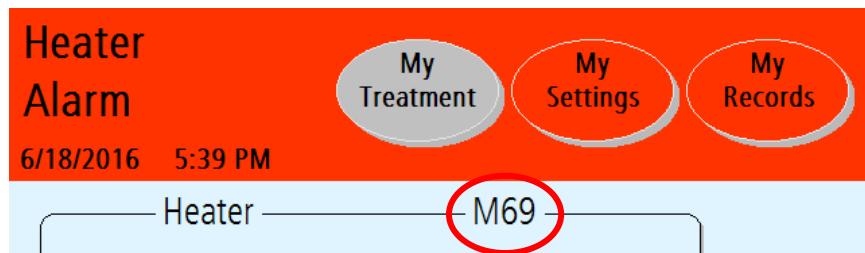
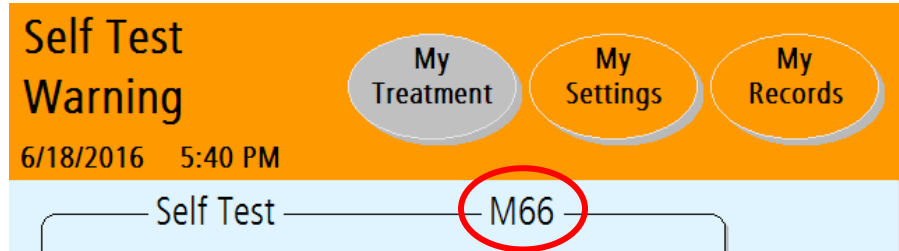



Note: Press the **STOP** key to silence an audible warning or alarm.

Error messages listed by code

Code	Message	Meaning	Action Required
M01 (Subcodes 1 to 20, 22 and 23)	System Error	An unrecoverable error has occurred.	Press STOP to mute. Record error code. Insert PIN. Clamp lines. Insert patient connector into stay.safe Organizer. Aseptically disconnect from cyclor. Turn off cyclor and call service.
M01 (Subcode 21)	System Warning	An unexpected error has occurred.	Press the OK key to retry.
M21	Sensor Warning: Invalid sensor readings!	A sensor is reading incorrectly.	Press the OK key to retry.
M22	Self Test Alarm: Safety Clamp Error!	The safety clamp self test has failed three times.	Press STOP to mute. Record error code. If connected, insert PIN. Clamp lines. Insert patient connector into stay.safe Organizer. Aseptically disconnect from cyclor. Turn off cyclor and call service.

Code	Message	Meaning	Action Required
M30	Self Test Warning: Balloon Valve leak!	The self test has failed due to a possible balloon valve leak during setup.	Press the OK key to retry.
M30.1	Pneumatic Alarm: Balloon Valve leak!	The test has failed due to a possible balloon valve leak during treatment.	Press STOP to mute. Record error code. Insert PIN. Clamp lines. Insert patient connector into stay.safe Organizer. Aseptically disconnect from cyclor. Turn off cyclor and call service.
M31	Treatment Warning: Air detected in cassette!	The test failed due to possible air detection in cassette.	Press the OK key to retry.
M37	Self Test Warning: Patient pressure not constant!	The self test has failed due to an error with one or both of the pressure sensors used to measure fluid pressure in the cassette.	Press the OK key to retry.
M38	Treatment Alarm: Treatment data error!	An unrecoverable error has occurred.	Press STOP to mute. Record error code. Insert PIN. Clamp lines. Insert patient connector into stay.safe Organizer. Aseptically disconnect from cyclor. Turn off cyclor and call service.

Code	Message	Meaning	Action Required
M39	Patient Sensor Warning: Patient sensors against vacuum sensors!	An error with a sensor used to measure fluid pressure in the cassette.	Press the OK key to retry.
M41	Patient Sensor Warning: Patient sensors too high!	An error with a sensor used to measure fluid pressure in the cassette.	Press the OK key to retry.
M42	Patient Sensor Warning: Patient vacuum too high!	An error with a sensor used to measure fluid pressure in the cassette.	Press the OK key to retry.
M44	Treatment Alarm: Flowpath error!	An unrecoverable error has occurred.	Press STOP to mute. Record error code. Insert PIN. Clamp lines. Insert patient connector into stay.safe Organizer. Aseptically disconnect from cyclor. Turn off cyclor and call service.
M44.1	Treatment Alarm: Flowpath error!	An unrecoverable error has occurred.	Press STOP to mute. Record error code. Insert PIN. Clamp lines. Insert patient connector into stay.safe Organizer. Aseptically disconnect from cyclor. Turn off cyclor and call service.

Code	Message	Meaning	Action Required
M44.2	Treatment Alarm: Flowpath error!	An unrecoverable error has occurred.	Press STOP to mute. Record error code. Insert PIN. Clamp lines. Insert patient connector into stay.safe Organizer Aseptically disconnect from cyclor. Turn off cyclor and call service.
M53	Self Test Warning: Pressure out of range!	The self test has failed due to pressures being out of range.	Press the OK key to retry.
M54	Pneumatic Warning: Pressure reading low!	The cyclor's pneumatic pressure is reading too low.	Press the OK key to retry.
M55	Pneumatic Warning: Pressure reading high!	The cyclor's pneumatic pressure is reading too high.	Press the OK key to retry.
M56	Pneumatic Warning: Vacuum reading low!	The cyclor is reading low vacuum pressure.	Press the OK key to retry.
M57	Pneumatic Warning: Vacuum reading high!	The cyclor's vacuum pressure is reading too high.	Press the OK key to retry.
M58	Self Test Warning: Vacuum out of range!	The self test has failed due to vacuum pressures being out of range.	Press the OK key to retry.
M59	Self Test Warning: Pressure leak!	The self-test has failed due to a possible air pressure leak.	Press the OK key to retry.
M60	Self Test Warning: Vacuum leak!	The self test has failed due to a possible vacuum leak.	Press the OK key to retry.

Code	Message	Meaning	Action Required
M61	Self Test Warning: Pressure production low!	The self test has failed due to low pressures.	Press the OK key to retry.
M62	Self Test Warning: Vacuum production low!	The self test has failed due to low vacuum pressures.	Press the OK key to retry.
M66	Self Test Warning: Thermistor reading out of range!	The self test has failed due to a temperature sensor being out of range	Make sure nothing is on top of heater tray. Make sure cyclor has cooled down. Make sure cyclor is not placed near a heat source. Press the OK key to retry.
M67	Self Test Alarm: Fluid temperature out of range!	The solution temperature test has failed.	Press STOP to mute. Record error code. Insert PIN. Clamp lines. Insert patient connector into stay.safe Organizer. Aseptically disconnect from cyclor. Turn off cyclor and call service.
M68	Heater Warning: Heater temperature too high!	The solution temperature test has failed due to high temperatures.	Remove anything from the heater tray other than the heater bag. Make sure cyclor is not placed near a heat source. Press the OK key to retry.

Code	Message	Meaning	Action Required
M69	Heater Alarm: Solution temperature high!	The solution temperature test has failed three times due to high temperatures.	Press STOP to mute. Record error code. Insert PIN. Clamp lines. Insert patient connector into stay.safe Organizer. Aseptically disconnect from cyclor. Turn off cyclor and call service.
M70	Heater Warning: Solution temperature low!	The solution temperature test has failed due to low temperatures.	Cold bags will increase warming time. Be sure to store your bags at room temperature. Check if heater plate (tray) is warm to touch. Check for external cooling sources: Be sure there are no open windows, drafts, or fans or air conditioners blowing on your cyclor. Press the OK key to retry.
M71.1	Pneumatic Alarm: Pressure leak!	The cyclor has failed due to a possible air pressure leak.	Press STOP to mute. Record error code. Insert PIN. Clamp lines. Insert patient connector into stay.safe Organizer. Aseptically disconnect from cyclor. Turn off cyclor and call service.

Code	Message	Meaning	Action Required
M71.2	Pneumatic Alarm: Pressure leak!	The cyclor has failed due to a possible balloon valve air pressure leak.	Press STOP to mute. Record error code. Insert PIN. Clamp lines. Insert patient connector into stay.safe Organizer. Aseptically disconnect from cyclor. Turn off cyclor and call service.
M71.3	Pneumatic Alarm: Pressure leak!	The cyclor has failed due to a possible vacuum leak.	Press STOP to mute. Record error code. Insert PIN. Clamp lines. Insert patient connector into stay.safe Organizer. Aseptically disconnect from cyclor. Turn off cyclor and call service.
M74	Treatment Alarm: Treatment start error!	An unrecoverable error has occurred.	Press STOP to mute. Record error code. Insert PIN. Clamp lines. Insert patient connector into stay.safe Organizer. Aseptically disconnect from cyclor. Turn off cyclor and call service.

Code	Message	Meaning	Action Required
M75	Treatment Warning: Volume error!	Volume is not being pumped although the pumps are moving.	Press the OK key to retry.
M76	Treatment Alarm: Pause time error!	An unrecoverable error has occurred.	Press STOP to mute. Record error code. Insert PIN. Clamp lines. Insert patient connector into stay.safe Organizer. Aseptically disconnect from cyclor. Turn off cyclor and call service.
M77	Treatment Warning: Encoder flag error!	Treatment error.	Press the OK key to retry.
M83	Treatment Alarm: Pump A vs B Volume error!	An unrecoverable error has occurred.	Press STOP to mute. Record error code. Insert PIN. Clamp lines. Insert patient connector into stay.safe Organizer. Aseptically disconnect from cyclor. Turn off cyclor and call service.
MWD	Watchdog Alarm: Watchdog timer Error!	An unrecoverable error has occurred.	Record error code. Aseptically disconnect yourself from cyclor if connected. Turn off cyclor and call service.

Code	Message	Meaning	Action Required
S_002	CRC Alarm: CRC Error!	The CRC is corrupted.	Record error code. Aseptically disconnect yourself from cyclor if connected. Turn off cyclor and call service.
S_003	Battery RAM Alarm: Battery RAM Error!	The battery RAM is corrupted.	Record error code. Aseptically disconnect yourself from cyclor if connected. Turn off cyclor and call service.
S_004	EEPROM Alarm: EEPROM Error!	During startup, the cyclor cannot properly read the EEPROM memory chip.	Record error code. Aseptically disconnect yourself from cyclor if connected. Turn off cyclor and call service.
S_005	System Error	An unrecoverable error has occurred.	Record error code. Aseptically disconnect yourself from cyclor if connected. Turn off cyclor and call service.



Note: Press the **STOP** key to silence an audible warning or alarm.

Error messages listed alphabetically

Message	Meaning	Action Required
Battery RAM Alarm: Battery RAM Error!	The battery RAM is corrupted.	Record error code. Aseptically disconnect yourself from cyclor if connected. Turn off cyclor and call service.
Bypass not allowed!	The operator has tried to bypass the current phase.	No action is required. You cannot bypass while the heater bag is filling, if it does not have enough solution for the next fill. If your cyclor detects that an overfill situation could occur (150% = next Fill + amount not drained from previous Fills), you cannot bypass and the machine will continue to attempt to drain you until it is safe to move on to the next Fill.
CRC Alarm: CRC Error!	The CRC is corrupted.	Record error code. Aseptically disconnect yourself from cyclor if connected. Turn off cyclor and call service.

Message	Meaning	Action Required
<p>Drain complication encountered. Please check patient and drain lines.</p>	<p>Your cyclor checks halfway through a Drain cycle to see if you have drained at least 35% (or 42.5% if Drain exit % option is 85%) of your expected drain volume. If not, your cyclor will beep to alert you of a low drain rate. If you still haven't drained at least 70% (or 85% if Drain exit % option is 85%) of your previous Fill by the end of the Drain, your cyclor will alert you again that you are having drain complications.</p>	<p>Check the Drain Line (Yellow clamp) is not kinked, bent, or clamped.</p> <p>Check that your patient line (blue clamp) is not kinked or clamped.</p> <p>Check for fibrin or clots in the drain line. If so, contact your PD nurse for instructions on what to do.</p> <p>Change positions to move fluid within your abdomen.</p> <p>Check that the Drain Line is properly placed in drainage receptacle such as a toilet, sink or bathtub.</p> <p>Check position of drain bags and make sure they are flat and not on top of each other.</p> <p>Are you constipated? If so, contact your PD nurse for instructions on what to do.</p> <p>Check that your catheter extension set is adequately secured.</p> <p>Press the OK key to retry.</p>
<p>Drain Line is blocked. Please check the drain line.</p>	<p>Your cyclor is having trouble pumping used dialysate to the drain.</p>	<p>Make sure that the Drain Line (Yellow clamp) is properly connected, the clamps are open and there is no kink in the line.</p> <p>Press the OK key to retry.</p>
<p>EEPROM Alarm: EEPROM Error!</p>	<p>During startup, the cyclor cannot properly read the EEPROM memory chip.</p>	<p>Record error code.</p> <p>Aseptically disconnect yourself from cyclor if connected.</p> <p>Turn off cyclor and call service.</p>

Message	Meaning	Action Required
<p>Fill complication encountered. Please check heater, patient, and drain lines.</p>	<p>Your cyclor has recognized that you are not filling as expected.</p>	<p>Make sure that the Heater Bag Line (Red clamp) is properly connected, the clamps are open and there is no kink in the line. Make sure that the Heater Bag is properly positioned on the Heater Tray (see page 112). Make sure that the patient line (blue clamp) is properly connected, the clamps are open and there is no kink in the line. Make sure that the Drain Line (Yellow clamp) is properly connected, the clamps are open and there is no kink in the line. Press the OK key to retry.</p>
<p>Heater Alarm: Solution temperature high!</p>	<p>The solution temperature test has failed three times due to high temperatures.</p>	<p>Press STOP to mute. Record error code. Insert PIN. Clamp lines. Insert patient connector into stay.safe Organizer. Aseptically disconnect from cyclor. Turn off cyclor and call service.</p>
<p>Heater bag not detected.</p>	<p>Your cyclor is having trouble pumping dialysate from the heater bag.</p>	<p>Make sure that the Heater Bag Line (Red clamp) is properly connected, the clamps are open and there is no kink in the line. Make sure that the Heater Bag is properly positioned on the Heater Tray (see page 112) and the cone is broken. Press the OK key to retry.</p>
<p>Heater Warning: Heater temperature too high!</p>	<p>The solution temperature test has failed due to high temperatures.</p>	<p>Remove anything from the heater tray other than the heater bag. Make sure cyclor is not placed near a heat source. Press the OK key to retry.</p>

Message	Meaning	Action Required
Heater Warning: Solution temperature low!	The solution temperature test has failed due to low temperatures.	Cold bags will increase warming time. Be sure to store your bags at room temperature. Check if heater plate (tray) is warm to touch. Check for external cooling sources: Be sure there are no open windows, drafts, or fans or air conditioners blowing on your cyclor. Press the OK key to retry.
IQdrive not detected	The IQdrive is either not inserted or not inserted correctly.	Remove the IQdrive and firmly re-insert it to try again, or press the OK key to ignore the message and continue without using the IQdrive.
IQdrive Port Error	Your cyclor cannot access the IQdrive.	Turn off cyclor, wait 10 seconds, and turn it back on again. If the message is not cleared, call service. If you are not going to use the IQdrive, press the OK key to ignore the message and continue without using the IQdrive.
Make sure the heater bag is on the heater tray and the line is not clamped.	Your cyclor is having trouble pumping dialysate from the heater bag.	Make sure that the Heater Bag Line (Red clamp) is properly connected, the clamps are open and there is no kink in the line. Make sure that the Heater Bag is properly positioned on the Heater Tray (see page 112) and the cone is broken. Press the OK key to retry.
Notice: Draining slowly	Your cyclor has recognized that you are not draining as expected. If “flow alert sound” option is set to “YES”, you may hear several beeps when this message is displayed. This is referred to as a “flow alert”. You do not need to press STOP key at this time.	Change positions to move fluid within your abdomen. Check that your patient line (blue clamp) is not kinked or clamped. Check for fibrin or clots in the drain line. If any are visible, contact your PD nurse for instructions on what to do. Are you constipated? If so, contact your PD nurse for instructions on what to do. Check that your catheter extension set is adequately secured.

Message	Meaning	Action Required
Notice: Filling slowly	<p>Your cyclor has recognized that you are not filling as expected.</p> <p>If “flow alert sound” option is set to “YES”, you may hear several beeps when this message is displayed. This is referred to as a “flow alert”. You do not need to press STOP key at this time.</p>	<p>Make sure that the patient line (blue clamp) is properly connected, the clamps are open and there is no kink in the line.</p> <p>Press the OK key to retry.</p>
Patient line is blocked. Please check the patient line.	<p>Your cyclor has recognized that you are not filling as expected.</p>	<p>Make sure that the patient line (blue clamp) is properly connected, the clamps are open and there is no kink in the line.</p> <p>Press the OK key to retry.</p>
Patient Sensor Warning: Patient sensors against vacuum sensors!	<p>An error with a sensor used to measure fluid pressure in the cassette.</p>	<p>Press the OK key to retry.</p>
Patient Sensor Warning: Patient sensors too high!	<p>An error with a sensor used to measure fluid pressure in the cassette.</p>	<p>Press the OK key to retry.</p>
Patient Sensor Warning: Patient vacuum too high!	<p>An error with a sensor used to measure fluid pressure in the cassette.</p>	<p>Press the OK key to retry.</p>
Please do not insert cassette now. Close Cassette Door.	<p>The cassette is inserted in your cyclor before your treatment has started. Or your cassette door is open when it should be closed.</p>	<p>If the cassette is inserted in your cyclor, remove the cassette and close the door.</p> <p>Make sure the door is closed securely.</p> <p>Press the OK key to retry.</p>

Message	Meaning	Action Required
Please wait for solution to cool down	The Drain phase is finished but the heater bag solution temperature is above 38°C. The cyclor will not allow Fill to begin until the temperature drops below 38°C.	Wait for the heater bag temperature to decrease. If this message occurs frequently, check for external heating sources and make sure that the room temperature is cooler than 92°F (33°C).
Please wait for solution to warm up	The Drain phase is finished but the heater bag solution temperature is still below 25°C. The cyclor will not allow Fill to begin until the temperature reaches 33°C.	Wait for the heater bag temperature to increase. If this message occurs frequently, check for external cooling sources: Be sure there are no open windows, drafts, or fans or air conditioners blowing on your cyclor.
Pneumatic Alarm: Balloon Valve Leak!	The cyclor has failed due to a possible balloon valve air pressure leak during treatment.	Press STOP to mute. Record error code. Insert PIN. Clamp lines. Insert patient connector into stay.safe Organizer. Aseptically disconnect from cyclor. Turn off cyclor and call service.
Pneumatic Alarm: Pressure leak!	An air pressure leak has been detected and the cyclor cannot recover.	Press STOP to mute. Record error code. Insert PIN. Clamp lines. Insert patient connector into stay.safe Organizer. Aseptically disconnect from cyclor. Turn off cyclor and call service.
Pneumatic Warning: Pressure reading high!	The cyclor's pneumatic pressure is reading too high.	Press the OK key to retry.
Pneumatic Warning: Pressure reading low!	The cyclor's pneumatic pressure is reading too low.	Press the OK key to retry.

Message	Meaning	Action Required
Pneumatic Warning: Vacuum reading high!	The cyclor's vacuum pressure is reading too high.	Press the OK key to retry.
Pneumatic Warning: Vacuum reading low!	The cyclor is reading low vacuum pressure.	Press the OK key to retry.
Self Test Alarm: Fluid temperature out of range!	The solution temperature test has failed.	Press STOP to mute. Record error code. Insert PIN. Clamp lines. Insert patient connector into stay.safe Organizer. Aseptically disconnect from cyclor. Turn off cyclor and call service.
Self Test Alarm: Safety Clamp Error!	The safety clamp test has failed three times.	Press STOP to mute. Record error code. If connected, insert PIN. Clamp lines. Insert patient connector into stay.safe Organizer. Aseptically disconnect from cyclor. Turn off cyclor and call service.
Self Test Warning: Balloon Valve leak!	The self test has failed due to a possible balloon valve leak.	Press the OK key to retry.
Self Test Warning: Patient pressure not constant!	The self test has failed due to an error with one or both of the pressure sensors used to measure fluid pressure in the cassette.	Press the OK key to retry.
Self Test Warning: Pressure leak!	The self test has failed due to a possible air pressure leak.	Press the OK key to retry.

Message	Meaning	Action Required
Self Test Warning: Pressure out of range!	The self test has failed due to pressures being out of range.	Press the OK key to retry.
Self Test Warning: Pressure production low!	The self test has failed due to low pressures.	Press the OK key to retry.
Self Test Warning: Thermistor reading out of range!	The self test has failed due to a temperature sensor being out of range.	Make sure nothing is on top of heater tray. Make sure cyclor has cooled down. Make sure cyclor is not placed near a heat source. Press the OK key to retry.
Self Test Warning: Vacuum leak!	The self test has failed due to a possible vacuum leak.	Press the OK key to retry.
Self Test Warning: Vacuum out of range!	The self test has failed due to vacuum pressures being out of range.	Press the OK key to retry.
Self Test Warning: Vacuum production low!	The self test has failed due to low vacuum pressures.	Press the OK key to retry.
Sensor Warning: Invalid sensor readings!	A sensor is reading incorrectly.	Press the OK key to retry.
Solution is warming. Press OK key to start fill...	The solution temperature is cool (25°C/77°F). The user must choose whether or not to wait for it to reach the set temperature.	To continue Fill with cool solution, press the OK key; otherwise, wait until your solution has reached the set temperature to continue. When the set temperature has been reached, it will automatically start the Fill.

Message	Meaning	Action Required
Supply Lines are blocked. Please check the supply lines.	Your cyclor is having trouble pumping out of the solution bags.	Make sure that the solution lines (White and Green clamps) are properly connected, the clamps are open and there is no kink in the lines. Make sure the cones are all broken. Make sure that the bags are not empty. Press the OK key to retry.
System Error	An unrecoverable error has occurred.	Record error code. Aseptically disconnect yourself from cyclor if connected. Turn off cyclor and call service.
System Warning	An unexpected error has occurred.	Press the OK key to retry.
Treatment Alarm: Flowpath error!	An unrecoverable error has occurred.	Press STOP to mute. Record error code. Insert PIN. Clamp lines. Insert patient connector into stay.safe Organizer. Aseptically disconnect from cyclor. Turn off cyclor and call service.
Treatment Alarm: Pause time error!	An unrecoverable error has occurred.	Press STOP to mute. Record error code. Insert PIN. Clamp lines. Insert patient connector into stay.safe Organizer. Aseptically disconnect from cyclor. Turn off cyclor and call service.
Treatment Alarm: Pump A vs B error!	An unrecoverable error has occurred.	Press STOP to mute. Record error code. Insert PIN. Clamp lines. Insert patient connector into stay.safe Organizer. Aseptically disconnect from cyclor. Turn off cyclor and call service.

Message	Meaning	Action Required
Treatment Alarm: Treatment data error!	An unrecoverable error has occurred.	Press STOP to mute. Record error code. Insert PIN. Clamp lines. Insert patient connector into stay.safe Organizer. Aseptically disconnect from cyclor. Turn off cyclor and call service.
Treatment Alarm: Treatment start error!	An unrecoverable error has occurred.	Press STOP to mute. Record error code. Insert PIN. Clamp lines. Insert patient connector into stay.safe Organizer. Aseptically disconnect from cyclor. Turn off cyclor and call service.
Treatment Warning: Air detected in cassette!	The test failed due to possible air detection in cassette.	Press the OK key to retry.
Treatment Warning: Encoder flag error!	Treatment error.	Press the OK key to retry.
Treatment Warning: Volume error!	Volume is not being pumped although the pumps are moving.	Press the OK key to retry.
Watchdog Alarm: Watchdog timer Error!	An unrecoverable error has occurred.	Record error code. Aseptically disconnect yourself from cyclor if connected. Turn off cyclor and call service.

Different People Drain Differently

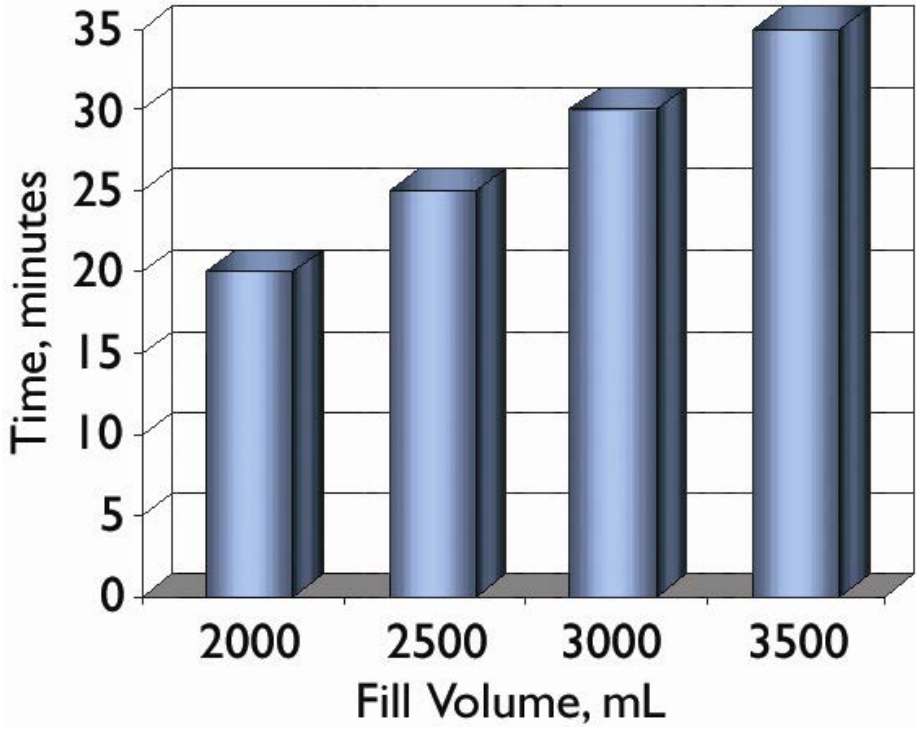

Different People Drain Differently

The way your body and your PD catheter extension set respond to your pumping cyclers may be different. If you've already been doing dialysis as CAPD or on another type of cycler, the amount of time that you need to drain may not be the same as before. Your Liberty Select Cycler is designed to drain at a rate of 100 mL per minute for most Drain cycles. This means that if you program your cycler to drain your peritoneal cavity in a shorter time, the rate would have to be faster and you may have problems with drain alarms.

To help eliminate drain alarms, you and your PD nurse should program your Drain Time to correspond with the amount of fluid you have filled. The graph to the left shows the amount of time in minutes to program into your cycler for your drain times depending on the fill volume that you use.

According to this graph for example, if you have filled with 2000 mL of fluid, you will need 20 minutes to drain.



Note: Patients may experience fewer drain complication alarms in Treatment Based than Cycle Based therapy. If you are in Cycle Based therapy and experiencing drain complications, you should discuss changing your therapy with your doctor, practitioner, or PD nurse.

Power Failure

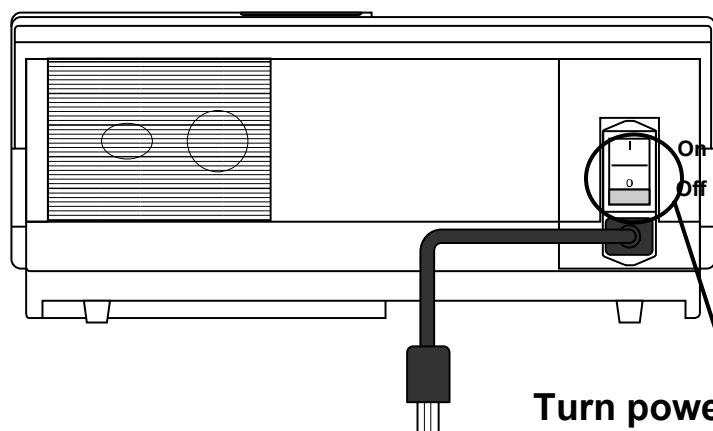
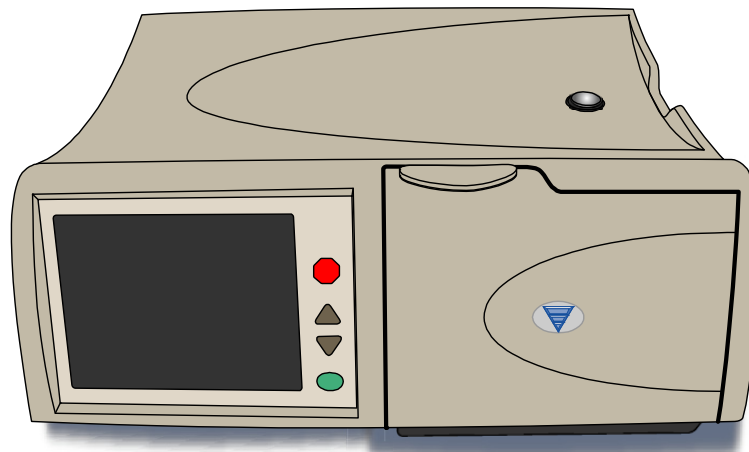

Turn power back ON

Power failure

During a power failure (or if the power switch was turned off), all valves close, the pump stops, and the Touch Screen goes blank.



Note: If the power failure occurs during a Drain, Fill, Dwell, or Pause, your cyclor will keep track of your current location and progress.

You may still continue your same treatment if the power returns within eight hours. Depending on how long the power failure lasts, you may wish to disconnect from your cyclor.

To disconnect from your cyclor:

- Mask, then wash or sanitize hands as instructed by your PD nurse.
- Insert the stay•safe PIN connector connected to your catheter extension set into the stay•safe organizer clip below the control panel
- Insert a new stay•safe cap on the left side of the organizer
- Turn the blue button on the PIN connector $\frac{1}{4}$ turn clockwise and push it in to make sure that a new PIN is inserted in the line
- Close patient line (blue clamp)
- Close catheter extension set clamp
- Use aseptic technique to carefully disconnect your catheter extension set from your patient line and cap off with a new sterile stay•safe cap
- Check that the new sterile stay•safe cap is securely attached to your catheter extension set before removing it from the stay•safe organizer

Power restored

When the power is restored to your cyclor, turn the Power Switch on the back of your machine ON if it is not already on. Your machine will then go through a series of self-tests before you may choose whether or not to continue with your treatment.

(continued)

Power Failure (continued)

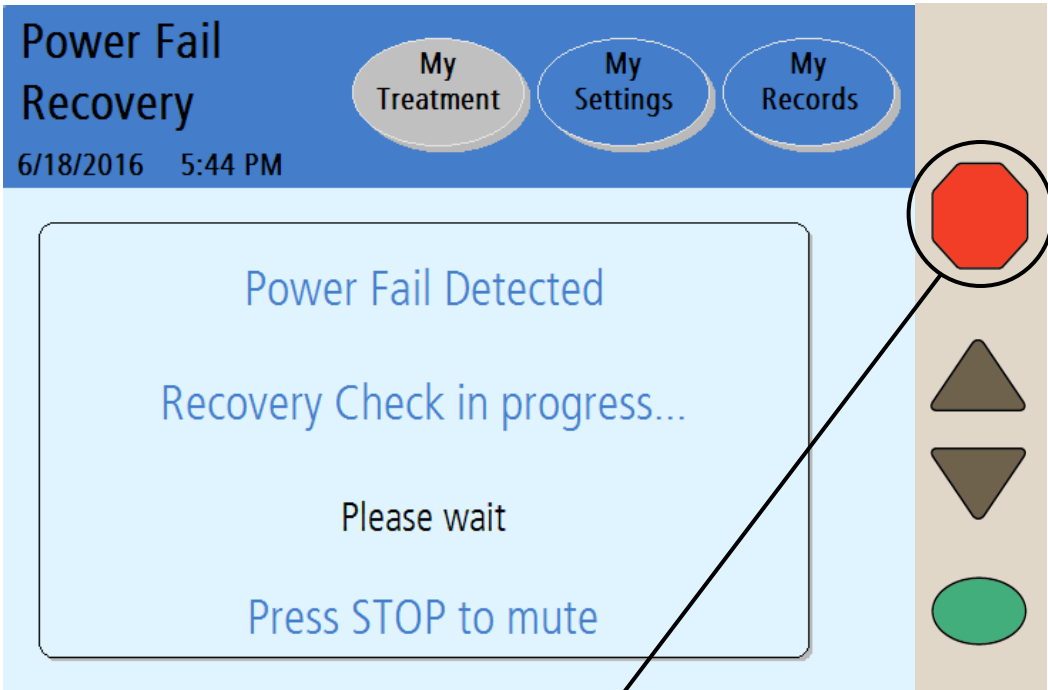

Press **STOP** to mute

(continued)

Press **STOP**

Press the **STOP** key to silence the audible warning. Your cyclor will perform a safety systems check. If the Power Fail Recovery is successful, your machine will beep again. Press the **STOP** key to silence the alarm again. Then you may select the **Resume Treatment** button to continue your Drain, Fill, Dwell, or Pause where you left off.

Follow your PD nurse's power failure instructions to reconnect to your machine if you have disconnected. If you are instructed to, you may continue with your treatment.



Note: The letter 'F' will be displayed next to your treatment details in the "My Records" screen to show a power failure occurred during that treatment. For more information, see "Treatment Details" on page 179.

Recovery failure

If the Power Fail Recovery test fails, you must select the **Cancel Treatment** button and start a new treatment.

Follow the instructions on the screen:

- Mask, then wash or sanitize hands as instructed by your PD nurse.
- Insert the stay•safe PIN connector connected to your catheter extension set into the stay•safe organizer clip below the control panel
- Insert a new stay•safe cap on the left side of the organizer
- Turn the blue button on the PIN connector ¼ turn clockwise and push it in to make sure that a new PIN is inserted in the line
- Close patient line (blue clamp)
- Close catheter extension set clamp
- Use aseptic technique to carefully disconnect your catheter extension set from your patient line and cap off with a new sterile stay•safe cap
- Check that the new sterile stay•safe cap is securely attached to your catheter extension set before removing it from the stay•safe organizer

- Press the **Next** button to continue
- Close all clamps
- When prompted, open the door and remove the cassette
- Restart your entire treatment with fresh dialysate bags and a new cassette



Note: If your power failure lasts longer than eight hours, you may not resume your treatment.

Cleaning, Specifications, Index, and Glossary

Cleaning Your Cyclor

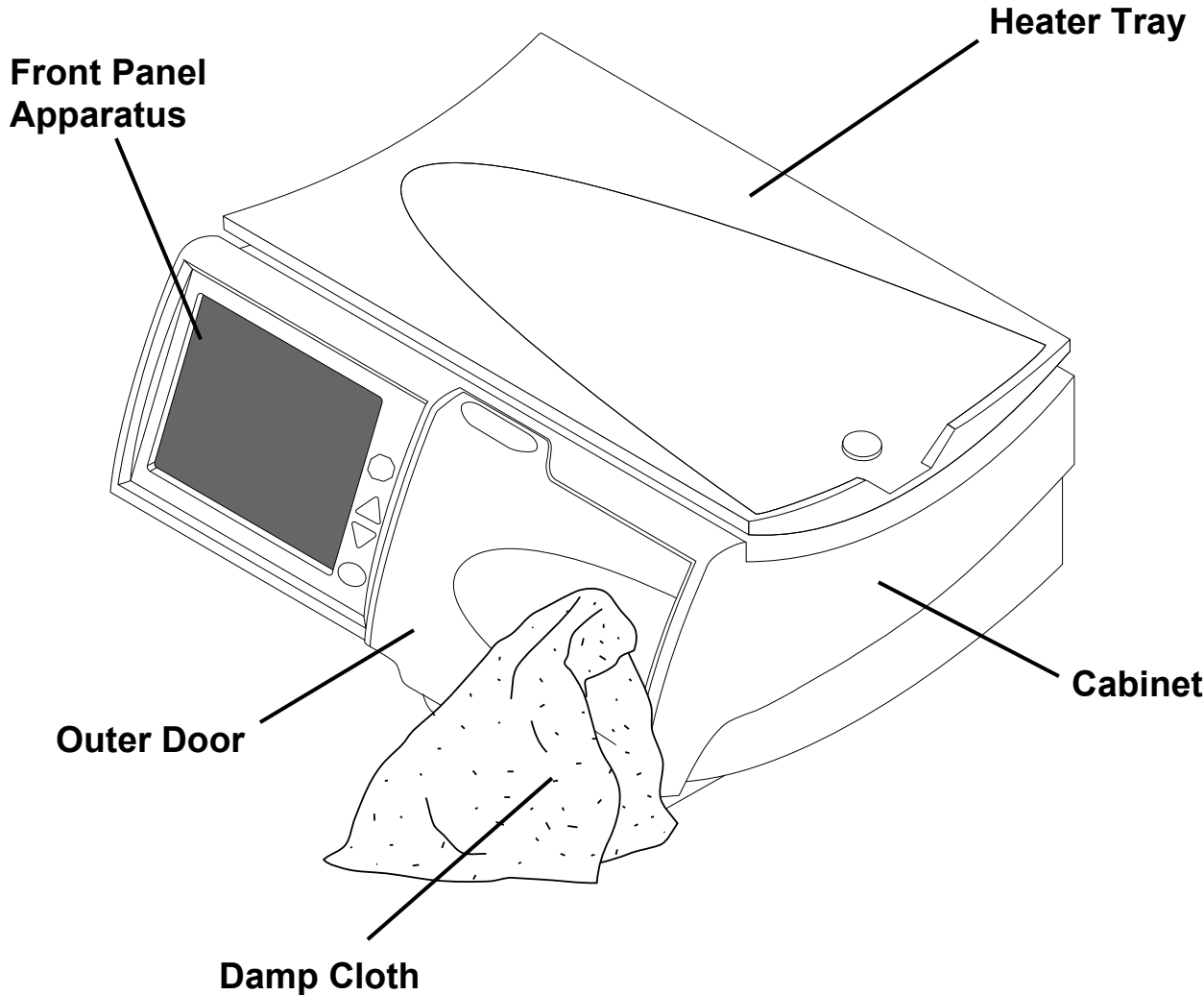

Cleaning your cyclor

The Liberty Select Cyclor is not sterile equipment, however, you should keep your Liberty Select Cyclor clean and dry at all times. Clean the exterior surface of your machine using a damp cloth and a diluted (1:100) bleach solution or other suitable hospital disinfectant. See adjacent illustration for areas to be cleaned.

Use surface cleaner in small amounts to avoid excess cleaner from entering the interior of your machine. Rinse off cleaning solutions with a water-dampened cloth, especially if a corrosive cleaner such as bleach is used.

If you need to clean your stay•safe organizer, you may wash it with warm soapy water or place it in the top rack of your dishwasher.



Caution: Do not allow any fluid to drip into your cyclor or onto the pump module. The cyclor must be OFF when you are cleaning it to prevent fluid from entering the pump module. If any fluid gets inside your cyclor, you must contact a Fresenius Medical Care Technical Support Representative immediately at **1-800-227-2572**. Clean fluid spills immediately to prevent moisture from possibly damaging your machine. Your machine should be placed on a water-tolerant surface, and spills should be cleaned up immediately.



Caution: Do not touch the white pressure sensors in the pump module. Pressing on the pressure sensors may damage them.



Caution: Do not use foaming type cleansers or disinfectants containing alcohol or quaternary ammonium compounds like N-alkyl (C12-C18) dimethyl benzyl ammonium chloride (benzalkonium chloride). These chemicals attack the polycarbonate plastics used in your machine. Read the product labels and follow the instructions. Do not use spray bottles.

Periodically check your Liberty Select Cyclor for:

- Damage to the cabinet
- Loose or missing pieces

There is no other preventative maintenance for your cyclor.

If your cyclor needs service, call an FMC Technical Support Representative at **1-800-227-2572**.

Machine Specifications

Overall

Dimensions	21.5 cm H x 41.28 cm D x 47.63 cm W
Weight	14.5 ± 1.8 kg (32 ± 4 lbs.)

Operating Conditions

Temperature	15-33°C (59 – 92°F)
Rel. Humidity	30-75% (EN 60601-1-2)
Atmospheric Pressure Range	70 kPa to 106 kPa
Noise Level	Does not exceed 40 dBA

Transportation and Storage Conditions

Temperature	-31 to 54°C (-25 to 130 °F)
Rel. Humidity	Non-condensing
Atmospheric Pressure Range	50 kPa to 106 kPa

Electrical

Power Supply	Single phase or two phase center-tapped AC 100-240 V, 50/60Hz
Power consumption	480 Watts at 100V 700 Watts at 240V
Circuit Breaker	6 Amp. breaker contained in Power Entry Module
External Connections	USB Port IEC 60601-1:1988, A1:1991, A2:1995 Clause 6.8.2a, 6.8.2c (Accessories, SIP/SOP connections) Accessories equipment connected to the analog and digital interfaces must be certified to the respective IEC standards (i.e. IEC 60950 for data processing equipment and IEC 60601-1 for medical equipment). Furthermore all configurations shall comply with the system standard IEC 60601-1-1. Persons who connect additional equipment to the signal input part or signal output part configure a medical system, and are therefore responsible that the system complies with the requirements of the system standard IEC 60601-1-1. If in doubt, consult the Technical Support department at 1-800-227-2572 or your local representative.

Electro-magnetic compatibility See EMC Declaration on page 254

Electrical Safety (UL 60601-1)

Protection against electric shock Type: Class I equipment
Degree: Type BF Applied Part

IP Rating IPX0. Meets the requirements of IEC 60601-2-39 (Clause 44.3) regarding degree of protection against ingress of water.

Mode of Operation Continuous Operation

Equipment not suitable for use in the presence of a flammable anesthetic mixture with air or with oxygen or nitrous oxide.

User Interface

Language The operating screens may be set to either English (USA), French (Canada), or Spanish (Mexico)

Touch Screen LCD display reacts to fingertip pressure

Keys Up ▲, Down ▼, STOP, OK

Hardware Settings

Alarm Loudness 1-20 (50-90 dB)

Key Loudness 0-20

Screen Blank-ing Delay 10 minutes

Screen Brightness 1-10

Solution

Bag Volumes 2000, 3000, 5000, 6000 (v2.8.4 software or later) mL

Initial Fill Volume Range 500 to 4000 mL

Temperature Fixed at 37°C ±1°C (98.6°F ±1.8°F)
Minimum 25°C bag temperature in order to start treatment

Maximum Total Volume 30,000 mL

Drain Time 20-59 minutes

Fill Volume 500-4000 mL

Pause Volume 0-4000 mL

Last Fill Volume 0-4000 mL

Pressures Generated -250 mbar to 650 mbar (pressures that can be generated to assist the transfer of dialysate solution to and/or from the peritoneal cavity of the patient)

Therapy

Total Therapy Time 10 minutes to 47 hours, 59 minutes

Number of Fills 1-99 (Exchanges)

Dwell Time Variable from 0 minutes to 9 hours, 59 minutes

Pauses Variable from 0 to 1 less than or equal to # of Fills programmed

Safety Systems

Air Infusion Protection Controlled by software, the cyclor measures air volume in three consecutive strokes coming from source. Any air volume over the set limits (see below) is pumped to drain and M31 (Air Detected in Cassette) warning is displayed.

Air Detector Sensitivity Limits

Fill: air volume coming from heater bag ≥ 3 mL

Drain: air volume coming from patient's abdominal cavity ≥ 3 mL

Dwell: If air volume coming from supply bag ≥ 6 mL

Dialysate Solution Overfill Protection Controlled by software. Drain bypass is prevented when overfill is 1.5 or 150% of prescribed fill (150% = next fill + amount of previous fill not yet drained)

Over Temperature Protection Over temperature protected by two thermostats opening at $104^{\circ} \pm 4^{\circ}\text{F}$ and $120^{\circ} \pm 4^{\circ}\text{F}$

Options

Add diurnal UF	Last bag option	Drain exit %
Language	SI Units	Personal data
USB enabled	Add. drain	Add. drain alert
Flow alert	Flow alert sound	

Accessories

IQdrive (P/N 180202)

Liberty Cart (P/N 180080)

Modem Model MTC-LAT1-B01-US (P/N PK-230)
FCC Part 15 Class B
FCC Part 22, 24, 27
Safety Approval: UL/cUL 60950-1, IEC60950-1

Modem Model MTC-LVW2-B01-US (P/N PK-232)
FCC Part 15 Class B
FCC Part 22, 24, 27
Safety Approval: UL 60950-1, IEC60950-1

Gateway Model SL-06-FS2 (P/N PK-244)
FCC Part 15 Class B
Colocation – FCC 15.247 (Part 15 Subpart C)
Safety Approval: IEC 60950-1, IEC 60601-1-2, 4th edition, IP22 operation

Gateway Model SL-06-FS3 (P/N PK-245)
FCC Part 15 Class B
Colocation – FCC 15.247 (Part 15 Subpart C)
Safety Approval: IEC 60950-1, IEC 60601-1-2, 4th edition, IP22 operation



MEDICAL EQUIPMENT
WITH RESPECT TO ELECTRICAL SHOCK, FIRE AND MECHANICAL HAZARDS ONLY
IN ACCORDANCE WITH UL 60601-1 and IEC 60601-2-39
CAN/CSA – C22.2 No. 601
CAN/CSA – C22.2 No. 601.2.39
Control No. 36CT

Manufacturer's EMC Declaration

The Liberty Cyclor has been certified to the requirements of ANSI/AAMI/IEC 60601-1-2:2007 within the scope of equipment intended to be used in the home and institutional environments, such as hospitals.

Emissions testing of the machine was performed using the limits for CISPR 11 Group 1, Class B which are specified for equipment intended to be used in homes. However, use of the Liberty Cyclor in residential environments may result in interference with some types of broadcast receivers such as televisions and radios. Should such interference occur, it will not permanently affect those receivers and can be reduced or eliminated by repositioning of the receiver or the Liberty Cyclor.

In order to assure the safety of the Liberty Cyclor as well as other medical devices when used with the Liberty Cyclor in the home environment, a detailed technical analysis was performed. This analysis has shown that the emissions levels of the Liberty Cyclor are significantly below the immunity requirements of ANSI/AAMI/IEC 60601-1-2 and therefore are not likely to impact the safe operation of other medical devices used within the proximity.

Guidance and manufacturer's declaration – electromagnetic emissions		
The Liberty Cyclor is intended for use in the electromagnetic environment specified below. The customer or user of the Liberty Cyclor should ensure it is used in such an environment.		
Emissions test	Compliance	Electromagnetic environment – guidance
RF Emissions CISPR 11	Group 1	The Liberty Cyclor uses RF energy only for its internal functions. Therefore, its RF emissions are very low and are not likely to cause any interference in nearby electronic equipment.
RF Emissions CISPR 11	Class B	The Liberty Cyclor is suitable for use in all establishments including domestic, and those directly connected to the public low-voltage power supply network that supplies buildings used for domestic purposes.
Harmonic emissions IEC 61000-3-2	Class A	
Voltage fluctuations/ flicker emissions IEC 61000-3-3	Complies	

Guidance and manufacturer's declaration – electromagnetic immunity			
The Liberty Cycler is intended for use in the electromagnetic environment specified below. The customer or the user of the Liberty Cycler should assure that it is used in such an environment.			
Immunity test	IEC 60601 test level	Compliance level	Electromagnetic environment – guidance
Electrostatic discharge (ESD) IEC 61000-4-2	±6 kV contact ±8 kV air	±6 kV contact ±8 kV air	Floors should be wood, concrete, or ceramic tile. If floors are covered with synthetic material, the relative humidity should be at least 30%.
Electrical fast transient/burst IEC 61000-4-4	±2 kV for power supply lines ±1 kV for input/output lines	±2 kV for power supply lines ±1 kV for input/output lines	Mains power quality should be that of a typical low-voltage power supply network that supplies hospitals or buildings used for commercial or domestic purposes.
Surge IEC 61000-4-5	±1 kV line(s) to line(s) ±2 kV line(s) to earth	±1 kV line(s) to line(s) ±2 kV line(s) to earth	Mains power quality should be that of a typical low-voltage power supply network that supplies hospitals or buildings used for commercial or domestic purposes.
Voltage Dips, short interruptions, and voltage variation on power supply input lines IEC 61000-4-11	<5 % U_T (>95 % dip in U_T) for 0.5 cycles 40 % U_T (60 % dip in U_T) for 5 cycles 70 % U_T (30 % dip in U_T) for 25 cycles <5 % U_T (>95 % dip in U_T) for 5 seconds	<5 % U_T (>95 % dip in U_T) for 0.5 cycles 40 % U_T (60 % dip in U_T) for 5 cycles 70 % U_T (30 % dip in U_T) for 25 cycles <5 % U_T (>95 % dip in U_T) for 5 seconds	Mains power quality should be that of a typical commercial or hospital environment. If the user of the Liberty Cycler requires continued operation during power mains interruptions, it is recommended that the Liberty Cycler be powered from a medical grade uninterruptible power supply.
Power-Frequency (50/60 Hz) magnetic field IEC 61000-4-8	3 A/m	3 A/m	Power frequency magnetic fields should be at levels characteristic of a typical public low-voltage power supply network that supplies hospitals or buildings used for commercial or domestic purposes.
NOTE U_T is the a.c. mains voltage prior to application of the test level.			

Guidance and manufacturer's declaration – electromagnetic immunity

The Liberty Cyclor is intended for use in the electromagnetic environment specified below. The customer or the user of the Liberty Cyclor should assure that it is used in such an environment.

Immunity test	IEC 60601 test level	Compliance level	Electromagnetic environment – guidance
<p>Conducted RF IEC 61000-4-6</p> <p>Radiated RF IEC 61000-4-3</p>	<p>3 Vrms 150 kHz to 80 MHz</p> <p>3 V/m 80 MHz to 2.5 GHz</p>	<p>3 Vrms 150 kHz to 80 MHz</p> <p>3 V/m 80 MHz to 2.5 GHz</p>	<p>Portable and mobile RF communications equipment should be used no closer to any part of the Liberty Cyclor, including cables, than the recommended separation distance calculated from the equation applicable to the frequency of the transmitter.</p> <p>Recommended separation distance</p> <p>$d = 1.2 \sqrt{P}$</p> <p>$d = 1.2 \sqrt{P}$ 80 MHz to 800 MHz</p> <p>$d = 2.3 \sqrt{P}$ 800 MHz to 2.5 GHz</p> <p>where P is the maximum output power rating of the transmitter in watts (W) according to the transmitter manufacturer and d is the recommended separation distance in meters (m).</p> <p>Field strengths from fixed RF transmitters, as determined by an electromagnetic site survey,^a should be less than the compliance level in each frequency range.^b</p> <p>Interference may occur in the vicinity of equipment marked with the following symbol: </p>

NOTE 1 At 80 MHz and 800 MHz, the higher frequency applies.

NOTE 2 These guidelines may not apply in all situations. Electromagnetic propagation is affected by absorption and reflection from structures, objects, and people.

^a Field strengths from fixed transmitters, such as base stations for radio (cellular/cordless) telephones and land mobile radios, amateur radio, AM and FM radio broadcast and TV broadcast cannot be predicted theoretically with accuracy. To assess the electromagnetic environment due to fixed RF transmitters, an electromagnetic site survey should be considered. If the measured field strength in the location in which the Liberty Cyclor is used exceeds the applicable RF compliance level above, the Liberty Cyclor should be observed to verify normal operation. If abnormal performance is observed, additional measures may be necessary, such as re-orienting or relocating the Liberty Cyclor.

^b Over the frequency range 150 kHz to 80 MHz, field strengths should be less than 3 V/m.

**Recommended separation distances between
portable and mobile RF communications equipment and the Liberty Cyclor**

The Liberty Cyclor is intended for use in an electromagnetic environment in which radiated RF disturbances are controlled. The customer or the user of the Liberty Cyclor can help prevent electromagnetic interference by maintaining a minimum distance between portable and mobile RF communications equipment (transmitters) and the Liberty Cyclor as recommended below, according to the maximum output power of the communications equipment.

Rated maximum output power of transmitter (Watts)	Separation distance according to frequency of transmitter (meters)		
	150 kHz to 80 MHz $d = 1.2 \sqrt{P}$	80 MHz to 800 MHz $d = 1.2 \sqrt{P}$	800 MHz to 2.5 GHz $d = 2.3 \sqrt{P}$
0.01	0.12	0.12	0.23
0.1	0.38	0.38	0.73
1	1.2	1.2	2.3
10	3.8	3.8	7.3
100	12	12	23

For transmitters rated at a maximum output power not listed above, the recommended separation distance d in meters (m) can be estimated using the equation applicable to the frequency of the transmitter, where P is the maximum output power rating of the transmitter in watts (W) according to the transmitter manufacturer.

NOTE 1 At 80 MHz and 800 MHz, the separation distance for the higher frequency applies.

NOTE 2 These guidelines may not apply in all situations. Electromagnetic propagation is affected by absorption and reflection from structures, objects, and people.



Caution: In order to prevent potentially hazardous conditions and ensure the safe operation of the Liberty Select Cyclor, Radio Frequency Identification (RFID) Equipment must be kept at least 3 meters from the system while in operation.

Product Improvement Policy

Your Liberty Select Cyclers machine was designed and built to comply with these product specifications. It is the intention of Fresenius Medical Care to continuously improve products, a process that may result in modifications to specifications or equipment produced in the future. Such product improvements shall not incur any obligation to make similar changes or improvements to equipment previously produced. Where possible, improvements will be made available at reasonable prices. Any such improvement shall not be construed as corrections of any deficiency in previously produced equipment.

Warranty

REFURBISHMENT POLICY

It is the policy of Fresenius USA, Inc. to refurbish medical devices so that they meet the same performance specification as new products. Controlled procedures are used and the refurbishment is carried out at the same manufacturing location under the same quality management system as new medical devices.

REPLACEMENT

Fresenius USA, Inc. sells both new and/ or refurbished medical devices. Refurbished medical devices meet the same performance specification as new medical devices (see above) and either may be supplied by the company as warranty replacements.

PERITONEAL CYCLERS

Liberty® Select Cyclers that are rented or leased may be either new or refurbished units. History files on new and refurbished medical devices are maintained by Fresenius USA, Inc. at its Concord, CA manufacturing facility.

Preventive maintenance of peritoneal cyclers is not required. Service is performed at the factory only. Cyclers requiring service or investigation are replaced, generally with refurbished equipment, so that investigation and/or service can be performed at the factory. No user service records are required.

In cases where the Liberty Select Cyclor is sold, SALE of the machine or parts described or referenced herein is expressly conditioned upon the terms and conditions set forth below. Any additional or different terms or conditions set forth by the Purchaser to Fresenius Medical Care, Inc., (herein called “the Company”) shall not be effective or binding, and the terms set forth herein shall not be modified or amended, unless assented to in writing by an authorized official of the Company located in Waltham, Massachusetts.

LIMITED WARRANTY: *The Company warrants to the Purchaser that the equipment delivered is free from defects in material or workmanship for the periods specified below, provided the equipment is used and maintained in accordance with the original manufacturer’s operating instructions:*

A. Mainframe chassis, and electronic components, lamps, etc. shall be warranted for ninety (90) days from the date of initial installation or one hundred and eighty (180) days from the shipment, whichever occurs first.

B. Consumables shall not be warranted.

*The Company will repair or replace, at its option, using new or reconditioned parts and/or assemblies, any parts subject to this warranty which are proven defective in materials or workmanship. Such repair and replacement will be made without cost to the Purchaser, and the Company reserves the right to determine the location at which the repair or replacement will be accomplished. The Warranty does not apply to any equipment which is misused, abused, neglected, tampered with, damaged by accident, flood, fire, or other hazard, subjected to abnormal or unusual electric or fluid stress, improperly installed or operated, or not maintained in accordance with the routine maintenance schedule set forth in the operating manual for the equipment. **Routine maintenance is not covered under warranty.** Modifications, alterations, installation, and service by other than a FRESENIUS MEDICAL CARE authorized representative may void the warranty.*

WARRANTIES APPLICABLE TO EQUIPMENT EXTEND ONLY TO THE PURCHASER, AND ARE NOT ASSIGNABLE OR TRANSFERABLE, AND SHALL NOT APPLY TO AUXILIARY EQUIPMENT, DISPOSABLE ACCESSORIES, OR LIGHT SOURCES. THE FOREGOING WARRANTY SHALL BE IN LIEU OF ANY OTHER WARRANTIES, EXPRESSED, IMPLIED, OR STATUTORY, RESPECTING THE EQUIPMENT OR ANY PARTS OR COMPONENTS THEREOF, AND THE COMPANY MAKES NO IMPLIED WARRANTY OF MERCHANTABILITY OR FITNESS FOR A PARTICULAR PURPOSE. THE PURCHASER'S SOLE AND EXCLUSIVE REMEDY IN CONTRACT, TORT, OR UNDER ANY OTHER THEORY AGAINST THE COMPANY RESPECTING THE EQUIPMENT AND ITS USE SHALL BE THE REPLACEMENT OR REPAIR OF THE EQUIPMENT AND ITS PARTS AS DESCRIBED ABOVE, AND NO OTHER REMEDY (INCLUDING, WITHOUT LIMITATION, CONSEQUENTIAL DAMAGES) SHALL BE AVAILABLE TO THE PURCHASER. The Company shall have no further obligation or liability with respect to the equipment or its sale, operation and use, and the Company neither assumes, nor authorizes the assumption of, any obligation or liability in connection with such equipment.

TERMS: *Net 30 days, FOB shipping point plus sales and similar taxes. The Company's prices do not include sales, use, excise, or similar taxes. Consequently, in addition to the prices specified herein, the amount of any present or future sales, use, excise, or other similar tax applicable to the or use of the equipment hereunder shall be paid by the Purchaser, or in lieu thereof, the Purchaser shall provide the Company with a tax exemption certificate acceptable to the taxing authorities. Purchase price will include operation training of Purchaser's personnel when a complete system is purchased. Installation for replacement parts will be charged to the Purchaser on a time, material, and expense basis unless covered under the limited warranty or a service contract.*

SHIPPING: *The Company will use its own judgment in determining the most effective method of shipping unless otherwise specified by the purchaser.*

For additional servicing and information contact:

Fresenius Medical Care (800) 227-2572

Attention: Service Department

4040 Nelson Ave

Concord, CA 94520

The Liberty Select Cyclor is manufactured by:

Fresenius USA, Inc.

4040 Nelson Ave

Concord, CA 94520

Glossary

Abdomen—Area of your body below the chest and above the hips, also called the belly.

Additional Drain—An optional drain at the end of treatment that is planned ahead of time.

Ambulatory—Moving or walking around.

APD—Abbreviation for Automated Peritoneal Dialysis, the use of a machine for peritoneal dialysis.

Aseptic Technique—A series of steps used to keep an area as germ free as possible, including putting on a mask, thoroughly washing and drying your hands, and remembering which parts of your supplies are sterile.

Button—Certain identified sites on the Touch Screen that, when touched, will cause a specific action.

CAPD—Abbreviation for ‘Continuous Ambulatory Peritoneal Dialysis.’ CAPD requires a manual exchange.

CCPD—Abbreviation for ‘Continuous Cycling Peritoneal Dialysis.’ CCPD is a continuous therapy with exchanges occurring throughout the night and

sometimes during the day. CCPD requires a cycler.

CCPD Volume—The amount of dialysate delivered during exchanges.

Clean—You have removed most, but not all of the germs. Good hand washing makes your hands clean, not sterile. Your work surface is clean, not sterile.

Cone—Plug at the inside end of a dialysate solution bag. Breaking the cone opens the bag and allows the flow of solution to the connected tubing.

CRC—Abbreviation for Cyclic Redundancy Check. CRC is an error-detecting code used to check the integrity of the data.

Dextrose (Glucose)—A form of sugar used in dialysate to remove fluid.

Diastolic Pressure—The lower blood pressure number, it describes the blood’s pressure on arteries just before the next heartbeat.

Dialysate—Dialysis solution used to clear waste fluid from your body.

Diurnal—Daytime, opposite of nocturnal.

Drain—Process of emptying your peritoneal cavity of dialysate which carries waste and fluid out of the body.

Drain Exit %—The minimum volume requirement for completing a drain.

Drain Time—The amount of time available to drain your peritoneal cavity of used dialysate.

Dry Day—Term for having very little fluid left in your abdomen as a result of no programmed Last Fill for your treatment.

Dwell—Stage of peritoneal dialysis treatment in which the dialysate remains in your peritoneal cavity for a specified amount of time. The dwell time is the time allowed for actual dialysis to take place during each exchange.

Effluent—The used dialysate that your cyclor drains out of you.

ESRD—Abbreviation for ‘End Stage Renal Disease.’

Exchange—Act of replacing the dialysate in your peritoneal cavity. An exchange or cycle consists of three steps: Fill, Dwell, and Drain.

Fibrin—White protein strands that are sometimes found in your drained dialysate.

Flush—Procedure to remove air and potential contaminants from bag line and connections.

Fill—Process of filling your peritoneal cavity with fresh dialysate.

Fill Volume—The prescribed amount of dialysate to fill your peritoneal cavity during an exchange.

Fill Time—The amount of time available to fill your peritoneal cavity with fresh dialysate.

Flow Alert— An optional series of self-resetting notification that alerts in the form of four soft beeps and an on-screen message. It can occur during Drain and Fill phases if you are not draining or filling as expected.

Increased Intraperitoneal Volume (IIPV)—see *Overfill*

IPD—Abbreviation for ‘Intermittent Peritoneal Dialysis.’ Exchanges usually take place at night with a dry day.

Keys—Located on the Control Panel, keys work outside the Touch Screen to scroll, confirm selections, and stop functions.

Last Fill Volume—The amount of dialysate left in your peritoneal cavity before disconnecting from your machine.

MR— Refers to MRI, Magnetic Resonance Imaging.

Overfill—Also known as Increased intraperitoneal volume (IIPV) is when you have too much fluid in your abdomen. IIPV/overfill may result in serious injury or death from conditions such as: abdominal wall and/or diaphragmatic hernias, hydrothorax, heart problems including chest pain and heart failure, high blood pressure, pulmonary edema, decreased pulmonary function and pericardial effusion. Patients and care partners should watch for the potential signs of IIPV. These include: difficulty breathing; vomiting or spitting up; feeling full, bloated, or overfilled after treatment; abdominal pain or discomfort; expanded or tense abdomen; chest pain, increased blood pressure, change in mental status, and leakage of fluid from the PD catheter exit site.

Parameter-Button—A button on the Touch Screen that displays the changeable value it controls.

Pause—An exchange that allows you to dwell while either connected to or disconnected from your cyclor. It differs from other Dwells because it is not a

timed function, meaning you may pause for as long as you like.

Pause Volume—The amount of dialysate delivered during the Pause portion of the exchanges.

PD—Abbreviation for ‘Peritoneal Dialysis.’

PD+—Abbreviation for ‘Peritoneal Dialysis Plus,’ a therapy that features pauses prior to nighttime therapy. See *Pause* for more information.

Peritoneal Cavity—Area of your body containing your stomach, liver, intestines, spleen, and pancreas. See also *Abdomen*.

Peritoneal Dialysis—The procedure carried out by your body that pulls the waste products and excess water from your blood stream.

Peritoneum—Smooth semi-permeable membrane which lines the cavity of the abdomen covering internal organs.

Pneumatic Pressure — Compressed air used by the cyclor during its operation.

Prime—Procedure to remove air from the tubing line that connects to the patient’s catheter extension set.

Screen-button—Any of the buttons located in the Status Bar on the Touch Screen. Touching one of these buttons will display its screen.

SI units—Abbreviation for ‘System, International.’ This is a set of measuring standards that uses the metric system including kilograms (kg), Celsius degrees (°C), and millimole per liter (mmol/L). The Liberty Select Cyclor can display values in either SI units or US standard units (lbs., °F, or mg/dL).

STAT drain—An unplanned drain initiated by the user.

Status Bar—Top section of the Touch Screen that shows your machine’s operational mode. It is color coded to show your machine’s status. The Status Bar also alerts the operator to any warning or alarm event.

Sterile—Sterile means completely free of germs. Some of the supplies are packaged to keep them sterile. Some parts of the supplies must remain sterile after opening the package.

Systolic pressure—The higher blood pressure number, it is the blood’s pressure on arteries during a heartbeat.

Thermistor— A type of temperature sensor that is used to measure temperature.

Tidal fill volume—The amount of dialysate to fill your peritoneal cavity during a Tidal therapy exchange. This amount is typically less than CCPD and IPD volumes.

Tidal drain volume—The amount of dialysate that is drained during each Tidal Exchange. Drain 0 and the last Drain of the treatment will drain completely.

TPD—Abbreviation for ‘Tidal Peritoneal Dialysis.’

Total sleep time/Total therapy time—The estimated sum of all Drain, Fill, and Dwell time during a treatment.

Total Volume—The total amount of dialysate you need for your treatment.

UF—Abbreviation for ‘Ultrafiltration.’

Ultrafiltration—Ultrafiltration is the process of drawing off excess fluid from the bloodstream during treatment.

Unrecoverable Error—Alarms in which the Liberty Select Cyclor Display Status Bar turns red and cannot be resolved; contact a Fresenius Medical Care Technical Support Representative at **1-800-227-2572**.

Urea—Dissolved protein waste product.

USB—Abbreviation for ‘Universal Serial Bus.’ This is a type of connection used to transfer data. The IQdrive connects to the USB port on the back of your Liberty Select Cyclor.

Index

- #**
- # Fills 59, 63, 67, 73
- A**
- Add diurnal UF 87
- Additional drain..... 91
 - Alert 91
- Alarm loudness..... 95
- Alarms 208, 209, 216, *See Error messages*
 - No sound (Inaudible) 207
- B**
- B (treatment details) 165
- Bag *See Solution bag*
- Bag sensor 45
- Balloon Valve .. 222, 227, 235, 236
- Birth date *See Date of birth*
- Blood glucose 159, 181
- Blood pressure 159, 181
- Brightness setting 95
- Button Area 27
- Buttons
 - Description..... 31
 - Details..... 31, 163
 - Hardware 94
 - Help 213, 245
 - Movement-buttons..... 31
 - My Records 33, 177
 - My Settings..... 33, 53
 - My Treatment 33, 101
 - Options 86, 90
 - Parameter-buttons..... 31
 - Patient 76
 - Screen-buttons 31, 32
 - Therapy 54
- Bypass..... 187
- C**
- Cassette
 - Catch 35
 - Description..... 39
 - Door..... 36
 - Guide pins 35
 - Inserting..... 104, 106, 107
 - Inspecting 105
 - Leak..... 169
- Pump plate..... 35
- Removal..... 166, 168, 169
- Catheter Line *See Lines*
- CCPD.....*See Continuous Cycling Peritoneal Dialysis*
- CCPD Cycle-Based Settings 58
- CCPD Treatment-Based Settings56
- Cleaning..... 248
- Clock 95
- Codes . *See Error messages, Listed by code*
- Connecting132, 133, 142, 146, 147
- Connector143, 155, 209, 217, 219, 243, 245, *See stay•safe connector*
- Continuous Cycling Peritoneal Dialysis..... 137
- Control Panel 26
- CRC Alarm..... 210, 229, 230
- Cycle based *See Therapy*
- D**
- Date 95
- Date format 95
- Date of birth, entering 80
- Daytime manual exchange 128
- Details button *See Buttons*
- Dextrose 159, 181
- Diastolic 159
- Disconnect 154
- Door latch 36
- Door Latch 36
- Door sensor 35
- Door, Cassette 36
- Drain 137, 138, 240
- Drain 0 133, 139, 187
- Drain complication 231
- Drain exit % 91
- Drain line..... *See Lines, Drain*
- Drain time 59, 63, 67, 73
- Dwell 137, 148
- Dwell time 59, 63, 67, 73
- E**
- Electrical plug 47
- Electromagnetic
 - Emissions..... 254
 - Environment..... 254
 - Immunity 254

Error messages	
Listed alphabetically.....	230
Listed by code.....	221
Exchange	137
Extension cap holder	See Stay•safe

F

F (treatment details).....	165
Fill	137, 140
Fill time.....	59, 63, 67, 73
Fill volume.....	59
First Name, entering	76
Flushing	120

G

Gender, entering.....	84
General warnings.....	17
Glucose.....	See Blood glucose
Green line	See Lines, Last

H

Hardware button	See Buttons
Heater bag	
<i>Not detected</i>	232
Placement	110, 112
Heater line.....	See Lines
Heater tray	44
Help button.....	See Buttons, See Buttons
Help screens	214

I

ID, entering	79
IIPV	See Overfill
Inaudible Alarms	See Alarms
Incomplete treatment	17
Intermittent Peritoneal Dialysis	137
IPD	See Intermittent Peritoneal Dialysis
IPD Cycle-Based Settings.....	62
IPD Treatment-Based Settings ..	60
IQdrive	195, 197
Accept settings.....	197
Handling	171
Inserting	195
Reject settings	197

K

Key loudness	95
Keys	
OK key	27
STOP key.....	27
Up/Down Arrow keys.....	27

L

Language setting.....	87
Last bag option.....	87
Last bag type.....	159, 181
Last line	See Lines
Leak.....	105, See Cassette
Transdiaphragmatic.....	13
Liberty Select Cyclor	
Features	23
Powering up	50
Requirements	12
Servicing.....	1, 261
Setting up	46
Lines	
Blockage.....	231, 233, 234, 238
Catheter Line	39
Connect	110, 112
Drain	40, 114, 167
Heater.....	40
Last.....	39
Patient	39, 133, 234
Solution	40, 113

M

Machine specifications	250
Main Area	27
Manual exchange	128
Mask.....	105, 147
Messages	See Error Messages
Movement-Buttons	See Buttons
My Records screen-button	33, 176
My Settings screen-button...	33, 53
My Treatment screen-button	33, 101
My Treatment Settings	6

N

Name, entering.....	79
New cap holder	See stay•safe

O

OK key.....	See Keys
Options button ...	See Buttons, See Buttons
Options settings.....	86, 90
Organizer.....	See Stay•safe
Overfill	14, 19, 133, 139, 187

P

P (treatment details).....	165
Parameter-Buttons	See Buttons
Patient button	See Buttons
Patient line.....	See Lines
Patient line (extended)	127
Patient settings.....	76

Pause	137
Disconnect.....	142
Reconnect	146
PD+ Cycle-Based Settings	66
PD+ Treatment-Based Settings.	64
Peritoneal Dialysis	
Contraindications.....	13
Indications	12
Side Effects	13
Personal Data.....	180
Personal data option	87
Pinch Hazard.....	17, 36, 108
Power cord	47
Power down cyler	170
Power failure	242
Pressure sensor	35
Prime	125
Priming	122
Product improvement policy	258
Program mode.....	55
Pulse	159, 181
Pump heads	34
Pump module	34
Pump Module	
Moisture.....	169
Pump plate	35

R

Recovery failure	245
Red line	See Lines, Heater

S

S (treatment details)	165
Safety clamp.....	35
Screen blanking.....	95
Screen-Buttons.....	See Buttons
SI units	87
Solution bag	
Bag sizes	45, 251
Connect	110, 112
Detection	119
Placement.....	111
Solution line.....	See Lines
STAT drain	155, 185
Status Bar	
Alarm	210
Description.....	28
Warnings	207
Stay•safe	
Cleaning	249
Connector.....	39
Extension cap holder	43
New cap holder.....	43
Organizer clip	43
Setting up	109, 132, 146

Tubing channel	43
STOP key	See Keys, STOP
Systolic	159

T

Technical Support.....	16
Temperature	159, 181
Therapy	
Cycle based	55
Treatment based.....	55
Therapy button.....	See Buttons
Therapy type.....	55
Tidal Cycle-Based Settings.....	72
Tidal Treatment-Based Settings	68
Time	
Format.....	95
Setting.....	95
Touch Screen	
Buttons.....	30
Description	27
Treatment	
End.....	169
Summary.....	162
Treatment Alarm.....	210, 222, 223, 224, 227, 228, 238, 239
Treatment based.....	See Therapy
Tubing channel	See stay•safe
Tubing organizer	39
Tubing set	
Damage	17, 105
Description	See Cassette
Placement.....	See Stay•safe
Tubing Set	
Inserting See Cassette, Inserting	
Inspecting.....	See Cassette, Inspecting

U

Units setting	87
Unrecoverable Error.....	221, 222, 223, 224, 227, 228, 229, 238, 239
Up/Down Arrow keys	See Keys
USB enabled option	195
USB Port.....	195
USB Upload	197

V

Valves	35
Volume (sound)	95

W

Warnings.....	206, 207, 212, See Error messages
Warranty	258
Weight	

After treatment 159, 181
Entering 82
White line See Lines, Solution

Y

Yellow line See Lines, Drain

www.fmcna.com



Fresenius USA, Inc. | 4040 Nelson Avenue | Concord, CA 94520