

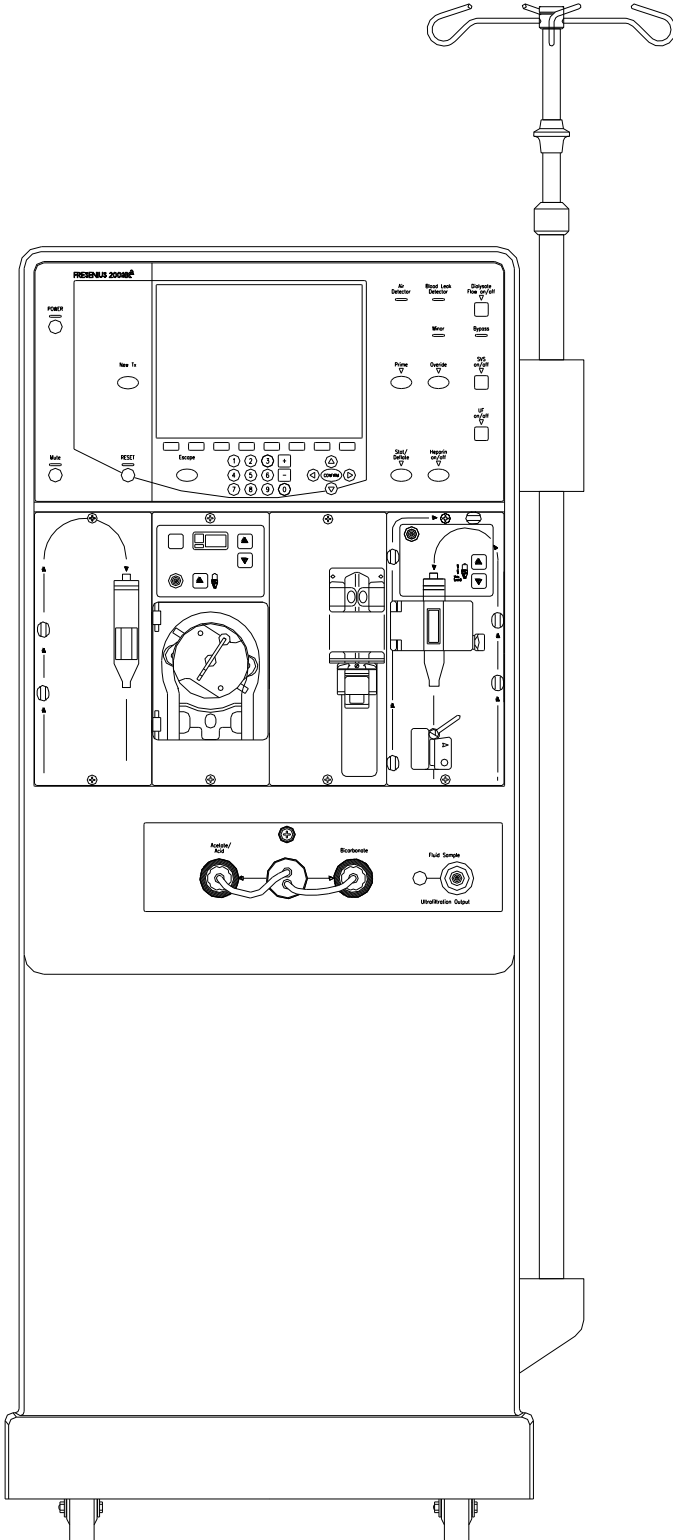

**FRESENIUS
MEDICAL CARE**



**2008K²
HEMODIALYSIS
SYSTEM
CALIBRATION
PROCEDURES**

Part Number 508137 Rev. F

FRESENIUS MEDICAL CARE NORTH AMERICA

800-227-2572

**Fresenius Medical Care North America
920 Winter St.
Waltham, MA 02451**

**Manufactured by:
Fresenius USA, Inc.
4040 Nelson Avenue
Concord, CA 94520**

REGIONAL EQUIPMENT SPECIALIST: _____

2008K²
HEMODIALYSIS SYSTEM

CALIBRATION
PROCEDURES

Part Number 508137 Rev. F

<http://www.fmcna.com>

Copyright © 2008 - 2015 Fresenius Medical Care North America, All Rights Reserved

2008K² Calibration Procedures

This document contains proprietary information of Fresenius USA, Inc. d/b/a Fresenius Medical Care North America and its affiliates (“Fresenius Medical Care”). The contents of this document may not be disclosed to third parties, copied, or duplicated in any form, in whole or in part, without the prior written permission of Fresenius Medical Care.

Fresenius Medical Care, the triangle logo, 2008K², 2008, and DIASAFE are trademarks of Fresenius Medical Care Holdings, Inc., and/or its affiliated companies. All other trademarks are the property of their respective owners.





Caution: US Federal law restricts this device to sale only by or on the order of a physician. Frequency, duration, and parameters of treatment are to be determined by the prescribing physician.

Installation, maintenance, calibration and other technical information may be found in the 2008K² Technician’s Manual, P/N 490137.

Contact Fresenius Medical Care Technical Support for applicable Field Service Bulletins. The spare parts manual for the model 2008K² and other information may be found on our web site at www.fmcna.com

Indications for Use: The 2008K² hemodialysis machine is indicated for acute and chronic dialysis therapy.

Conventions

Symbol	Description
	Warning! A warning is a statement that identifies conditions or actions that could result in personal injury or loss of life. Warnings found in this manual outside of this section are designated with the warning symbol.
	Shock Hazard: A shock hazard warning refers to a risk of a possibly severe electrical shock due to improper use or handling of the equipment.
	Caution: A caution is a statement that identifies conditions or actions that could result in damage to the machine.
	Note: Notes are advisory comments or recommendations regarding practices or procedures.

CALIBRATION PROCEDURES

TABLE OF CONTENTS

1.0 INTRODUCTION	1
1.1 TEST EQUIPMENT AND SUPPLIES NEEDED	2
1.2 OPERATING MODES	3
1.3 FRONT PANEL CONTROLS	6
1.4 MEASURING FLUID VOLUMES.....	9
1.5 CALIBRATE IF REPLACED.....	10
2.0 SERVICE MODE CALIBRATIONS	11
2.1 HYDRAULIC CALIBRATION PROCEDURES	12
2.1.1 DEAERATION AND LOADING PRESSURE CALIBRATION	13
2.1.2 FLOW PRESSURE CALIBRATION.....	16
2.1.3 BALANCE CHAMBER VOLUME CALIBRATION	17
2.1.4 ACID (CONCENTRATE) PUMP VOLUME CALIBRATION	19
2.1.5 BICARBONATE PUMP VOLUME CALIBRATION	21
2.1.6 UF PUMP VOLUME CALIBRATION.....	23
2.2 SENSOR CALIBRATION PROCEDURES	26
2.2.1 ARTERIAL PRESSURE CALIBRATION.....	27
2.2.2 VENOUS PRESSURE CALIBRATION	33
2.2.3 DIALYSATE PRESSURE CALIBRATION	36
2.2.4 TEMPERATURE SENSOR CALIBRATION.....	38
2.2.5 POST TEMPERATURE SENSOR CALIBRATION	40
2.2.6 TEMPERATURE CONTROL CALIBRATION	42
2.2.6.1 TEMPERATURE CONTROL CALIBRATION (METHOD 1)	43
2.2.6.2 TEMPERATURE CONTROL CALIBRATION (METHOD 2)	46
2.2.6.3 TEMPERATURE CONTROL CALIBRATION (METHOD 3)	50
2.2.6.4 TEMPERATURE CONTROL CALIBRATION (METHOD 4)	53
2.2.7 BLOOD LEAK CALIBRATION	56
2.2.8 CONDUCTIVITY CELLS CALIBRATION.....	58
2.3 MONITOR CALIBRATION PROCEDURES	61
2.3.1 SET CLOCK	62
2.3.2 VOLTAGE DETECTION CALIBRATION	63
2.3.3 ARTERIAL PUMP RATE	66
2.3.4 VENOUS PUMP RATE.....	67
3.0 CALIBRATION PROCEDURES NOT PERFORMED IN SERVICE MODE	68
3.1 INLET WATER PRESSURE REGULATOR CALIBRATION	68
3.2 LEVEL DETECTOR CALIBRATION	70
3.3 BLOOD PUMP CALIBRATION	72

General Warnings



Warning! Never perform maintenance when a patient is connected to the machine. If possible, remove the machine from the treatment area when it is being serviced. Label the machine to ensure it is not accidentally returned to clinical use before the service work is completed. Always fully test the machine when maintenance is completed. Confirm dialysate conductivity and pH level before returning the machine to clinical use.



Shock Hazard: Refer servicing to qualified personnel.

The electrical source must be 120 volts, 60 Hz, single phase. The outlet must be a three-conductor type with a hospital-grade receptacle and a ground fault interrupter. Test the polarity and ground integrity before installation and ensure it is maintained thereafter. Failure to do so may result in electrical shock to the operator or patient



Warning! Calibration procedures must be performed using primary standards or by using standards that are regularly calibrated in a program traceable to the National Institute of Standards and Technology (National Bureau of Standards)



Warning! Calibrate the Level Detector module for the model of venous line being used. During calibration ensure the filter inside the drip chamber is below the sensor heads. Also verify that the venous clamp fully occludes the line when closed



Warning! Failure to install, operate and maintain this equipment according to the manufacturer's instructions may cause injury or death to the patient or the operator



Warning! Only Original Equipment Manufacturer (OEM) Fresenius Medical Care parts should be used in the repair or upgrade of the Fresenius Medical Care 2008K² Hemodialysis System. Although, parts may look similar to parts in various vendor catalogs or brick and mortar stores the 2008K² Hemodialysis System uses parts that have been specified and tested in accordance to ANSI/AAMI/ISO guidelines. The use of non-OEM parts will void your warranty and may cause patient harm.



Note: This document is written for 2008K² Hemodialysis Systems using software versions 5.10 or later.

1.0 INTRODUCTION

Calibration involves doing two things. One is making mechanical adjustments, both to the hydraulics and to the electronics. The other part of calibration is storing data in the electronic memory in the machine. The machine uses an EEPROM, which stores calibration data until it is purposely erased and replaced with new data. To store new data in the EEPROM, the machine is operated in Service Mode as described in Section 1.2. Service Mode also shows important data that is needed to make some of the mechanical adjustments.

Perform the calibration procedures only when needed following repairs, or if the machine fails the performance tests included in the Preventive Maintenance Procedures. Do not re-calibrate the machine routinely to verify normal operation. Instead, use the performance tests included in the Preventive Maintenance procedures to ensure the machine is working properly.

If the machine behaves erratically during calibration, perform the Preventive Maintenance procedures. Clogged filters, leaky O-rings and similar items routinely corrected during Preventive Maintenance are a common cause of intermittent problems. When preparing to re-calibrate the Blood Leak Detector, either perform a bleach rinse first or verify that it has been done recently. The bleach rinse is required to clean the detector tube.



Warning! Once a chemical rinse is performed, the only selection the machine will allow is a mandatory rinse. This information is stored on the functional board. Therefore, if the functional board and EEPROM are swapped out together when troubleshooting a calibration or machine problem, the machine must be rinsed prior to releasing it back into service.

1.1 TEST EQUIPMENT AND SUPPLIES NEEDED

The following supplies and test equipment are required to perform the calibration procedures.



Warning! Test equipment used must be maintained and/or calibrated per the test equipment manufacturer's requirements. In particular, the dialysate meter must meet the specifications listed below. Refer to the test equipment's operator's manual, or contact the manufacturer for calibration and maintenance requirements. Failure to properly maintain and calibrate test equipment could lead to improper calibration and/or failure of the device to meet its specifications.

- Test Kit (part number 150034), which contains two gauges with fittings and hoses for measuring loading pressure and deaeration pressure.
- Test connectors containing precision resistors that simulate the thermistor resistance at various temperatures (part number 190060).
- Dialysate meter to measure dialysate pressure, temperature and conductivity at the ends of the dialysate lines. The meter must be capable of making pressure measurements of from -250 mmHg to +400 mmHg with an accuracy of at least ± 2 mmHg up to ± 200 mmHg and an accuracy of at least 1% and ± 1 mmHg beyond ± 200 mmHg. The temperature function of this meter must be accurate within 0.2°C from 20°C to 45°C and must be capable of measuring dialysate temperatures up to 85°C with an accuracy of at least $\pm 4.0^{\circ}\text{C}$. The conductivity function of this meter must be accurate to within 0.1 mS over a range of 12 mS to 17 mS at a temperature of 25°C .
- Stopwatch with a resolution to 0.01 second and an accuracy of 0.01% or better.
- Buret, 25ml capacity with 0.1ml graduations (part number 290104).
- Graduated cylinder: 100ml capacity with a tolerance of 0.60ml at 100ml or better.

- Digital Multimeter to measure dc voltage, ac voltage and resistance with an accuracy of at least 1% + 1 digit for dc voltage measurements 1.5% + 5 digits for ac measurements and 1% + 1 digit for resistance measurements.
- Syringe, 60 cc capacity. Tolerance is not important; the syringe is not used for volume measurements.

For machines equipped with the blood pressure module, the following equipment is also required to test the module as described in this manual:

- Test Device (part number 370090). The Test Device contains two air chambers with calibrated volumes.
- Mercury manometer or equivalent pressure meter accurate to within 1 mmHg at pressures up to 335 mmHg.

1.2 **OPERATING MODES**

The following calibration procedures contain instructions to place the 2008K² into Dialysis Mode and Service Mode.

To place the machine in Service Mode, turn the machine power On and wait for the message **Press CONFIRM for Service Mode** to appear. Once it appears, press the [CONFIRM] key and the message will change to **Machine in Service Mode**. After the System Initializing process is complete, the machine will be in Service Mode.

If the [CONFIRM] key is not pressed when the **Press CONFIRM for Service Mode** message is on the screen, the screen will change and the message **Machine in Dialysis Mode** will appear. After the System Initializing process is complete, the machine will be in Dialysis Mode.

Upon power up in Service Mode, the following screen will appear on the front panel display:

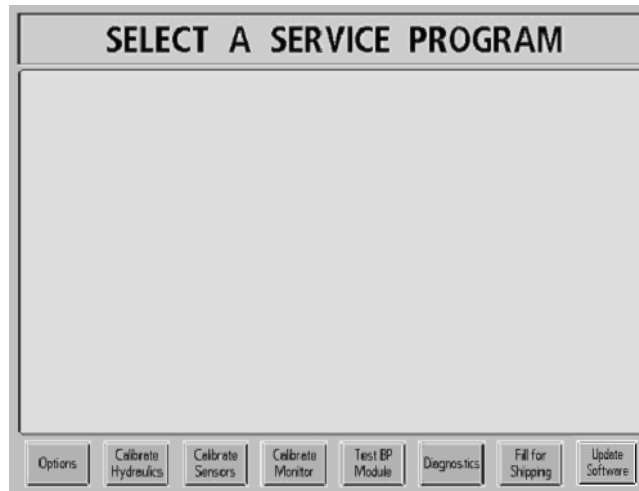

Choose a calibration by selecting¹ the appropriate screen key directly below the calibration button. A second row of buttons will appear above the first.



Note: Calibration procedures that have a red button must be completed before the machine will operate in Dialysis Mode.

Select¹ the desired calibration, then press the [CONFIRM] key to begin the procedure.



Caution: Once a calibration procedure is begun, pressing the [CONFIRM] key usually updates the calibration data in the EEPROM. Be careful not to press the [CONFIRM] key unless you want to change the calibration data. To leave a calibration procedure without changing the data in the EEPROM, press the [Escape] key.

A safety feature in the machine helps prevent mis-calibration. If a calibration value outside of acceptable limits is entered, the machine will reject the calibration data and the message OPERATOR ERROR will appear on the display screen. The data stored in the EEPROM will not be changed if this message appears.

¹ Refer to Section 1.3 on the use of screen buttons.

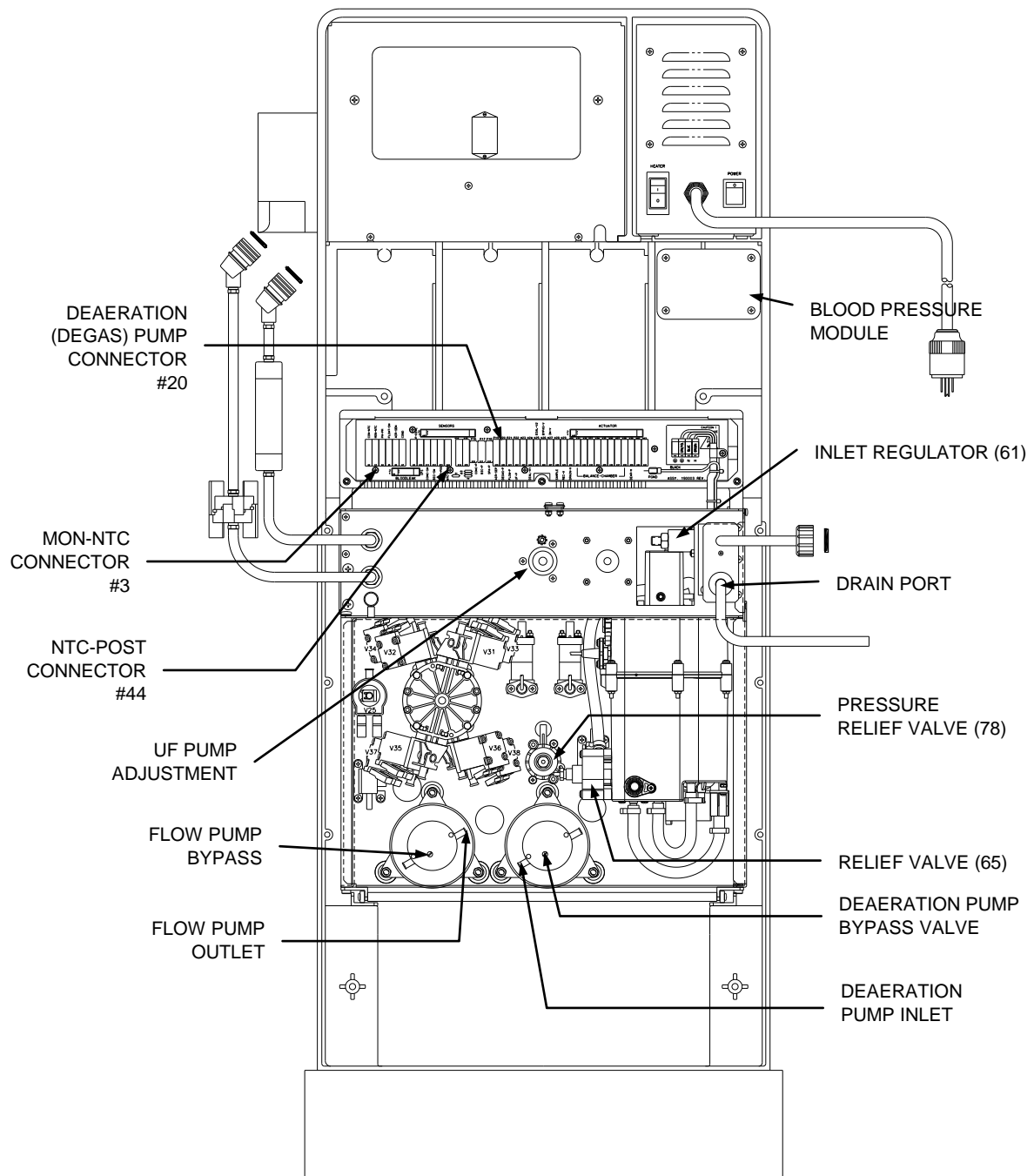

Figure 1 - 2008K² Rear View

1.3 FRONT PANEL CONTROLS

The front panel consists of many areas. The following illustrates these areas:

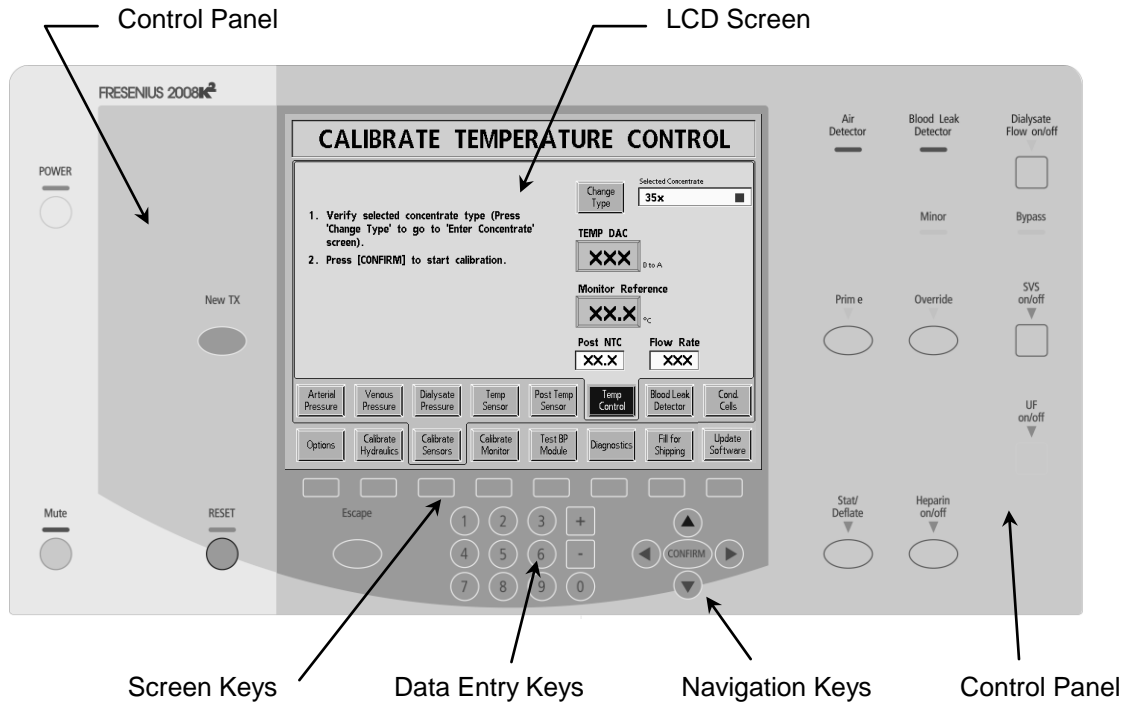

Figure 2 - 2008K² Front Panel

Control Panel Operation

Throughout the calibration procedures, whenever a control panel key is to be pressed, the appropriate key name is surrounded by square brackets as in the following example:

Press the [CONFIRM] key and the screen will change.

In this example, the CONFIRM key on the control panel should be pressed.

Screen Operation

The screen is designed to display information and is used to enter data. The following describes the type of buttons and data boxes that will be encountered during the calibration process.

Data Button

A yellow data button is used during calibration to enter a measured volume or value. When the yellow area of the data button is highlighted and the [CONFIRM] key is pressed, it will change to a darker yellow. The data can be changed using the [+] and [-] data entry keys or the value can be entered using the number keys both on the control panel. Once the data is entered, press the [CONFIRM] key and the data button changes back to light yellow. The [Escape] key can be pressed when the data button is dark yellow to abort the data entry and return it to light yellow. The entered data does not get stored until the [CONFIRM] key is pressed.

A gray data button means the button is not active.



Screen Button (screen key)

The bottom row of blue screen buttons are selected by pressing the corresponding screen key directly below the screen button. By pressing a screen key, the screen will change to the selected screen directly without pressing the [CONFIRM] key. If data entry, option change, or menu selection is in process when a screen key is pressed, a message requiring the operator to press the [Escape] key or the [CONFIRM] key is displayed instead of changing screens.

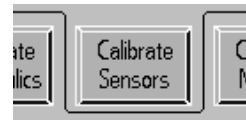

Screen Button (screen change)

Some screen buttons that change screens are not part of the bottom row of the display. To use this type of screen button it must be highlighted first. Use the navigation keys ([▲],[▼],[◀], and [▶]) to highlight the desired screen button then press the [CONFIRM] key. The screen will change.

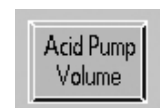

A screen button is not active if it is gray.

Screen Button (menu selection)

Some screen buttons will display a menu of choices. To display the menu, use the navigation keys ([▲],[▼],[◀], and [▶]) to highlight the screen button and press the [CONFIRM] key. The menu will be displayed with the current selection highlighted. Use the [+] and [-] data entry keys to scroll the menu list and highlight a new selection. Once a new selection is highlighted, press the [CONFIRM] key and the selection is stored and the menu list disappears. If, after the menu is displayed, a new selection is not required, press the [Escape] key to keep the current selection and make the menu disappear.

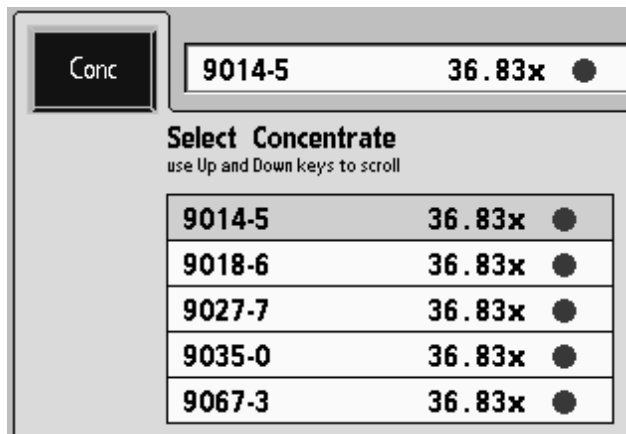

If a screen change is required while a menu is being displayed, the operator is prompted to press either the [Escape] key or the [CONFIRM] key.

Data Box

This type of box shows selected data or data the machine is measuring. During the calibration process this type of box is used to verify a value or selection.

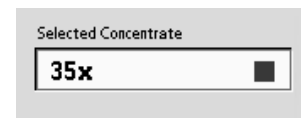

1.4 MEASURING FLUID VOLUMES

Several of the following procedures require measuring fluid volumes using graduated cylinders and laboratory burets. When making these measurements do the following:

- Make certain the container is clean and dry before collecting the fluid to be measured. Two drops of fluid are approximately 0.1ml, which is enough to affect the accuracy of critical measurements.
- Ensure that no items such as thermometers or tubing are allowed to come in contact with the fluid in the graduate. Such items will change the calibration of the graduate and affect the accuracy of measurements. Both the total volume indicated and the amount of fluid indicated by each increment on the graduated scale will be incorrect. For example, if a graduate is calibrated in 1ml increments, a piece of tubing in contact with the fluid will cause each increment to be *less* than 1ml, depending upon the total volume of the tubing that penetrates into the fluid.
- Surface tension causes the fluid to curve into a meniscus (see Figure 3). Measure the volume at the bottom of the meniscus curve as shown.

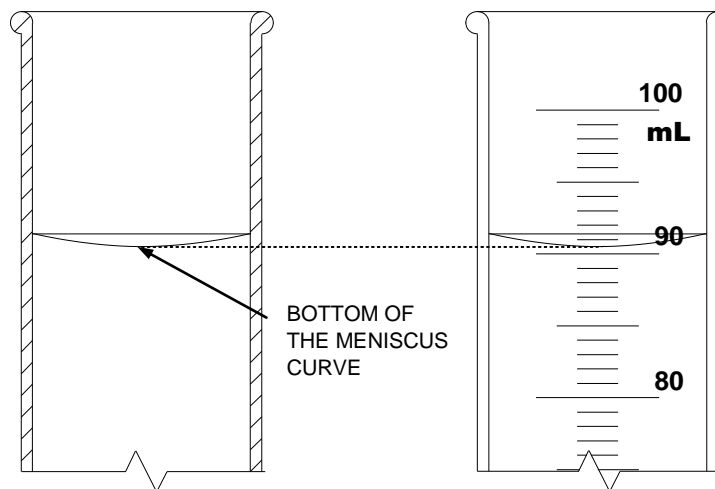

Figure 3 - Meniscus Curve

1.5 **CALIBRATE IF REPLACED**

During the process of servicing a machine, components may need to be replaced. The following table shows calibrations that must be conducted after replacing certain components.

Replaced Component	Then Calibrate	Refer to:
- Deaeration Pump Head	- Deaeration & Loading Pressure	Sec. 2.1.1
- Deaeration Motor (or rebuild)		
- Loading Pressure Relief Valve		
- Flow Pump Head	- Flow Pressure	Sec. 2.1.2
- Flow Motor (or rebuild)		
- Flow Pressure Relief Valve		
- Balance Chamber	- Balance Chamber Volume	Sec. 2.1.3
- Acid Pump	- Acid Pump Volume	Sec. 2.1.4
- Bicarbonate Pump	- Bicarbonate Pump Volume	Sec. 2.1.5
- UF Pump	- UF Pump Volume	Sec. 2.1.6
- Dialysate Pressure Transducer	- Dialysate Pressure	Sec. 2.2.3
- Temperature Sensor	- Temperature Control	Sec. 2.2.6
- Heater Bar		
- Blood Leak Detector	- Blood Leak	Sec. 2.2.7
- Conductivity Cell	- Conductivity	Sec. 2.2.8
- Functional Board (New EEPROM)	- All Calibrations	All Sections
- Actuator/Test Combo Board	- Voltage Detection	Sec. 2.3.2
- Sensor Board	- Arterial Pressure	Sec. 2.2.1
	- Venous Pressure	Sec. 2.2.2
	- Dialysate Pressure	Sec. 2.2.3
	- Temperature Sensor	Sec. 2.2.4
	- Post Temperature Sensor	Sec. 2.2.5
	- Temperature	Sec. 2.2.6
	- Blood Leak	Sec. 2.2.7
	- Conductivity	Sec. 2.2.8
	- Arterial Pump Rate	Sec. 2.3.3
- Venous Pump Rate	Sec. 2.3.4	
- Blood Pump Module	- Arterial Pressure	Sec. 2.2.1
	- Arterial Pump Rate	Sec. 2.3.3
- Level Detector Module	- Venous Pressure	Sec. 2.2.2
	- Level Detector	Sec. 3.2
- Inlet Water Pressure Regulator	- Inlet Water Pressure Regulator	Sec. 3.1

Table 1 - Calibrate if Replaced

2.0 **SERVICE MODE CALIBRATIONS**

Place the machine in Service Mode as described in Section 1.2 to perform the following procedures. The procedures do not have to be completed in any particular order. Go directly to the calibration procedures needed.

If calibration is being performed after working on the hydraulics unit, especially if the inlet water pressure regulator has been changed, we recommend that you calibrate the inlet water pressure regulator as described in Section 3.1 first.

2.1 HYDRAULIC CALIBRATION PROCEDURES

From the Service Mode screen, select¹ the Calibrate Hydraulics screen tab button. The following screen will appear showing the six hydraulic calibrations:

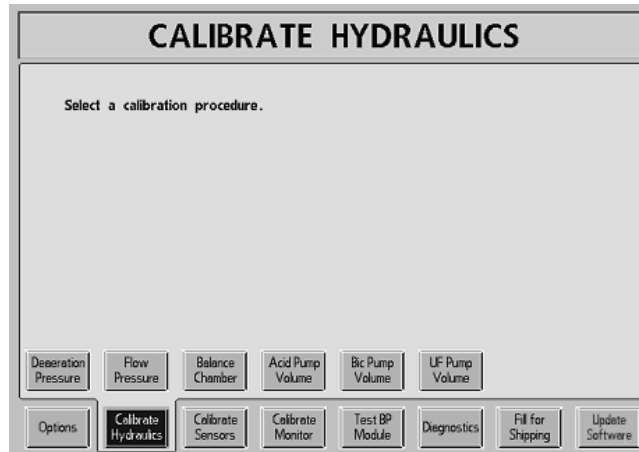

To begin a calibration, select¹ the appropriate calibration screen button.

- Deaeration Pressure
- Flow Pressure
- Balance Chamber
- Acid Pump Volume
- Bicarbonate Pump Volume
- UF Pump Volume

¹ Refer to Section 1.3 on the use of screen buttons.

2.1.1 DEAERATION AND LOADING PRESSURE CALIBRATION

From the Calibrate Hydraulics screen, select¹ the Deaeration Pressure screen button. The screen will change to the following:

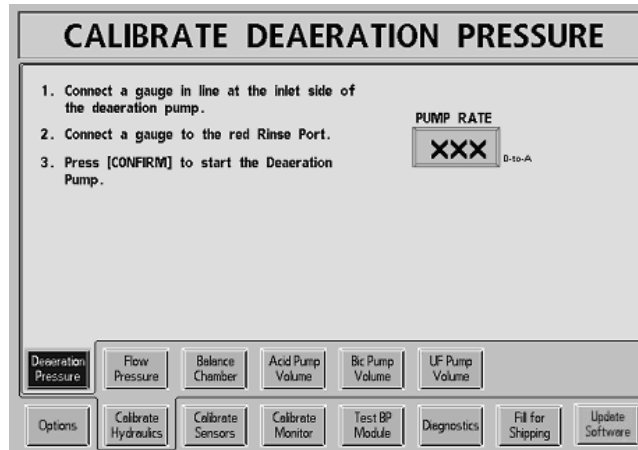

1. Connect a gauge in line at the inlet side of the deaeration pump (See Figure 1, pg. 5).



Note: The inlet side of the deaeration pump is the side with the clear plastic line. The output side has a white reinforced jacket over the line.

2. Connect a gauge equipped with a yellow connector into the red ACETATE/ACID port.
3. Press the [CONFIRM] key. The deaeration pump will start and the screen will change.

¹ Refer to Section 1.3 on the use of screen buttons.

4. Select¹ the PUMP RATE data button.
5. Adjust the PUMP RATE value to achieve a pressure reading of -24inHg on the gauge attached to the deaeration pump (see elevation note below). The gauge needle will be wiggling/vibrating slightly. Adjust the pressure so the maximum value is -24inHg and verify that the needle does not go below -25inHg.

If the pressure is unable to be achieved and the PUMP RATE is at its limit, adjust the bypass screw by turning it clockwise towards its closed position.



Caution: Do not over-tighten the bypass screw once the screw is in its fully closed position. Permanent pump head damage could result.



Note: When the machine is at a different elevation above sea level, it may be difficult or impossible to achieve -24inHg. The following table will help in determining the appropriate deaeration pressure calibration point at different elevations:

Table 2

Elevation	Approx. atmospheric pressure	Minimum target deaeration pressure relative to atmospheric pressure
feet	mmHg	inches of Hg
0	760	-24.0
1000	728	-23.0
2000	697	-22.0
3000	667	-21.0
4000	639	-20.0
5000	612	-19.0
6000	585	-18.5
7000	561	-17.5
8000	537	-16.9
9000	514	-16.2
10000	492	-15.5

¹ Refer to Section 1.3 on the use of screen buttons.

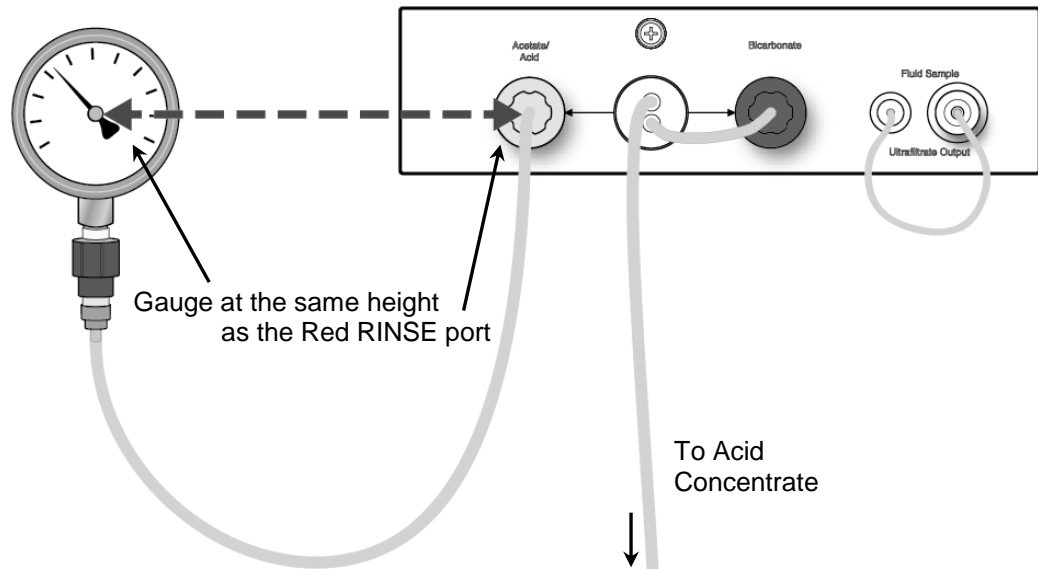

6. The loading pressure gauge in the red RINSE port will be cycling between two pressure levels. While holding the loading pressure gauge at the same height as the red RINSE port (see above), adjust pressure relief valve #65 (See Figure 1, pg. 5) for a reading between 23 and 25 psi when the gauge is reading its highest pressure level. Verify that the pressure is greater than 10 psi at the lowest level, and that it is stable within 1 psi at each level.



Note: If a DIASAFE[®] filter system is **not** installed, adjust pressure relief valve #65 for a reading between 18 and 20 psi when the gauge is reading its highest pressure level.

7. Repeat steps 5 and 6 until both readings are correct without further adjustment.
8. Press the [CONFIRM] key to save the data.

Press the [CONFIRM] key again and the screen will change.

Press the [CONFIRM] key to complete the calibration and return to the Calibrate Hydraulics screen.

Remove the gauges.

2.1.2 FLOW PRESSURE CALIBRATION

From the Calibrate Hydraulics screen, select¹ the Flow Pressure screen button. The screen will change to the following:

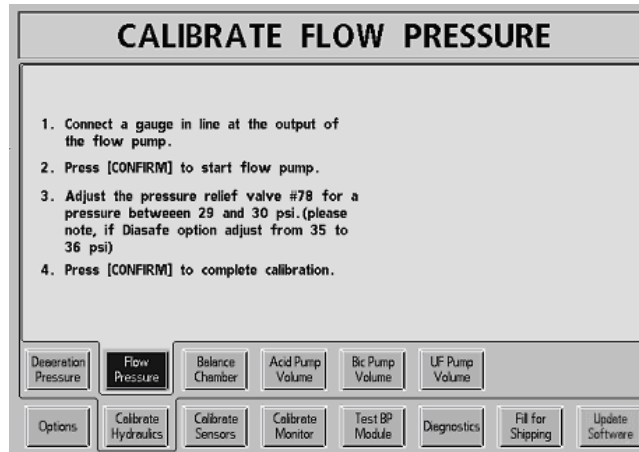

1. Connect a gauge in line at the output of the flow pump (See Figure 1, pg. 5).



Note: The output side of the flow pump is the side with the white reinforced jacket over the line. The input side has clear plastic line.

2. Press the [CONFIRM] key to start the flow pump.
3. Adjust pressure relief valve #78 (See Figure 1, pg. 5) for a pressure between 29 and 30 psi indicated on the gauge.



Note: If a DIASAFE[®] filter system is installed adjust pressure relief valve #78 for a pressure between 35 and 36 psi.

4. Press the [CONFIRM] key to complete the calibration and return to the Calibrate Hydraulics screen.

Remove the gauge from the flow pump output.

¹ Refer to Section 1.3 on the use of screen buttons.

2.1.3 BALANCE CHAMBER VOLUME CALIBRATION

The balance chamber volume is measured at the factory with a high degree of accuracy using equipment usually not available in the field. The chamber volume will not change in use. Record the factory-measured chamber volume for reference should the value need to be replaced in the EEPROM. Only perform the following procedure if the factory-measured volume has been lost, or if the balance chamber has been repaired or replaced.

From the Calibrate Hydraulics screen, select¹ the Balance Chamber screen button. The screen will change to the following:

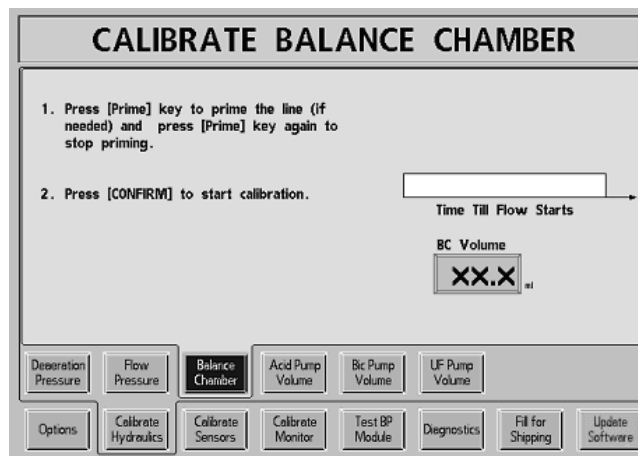

Note: Be prepared to remove the drain hose from the back of the machine (See Figure 1, pg. 5) and to collect fluid from the drain port with an empty 100ml graduated cylinder.

1. Press the [Prime] key to prime the balance chamber if needed. Press the [Prime] key again to stop this optional priming.
2. Press the [CONFIRM] key to start the calibration. The status box will change indicating the balance chamber is being prepared.

Once the balance chamber has been prepared, the screen will change and a progress bar will begin to fill from left to right. This bar is showing an approximate 15-second countdown before the contents of the balance chambers are dispensed from the drain port with two pulses of fluid.

¹ Refer to Section 1.3 on the use of screen buttons.

3. While this process is going on, remove the drain hose from the back of the machine.
4. Prepare to catch the two pulses of fluid in the empty graduated cylinder by placing it under the drain port.
5. As soon as the progress bar is completely blue, the machine will dispense the two pulses out the drain port.
6. Place the graduated cylinder on a level surface and read the volume of fluid it contains.

Select¹ the **BC Volume** data button.

Set the **BC Volume** value to the amount collected in the graduated cylinder and then press the **[CONFIRM]** key.

7. Press the **[CONFIRM]** key again to store the data. The screen will change.

Replace the drain hose on the drain port.

Press the **[CONFIRM]** key to complete the calibration and return to the **Calibrate Hydraulics** screen.

¹ Refer to Section 1.3 on the use of screen buttons.

2.1.4 ACID (CONCENTRATE) PUMP VOLUME CALIBRATION

From the Calibrate Hydraulics screen, select¹ the Acid Pump Volume screen button. The screen will change to the following:

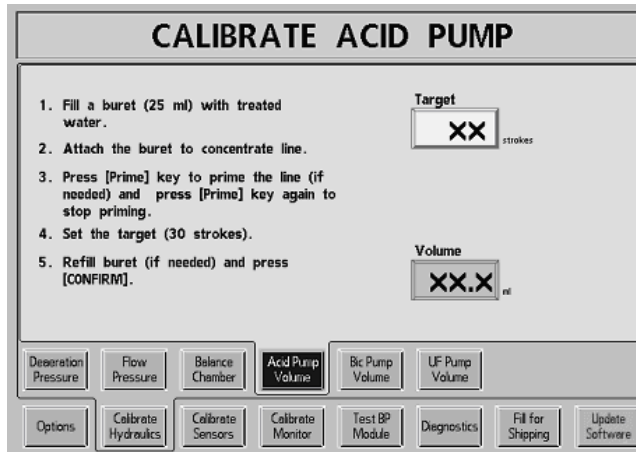

1. Fill a 25ml buret with treated water or concentrate.
2. Attach the buret to the red concentrate line with a piece of tubing.
3. Press the [Prime] key. The acid pump will begin to stroke. Allow the pump to stroke about 20 times or more to remove the air from the line then press the [Prime] key again to stop the pump.
4. Select¹ the Target data button.

Set the Target value to 30 strokes, then press the [CONFIRM] key.

5. Refill the buret exactly to the full (0ml) mark.

Press the [CONFIRM] key. The acid pump will stroke and the screen will change.

6. Wait until the Target value reaches zero.

¹ Refer to Section 1.3 on the use of screen buttons.

7. When the **Target** value reaches zero, the acid pump stops stroking.
Select¹ the **Volume** data button.
Set the **Volume** value to the measured volume, then press the **[CONFIRM]** key.
8. Press the **[CONFIRM]** key again and the screen will change.
9. Refill the buret exactly to the full (0ml) mark.



Caution: Be sure the buret did not run out of fluid and allow air to be pulled into the machine.

10. If needed, prime the line by pressing the **[Prime]** key. The acid pump will begin to stroke. Allow the pump to stroke about 20 times or more to remove the air from the line then press the **[Prime]** key again to stop the pump.
11. Select¹ the **Target** data button.
Set the **Target** value to 30 strokes, then press the **[CONFIRM]** key.
12. Refill the buret exactly to the full (0ml) mark.
Press the **[CONFIRM]** key again. The acid pump will stroke and the screen will change.
13. Wait until the **Target** value reaches zero.
14. When the **Target** value reaches zero, the acid pump stops stroking.
Select¹ the **Volume** data button.
Set the **Volume** value to the measured volume, then press the **[CONFIRM]** key.
15. Press the **[CONFIRM]** key again to save the data. The screen will change.
Press the **[CONFIRM]** key one more time to complete the calibration and return to the **Calibrate Hydraulics** screen.

¹ Refer to Section 1.3 on the use of screen buttons.

2.1.5 BICARBONATE PUMP VOLUME CALIBRATION

From the Calibrate Hydraulics screen, select¹ the Bic Pump Volume screen button. The screen will change to the following:

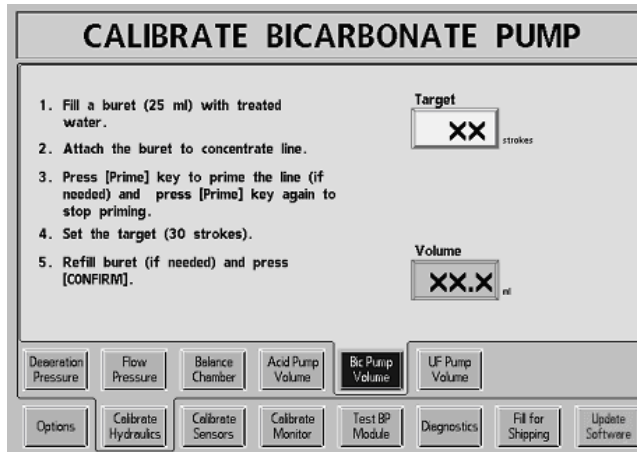

1. Fill a 25ml buret with treated water or concentrate.
2. Attach the buret to the blue bicarbonate line with a piece of tubing.
3. Press the [Prime] key. The bicarbonate pump will begin to stroke.

Allow the pump to stroke about 20 times or more to remove the air from the line then press the [Prime] key again to stop the pump.

4. Select¹ the Target data button.

Set the Target value to 30 strokes, then press the [CONFIRM] key.

5. Refill the buret exactly to the full (0ml) mark.

Press the [CONFIRM] key. The bicarbonate pump will stroke and the screen will change.

6. Wait until the Target value reaches zero.

¹ Refer to Section 1.3 on the use of screen buttons.

7. When the **Target** value reaches zero, the bicarbonate pump stops stroking.
Select¹ the **Volume** data button.
Set the **Volume** value to the measured volume, then press the **[CONFIRM]** key.
8. Press the **[CONFIRM]** key again and the screen will change.
9. Refill the buret exactly to the full (0ml) mark.



Caution: Be sure the buret did not run out of fluid and allow air to be pulled into the machine.

10. If needed, prime the line by pressing the **[Prime]** key. The acid pump will begin to stroke. Allow the pump to stroke about 20 times or more to remove the air from the line then press the **[Prime]** key again to stop the pump.
11. Select¹ the **Target** data button.
Set the **Target** value to 30 strokes, then press the **[CONFIRM]** key.
12. Refill the buret exactly to the full (0ml) mark.
Press the **[CONFIRM]** key again. The bicarbonate pump will stroke and the screen will change.
13. Wait until the **Target** value reaches zero.
14. When the **Target** value reaches zero, the bicarbonate pump stops stroking.
Select¹ the **Volume** data button.
Set the **Volume** value to the measured volume, then press the **[CONFIRM]** key.
15. Press the **[CONFIRM]** key again to save the data. The screen will change.
Press the **[CONFIRM]** key one more time to complete the calibration and return to the **Calibrate Hydraulics** screen.

¹ Refer to Section 1.3 on the use of screen buttons.

2.1.6 UF PUMP VOLUME CALIBRATION

From the Calibrate Hydraulics screen, select¹ the UF Pump Volume screen button. The screen will change to the following:

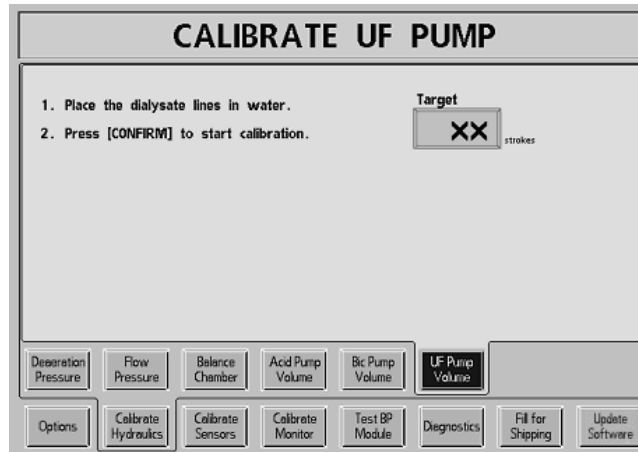

1. Remove the dialysate lines from the shunt and place them in a bucket of water.
2. Press the [CONFIRM] key to start the calibration. The screen will change.
3. Remove the tubing from the FLUID SAMPLE / ULTRA-FILTRATE OUTPUT port and connect it to a 25ml buret. Open the buret stopcock.
4. Press the [Prime] key. The UF pump will begin to stroke.

Allow the pump to stroke about 20 times or more to remove the air from the line then press the [Prime] key again to stop the pump.

Add or remove fluid from the buret so the meniscus is exactly on the 25ml mark (see Figure 4).

¹ Refer to Section 1.3 on the use of screen buttons.

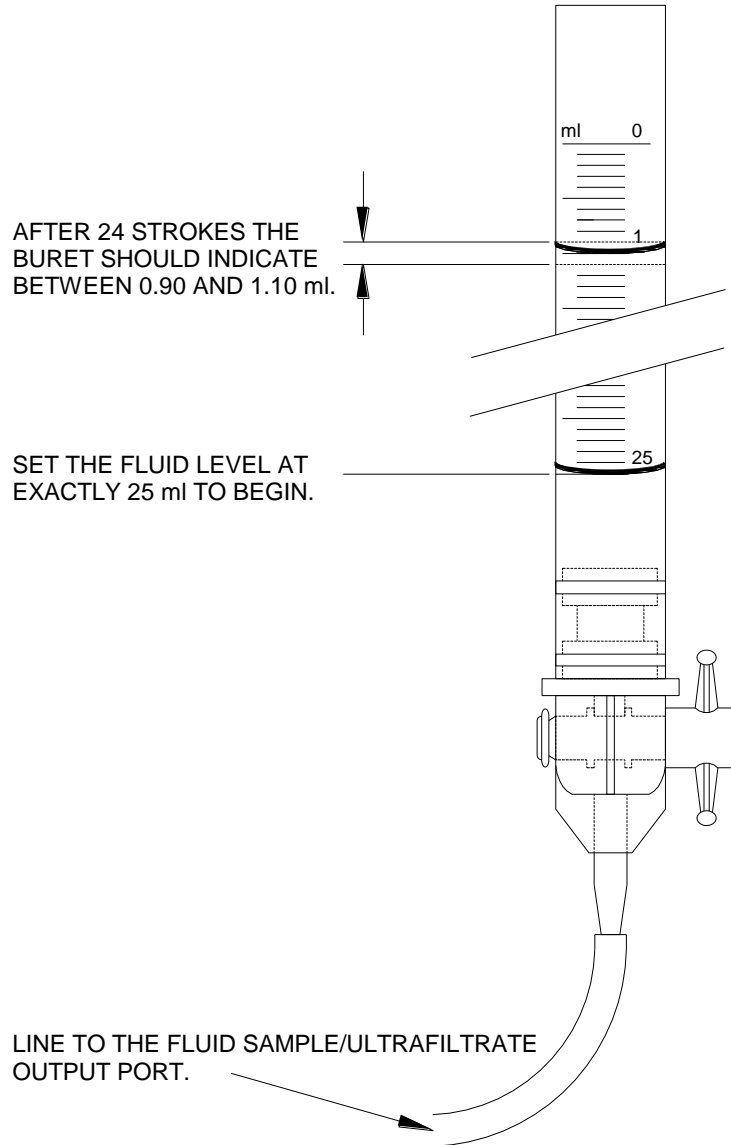

Figure 4 - UF Pump Volume Measurement

5. Select¹ the Target data button.
Set the Target value to 24 strokes, then press the [CONFIRM] key.
6. Press the [CONFIRM] key again. The UF pump will stroke and the screen will change.
7. Wait until the Target value reaches zero.

¹ Refer to Section 1.3 on the use of screen buttons.

8. When the **Target** value reaches zero, the UF pump will stop. Measure the fluid collected in the buret. The buret scale should indicate between 0.90 and 1.10ml, indicating that between 23.90 and 24.10ml of fluid was collected (see Figure 4). If the volume collected is not within this range, adjust the UF pump volume as follows:
 - On the rear center of the hydraulics assembly, remove the plastic cap covering the pump adjustment screw (See Figure 1, pg. 5).
 - Loosen the locking nut and turn the screw clockwise to decrease or counter-clockwise to increase the pump volume.



Note: Turning the adjustment screw approximately the width of the screwdriver slot will change the amount of fluid collected in 24 strokes by about 0.25ml. After making adjustments, prime the pump again.

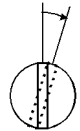

- Tighten the locking nut while holding the adjustment screw with screwdriver before proceeding.
 - Press the [Escape] key and repeat the **UF Pump Volume** calibration until the fluid fills the buret to between 0.90 and 1.10 on the scale after 24 strokes of the UF pump.
9. Replace the plastic cap on the UF pump adjustment.

Press the [CONFIRM] key to complete the calibration and return to the **Calibrate Hydraulics** screen.

2.2 SENSOR CALIBRATION PROCEDURES

From the Service Mode screen, select¹ the Calibrate Sensors screen button. The following screen will appear showing the eight sensor calibrations:

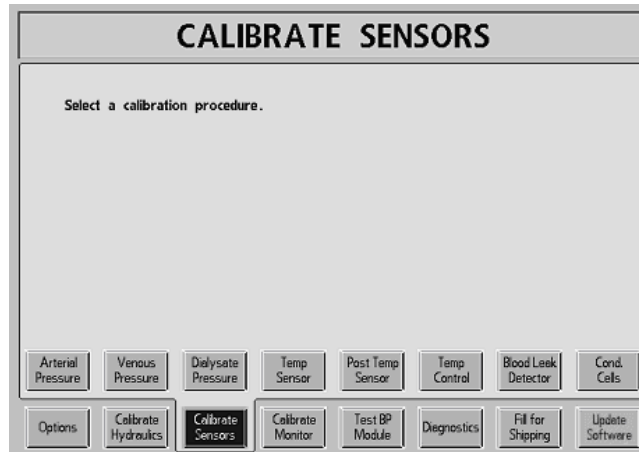

To begin a calibration, select¹ the appropriate calibration screen button.

- Arterial Pressure
- Venous Pressure
- Dialysate Pressure
- Temperature Sensor
- Post Temperature Sensor
- Temperature Control
- Blood Leak Detector
- Conductivity Cells

¹ Refer to Section 1.3 on the use of screen buttons.

2.2.1 ARTERIAL PRESSURE CALIBRATION

The arterial blood pump does not use potentiometers to calibrate the arterial pressure. Instead, it stores a value in the blood pump. In order to calibrate the arterial pressure, the pump must be put into its own Service Mode. This is done by moving the Service Jumper located on the blood pump LP955 board. Refer to Figure 5 for location and positioning of the Service Jumper.



Note: The DIP switches and Service Jumper on the blood pump must be set prior to turning the machine ON.

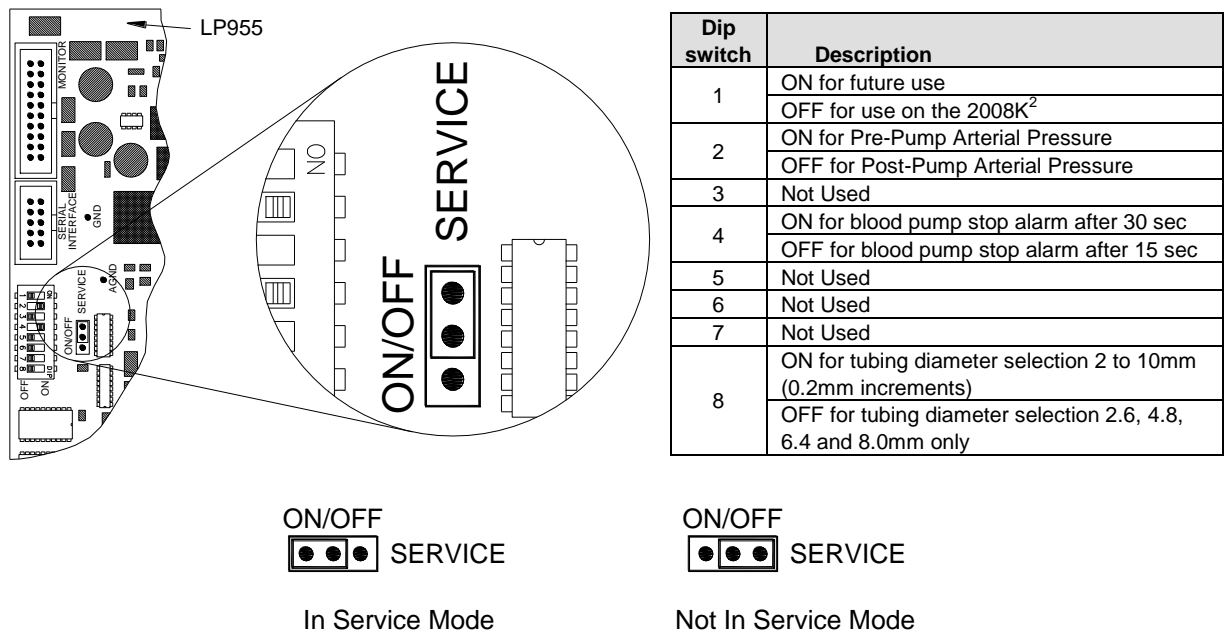
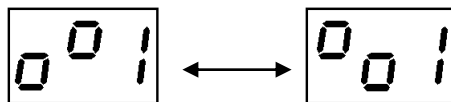

Figure 5 –Blood Pump DIP switches & Service Jumper

The following procedure calibrates the pressure sensor on the arterial blood pump.

- With the machine turned OFF, position the blood pump Service Jumper into the In Service Mode position.
- Locate DIP switch 2 on the blood pump LP955 board and configure it as follows:
 - For prepump, DIP switch 2 must be in the ON position
 - For postpump, DIP switch 2 must be in the OFF position
- Power the 2008K² machine ON and enter Service Mode.
- When the power up sequence is complete, the blood pump display will be alternating between these two displays:



Note: If the above display has a number 2 instead of a number 1, press the [▼] down key on the blood pump control panel to change it to 1.

From the Calibrate Sensors screen, select¹ the Arterial Pressure screen button. The screen will change to the following:

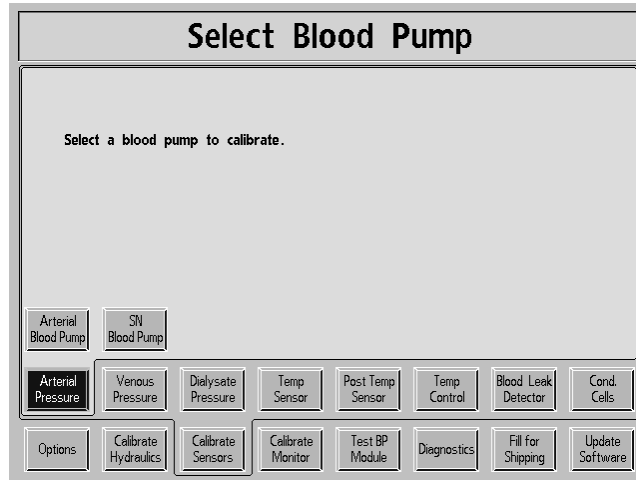

Select¹ the Arterial Blood Pump screen button and the screen will change to the following:

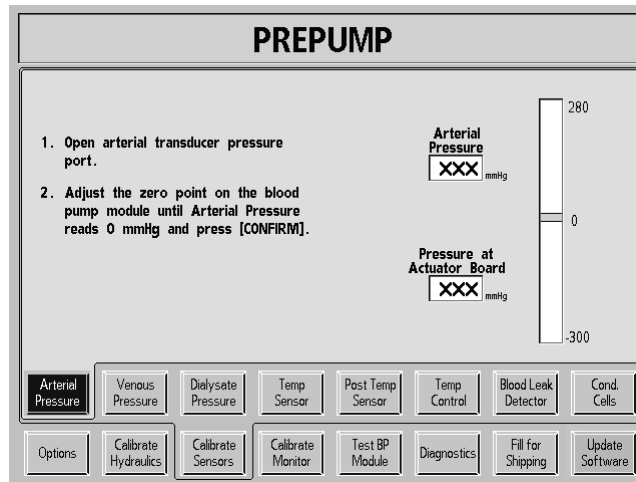

Note: Depending on the HARDWARE OPTION set for the ART PUMP option, the above display may read POSTPUMP instead of PREPUMP. The bargraph scale will also be different (500 to -80mmHg).

¹ Refer to Section 1.3 on the use of screen buttons.

1. Open arterial transducer port P_{ART} on the blood pump module to air (atmospheric pressure).



Note: Use the Arterial Level Adjust [▲] key on the blood pump control panel to abort the calibration process without changing the stored DAC value on the blood pump.

Press the [Start/Stop] key on the blood pump and its display will change to the following:

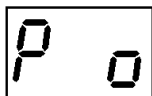

Press the [Start/Stop] key again and the small zero will start to flash.

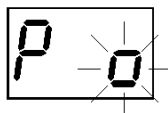

2. Use the [▲] and [▼] keys on the blood pump to adjust the Arterial Pressure data box on the 2008K² display to indicate 0 mmHg.

Press the [CONFIRM] key and the 2008K² display will change.

Press the [Start/Stop] key on the blood pump and its display will change back to the following alternating display:

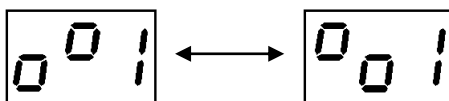

Press the [Start/Stop] key again and the display will change to the following:

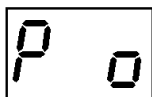

Press the [▲] key on the blood pump to change it to the following:

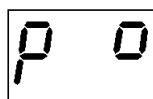

Press the [Start/Stop] key and the small zero will start to flash.

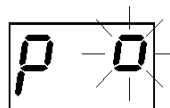

3. Attach a syringe and a calibrated pressure gauge to the P_{ART} port using a T- fitting.
4. Push the syringe plunger in to show a pressure of 200mmHg on the external pressure gauge.
5. While holding this pressure, do the following:
 - Use the [▲] and [▼] keys on the blood pump to adjust the Arterial Pressure data box on the 2008K² display to indicate 200mmHg.
 - Press the [CONFIRM] key and the 2008K² display will change.
 - Press the [Start/Stop] key on the blood pump and its display will change back to the alternating display:

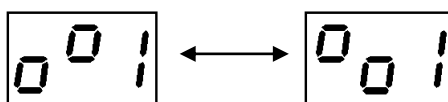

- Verify that the Arterial Pressure and Pressure at Actuator Board meter boxes are within 10 mmHg of each other.



Note: After pressing the [CONFIRM] key, a delay of approximately 8 seconds may occur before the Pressure at Actuator Board data box changes to be within 10 mmHg of the Arterial Pressure data box on the display screen.

6. Pressurize the **P_{ART}** port by either pushing or pulling on the syringe.
7. Verify that the Arterial Pressure and Pressure at Actuator Board meter boxes can reach at least 290mmHg (510mmHg for postpump) and that they are within 10mmHg of each other.

Verify that the Arterial Pressure and Pressure at Actuator Board meter boxes can reach at least -310mmHg (-90mmHg for postpump) and that they are within 10mmHg of each other.

8. Press the [CONFIRM] key to save the data. The screen will change.



Caution: The following step must be performed on the blood pump or the calibration data you just collected and tested will be lost when the machine is turned off.

Press the [▲] and [▼] keys on the blood pump at the same time to save the DAC values to the blood pump memory. While pressing both keys, the blood pump display will show dashes as shown below:

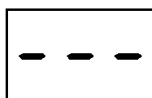

Press the [CONFIRM] key to complete the calibration and return to the Calibrate Sensors screen.

Power the machine OFF and move the blood pump Service Jumper into the Not in Service Mode position (see Figure 5).

2.2.2 VENOUS PRESSURE CALIBRATION

From the Calibrate Sensors screen, select¹ the Venous Pressure screen button. The screen will change to the following:

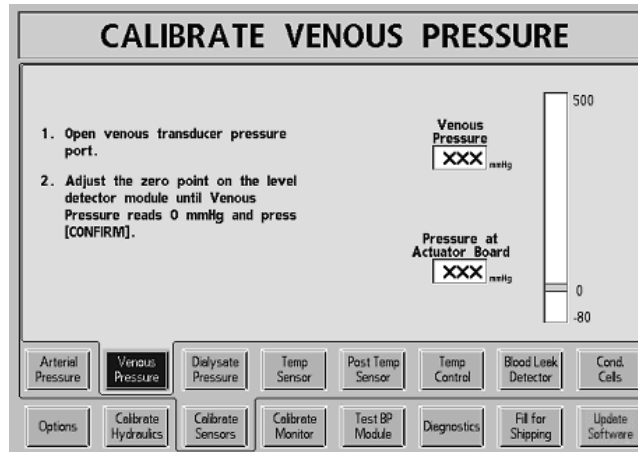

1. Open the venous transducer port P_{VEN} on the level detector module to air (atmospheric pressure).
2. Adjust the ZERO SET potentiometer (see Figure 6) so that the Venous Pressure data box indicates zero mmHg.

Press the [CONFIRM] key and the screen will change.

3. Attach a syringe and a calibrated pressure gauge to the P_{VEN} port using a T- fitting.

¹ Refer to Section 1.3 on the use of screen buttons.

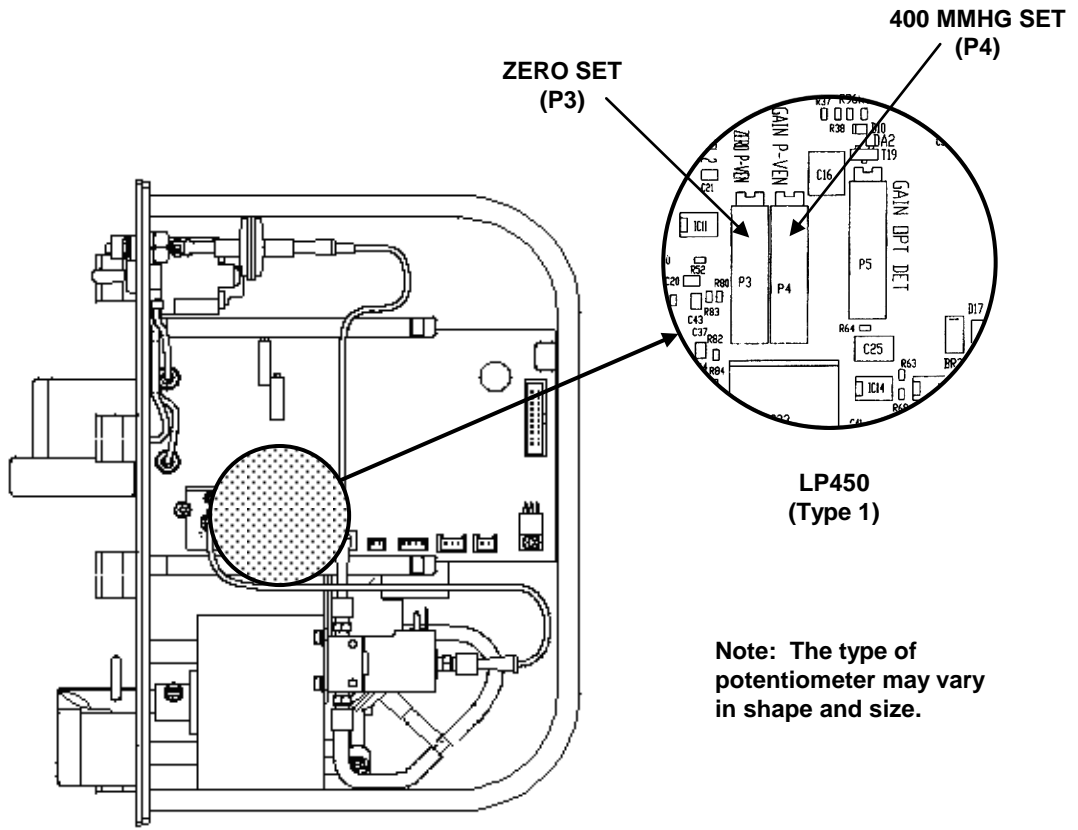

Figure 6 - Venous Pressure Display Adjustments

4. Push the syringe plunger in to show a pressure of 400mmHg on the external pressure gauge.
5. While holding this pressure, do the following:
 - Adjust the 400 MMHG SET potentiometer (see Figure 6) so the Venous Pressure data box indicates 400 mmHg.
 - Press the [CONFIRM] key and the screen will change.
 - Verify that the Venous Pressure and Pressure at Actuator Board meter boxes are within 10 mmHg of each other.



Note: After pressing the [CONFIRM] key, a delay of approximately 8 seconds may occur before the Pressure at Actuator Board data box changes to be within 10 mmHg of the Venous Pressure data box on the display screen.

6. Pressurize the P_{VEN} port by either pushing or pulling on the syringe.
7. Verify that the Venous Pressure and Pressure at Actuator Board meter boxes can reach at least 510mmHg and that they are within 10mmHg of each other.

Verify that the Venous Pressure and Pressure at Actuator Board meter boxes can reach at least -90mmHg and that they are within 10mmHg of each other.

8. Press the [CONFIRM] key to save the calibration. The screen will change.

Press the [CONFIRM] key again to complete the calibration and return to the Calibrate Sensors screen.

2.2.3 DIALYSATE PRESSURE CALIBRATION

1. Hang a four-way connector on the I.V. pole at the normal dialyzer height. Remove the dialyzer lines from the shunt and attach them to the connector.



Note: The four-way connector is included in the Test Kit part number 150034.

Connect a 30cc syringe to one of the four-way connector outlets and clamp the tubing.

Connect an external pressure gauge to the remaining four-way connector outlet and clamp the tubing.

From the Calibrate Sensors screen, select¹ the Dialysate Pressure screen button. The screen will change to the following:

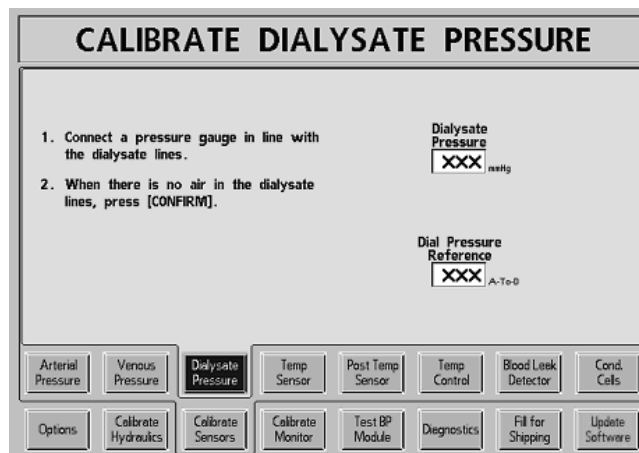

2. Dialysate should be flowing, as indicated by the flow indicator in the dialysate lines.



Note: If there is no dialysate flow through the flow indicator, make sure the yellow [Dialysate Flow on/off] light is off and the shunt door is closed.

Wait approximately one minute after the flow has been verified to ensure NO AIR is present at the dialysate pressure transducer #9 in the hydraulic flow path. Press the [CONFIRM] key and the screen will change.

¹ Refer to Section 1.3 on the use of screen buttons.

3. Press the [Dialysate Flow on/off] key to stop dialysate flow.
Unclamp the lines leading to the 30cc syringe and the pressure gauge.
4. Use the syringe to create a pressure reading of 0mmHg on the external pressure gauge.
5. While holding this pressure, press the [CONFIRM] key. The screen will change.
6. Use the syringe to create pressure reading of -250mmHg on the external pressure gauge.
7. While holding this pressure, press the [CONFIRM] key to save the data. The screen will change.
8. Open the shunt and remove the lines from the external pressure gauge. Replace them on the shunt and close the door.
9. Press the [Dialysate Flow on/off] key to start dialysate flow.

Press the [CONFIRM] key to complete the calibration and return to the Calibrate Sensors screen.

2.2.4 TEMPERATURE SENSOR CALIBRATION

Perform the temperature sensor calibration as follows using the test connector set referenced in Section 1.1. The display screen calls for connecting specific resistances to the X3 (MON-NTC) connector position on the distribution panel (See Figure 1, pg. 5) for each test. The test connectors contain resistors which are the closest 1% tolerance resistor available to these values. In the following procedure, each test connector is identified by the number marked on its cover.

From the Calibrate Sensors screen, select¹ the Temp Sensor screen button. The screen will change to the following:

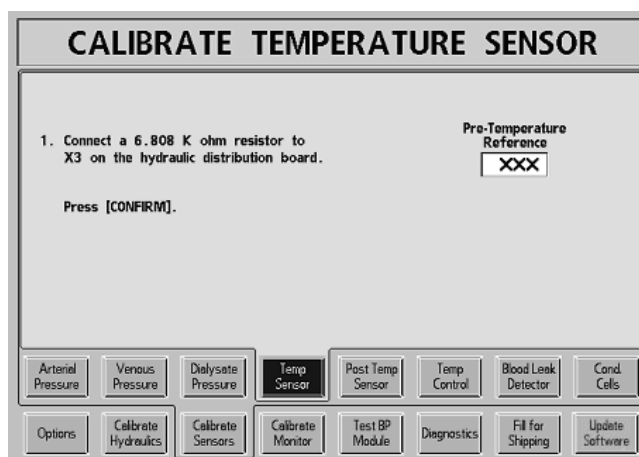

1. Remove the distribution board cover from the back of the machine.

Unplug the X3 (MON-NTC) connector from the distribution board.

Connect test connector 34 (6.808K Ω) into X3 (MON-NTC) connection on the distribution board.

Press the [CONFIRM] key to save the data. The screen will change.

2. Remove the previous test connector and connect test connector 41 (5.117K Ω) into X3 (MON-NTC) connection on the distribution board.

Press the [CONFIRM] key to save the data. The screen will change.

¹ Refer to Section 1.3 on the use of screen buttons.

3. Remove the previous test connector and connect test connector 80 (1.255K Ω) into X3 (MON-NTC) connection on the distribution board.

Press the [CONFIRM] key to save the data. The screen will change.

4. Remove the previous test connector and connect test connector 90 (0.915K Ω) into X3 (MON-NTC) connection on the distribution board.

Press the [CONFIRM] key to save the data.

5. The screen will confirm the calibration has been saved:

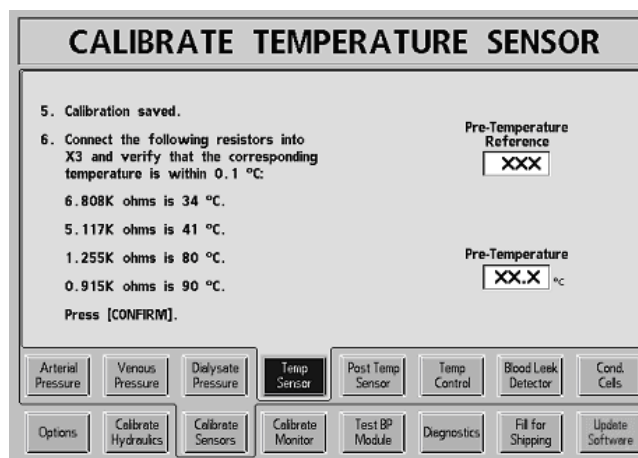

6. Insert each of the test connectors into X3 (MON-NTC) to confirm the saved calibration data. Each connector must be within 0.1°C of the Pre-Temperature data box.

Press the [CONFIRM] key to complete the calibration and return to the Calibrate Sensors screen.

Remove the test connector and replace the X3 (MON-NTC) connector on the distribution board.

2.2.5 POST TEMPERATURE SENSOR CALIBRATION

Perform the post temperature sensor calibration as follows using the test connector set referenced in Section 1.1. The display screen calls for connecting specific resistances to the X44 (NTC-POST) connector position on the distribution panel (See Figure 1, pg. 5) for each test. The test connectors contain resistors which are the closest 1% tolerance resistor available to these values. In the following procedure, each test connector is identified by the number marked on its cover.

From the Calibrate Sensors screen, select¹ the Post Temp Sensor screen button. The screen will change to the following:

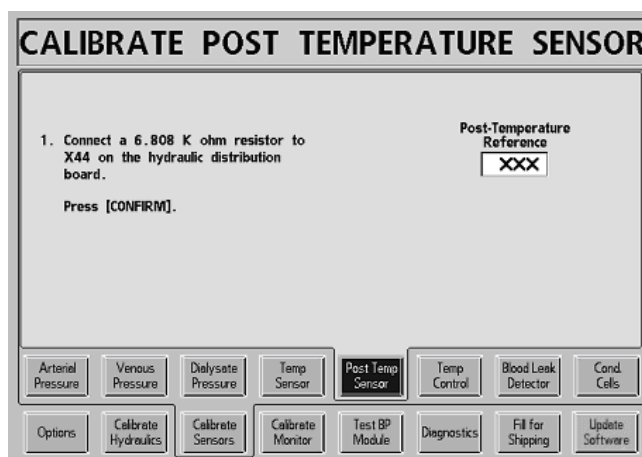

1. Remove the distribution board cover from the back of the machine.

Unplug the X44 (NTC-POST) connector from the distribution board.

Connect test connector 34 (6.808K Ω) into X44 (NTC-POST) connection on the distribution board.

Wait for the Post-Temperature Reference data box to stabilize.

Press the [CONFIRM] key to save the data. The screen will change.

¹ Refer to Section 1.3 on the use of screen buttons.

2. Remove the previous test connector and connect test connector 41 (5.117K Ω) into X44 (NTC-POST) connection on the distribution board.

Wait for the Post-Temperature Reference data box to stabilize.

Press the [CONFIRM] key to save the data.

3. The screen will confirm the calibration has been saved:

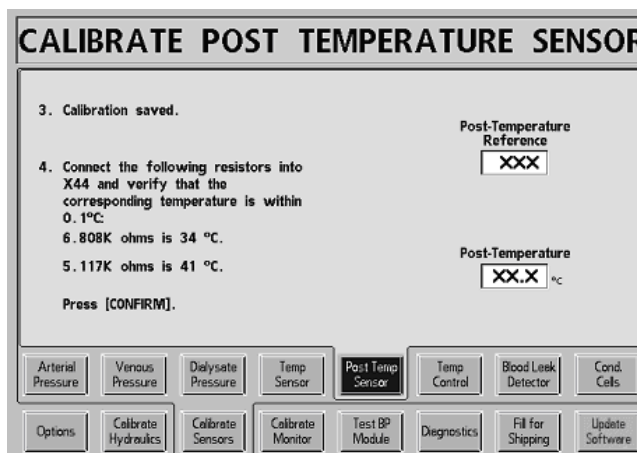

4. Insert each of the test connectors into X44 (NTC-POST) to confirm the saved calibration data. Each connector must be within 0.1°C of the Post-Temperature data box.

Press the [CONFIRM] key to complete the calibration and return to the Calibrate Sensors screen.

Remove the test connector and replace the X44 (NTC-POST) connector on the distribution board.

2.2.6 TEMPERATURE CONTROL CALIBRATION

The Temperature Control Calibration is dependent upon enabled options. Perform the appropriate calibration according to the list below:



Note: If the Online Clearance (OLC) option is installed, the Service Mode option for OLC must be set to **Yes** in Hardware Options.



Perform section 2.2.6.1 if all the following apply:

- OLC option not installed OR OLC option is installed but Temp Comp option is disabled.
- Slow Flow option is disabled.

Perform section 2.2.6.2 if all the following apply:

- OLC option not installed OR OLC option is installed but Temp Comp option is disabled.
- Slow Flow option is enabled.

Perform section 2.2.6.3 if all the following apply:

- OLC option is installed and Temp Comp option is enabled.
- Slow Flow option is disabled.

Perform section 2.2.6.4 if all the following apply:

- OLC option is installed and Temp Comp option is enabled.
- Slow Flow option is enabled.

2.2.6.1 TEMPERATURE CONTROL CALIBRATION (METHOD 1)

Perform this section only if the machine is equipped with the following:

- The machine does not have the OLC option installed OR OLC option is installed but the Temp Comp option is disabled and the slow flow option is disabled.



Note: If the OLC option is installed, the Service Mode option for OLC must be set to Yes in Hardware Options.

Replace any panels that have been removed so that the machine is closed up as it would be in normal operation. It is important for this calibration that ventilation around the hydraulics unit be the same as it is when the machine is used for dialysis.

From the Calibrate Sensors screen, select¹ the Temp Control screen button. The screen will change to the following:

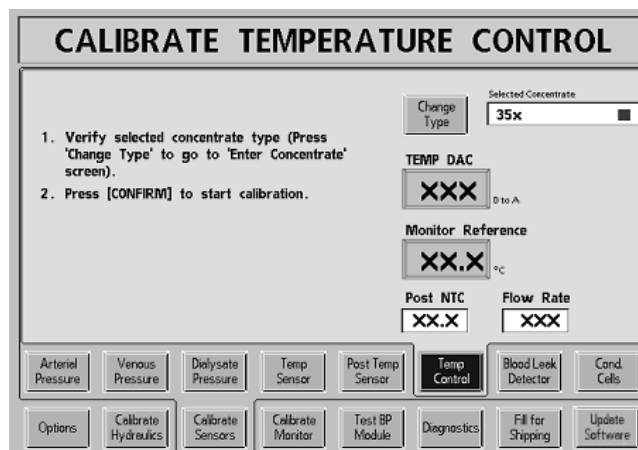

¹ Refer to Section 1.3 on the use of screen buttons.

1. Verify in the **Selected Concentrate** box that the type of concentrate used is selected.

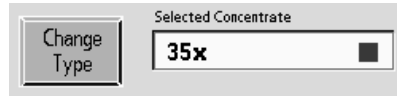

If not correct, select¹ the **Change Type** button.



Note: If the **Change Type** button is selected¹, the **Enter Conc** screen will be displayed. Change the selected concentrate and then select¹ **Calibrate Sensors** screen key and then **Temp Control** screen button to return to step 1 above.

2. Press the **[CONFIRM]** key to start the calibration. The screen will change.
3. Connect the red and blue concentrate connectors to concentrate solutions as in normal dialysis operation.
4. Remove the dialysate lines from the shunt and connect them to an external temperature meter. Close the shunt door.
5. Press the **[CONFIRM]** key and the screen will change.
6. Select¹ the **TEMP DAC** data button.

Adjust the **TEMP DAC** value, then press the **[CONFIRM]** key.



Note: Changing the **DAC** value by 2 or 3 units will produce a temperature change of about 0.1°C. Wait for the temperature to change and stabilize before changing it again to avoid overshooting the proper setting.



Note: The **TEMP DAC** value does not take effect until the **[CONFIRM]** key is pressed and the **TEMP DAC** data button is light yellow.

¹ Refer to Section 1.3 on the use of screen buttons.

The temperature of the dialysate shown on the external meter will change after a delay. Find a TEMP DAC value that produces a temperature on the external meter of 37°C.

Wait five minutes after the last adjustment of the TEMP DAC value, then verify that the temperature on the external meter has remained at 37°C. If not, change the TEMP DAC value, and wait five minutes again.

7. When the temperature remains at 37°C, press the [CONFIRM] key. The screen will change.
8. Select¹ the Monitor Reference data button.

Adjust the value shown for Monitor Reference until it matches the external temperature meter at 37°C and then press the [CONFIRM] key.

9. Press the [CONFIRM] key again to save the data. The screen will change.

Open the shunt to stop the dialysate flow, remove the lines from the external meter and replace them on the shunt.

Press the [CONFIRM] key to complete the calibration and return to the Calibrate Sensors screen.

¹ Refer to Section 1.3 on the use of screen buttons.

2.2.6.2 TEMPERATURE CONTROL CALIBRATION (METHOD 2)

Perform this section only if the machine is equipped with the following:

- The machine does not have the OLC option installed OR OLC option is installed but the Temp Comp option is disabled and the slow flow option is enabled.



Note: If the OLC option is installed, the Service Mode option for OLC must be set to Yes in Hardware Options.

If the slow flow option is enabled, the Temp Control calibration is done in two parts. The DAC and temperature monitor calibration is performed at 500ml/min flow rate and then it is calibrated at a 100ml/min flow rate.

Replace any panels that have been removed so that the machine is closed up as it would be in normal operation. It is important for this calibration that ventilation around the hydraulics unit be the same as it is when the machine is used for dialysis.

From the Calibrate Sensors screen, select¹ the Temp Control screen button. The screen will change to the following:

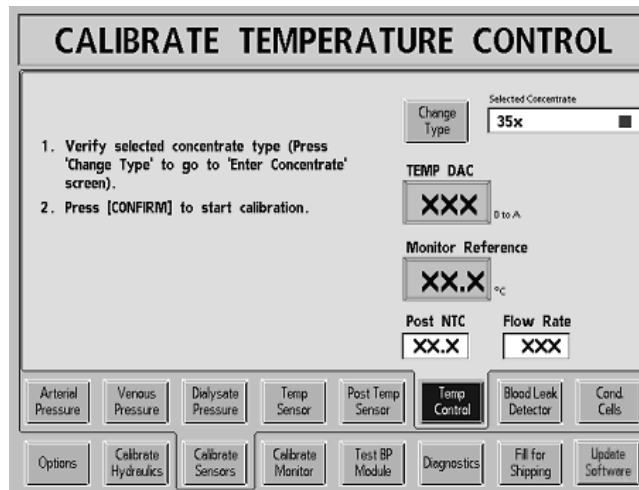

¹ Refer to Section 1.3 on the use of screen buttons.

1. Verify in the **Selected Concentrate** box that the type of concentrate used is selected.

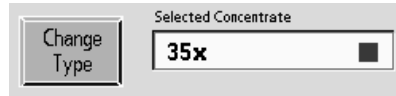

If not correct, select¹ the Change Type button.



Note: If the Change Type button is selected¹, the Enter Conc screen will be displayed. Change the selected concentrate and then select¹ Calibrate Sensors screen key and then Temp Control screen button to return to step 1 above.

2. Press the [CONFIRM] key to start the calibration. The screen will change.
3. Connect the red and blue concentrate connectors to concentrate solutions as in normal dialysis operation.
4. Remove the dialysate lines from the shunt and connect them to an external temperature meter. Close the shunt door.
5. Press the [CONFIRM] key and the screen will change.
6. The Temp Control calibration begins with the flow at 500ml/min.

Select¹ the TEMP DAC data button.

Adjust the TEMP DAC value, then press the [CONFIRM] key.



Note: Changing the DAC value by 2 or 3 units will produce a temperature change of about 0.1°C. Wait for the temperature to change and stabilize before changing it again to avoid overshooting the proper setting.



Note: The TEMP DAC value does not take effect until the [CONFIRM] key is pressed and the TEMP DAC data button is light yellow.

¹ Refer to Section 1.3 on the use of screen buttons.

The temperature of the dialysate shown on the external meter will change after a delay. Find a TEMP DAC value that produces a temperature on the external meter of 37°C.

Wait five minutes after the last adjustment of the TEMP DAC value, then verify that the temperature on the external meter has remained at 37°C. If not, change the TEMP DAC value, and wait five minutes again.

7. When the temperature remains at 37°C, press the [CONFIRM] key. The screen will change.
8. Select¹ the Monitor Reference data button.

Adjust the value shown for Monitor Reference until it matches the external temperature meter at 37°C and then press the [CONFIRM] key.

9. Press the [CONFIRM] key again and the screen will change.
10. The Temp Control calibration now changes the flow to 100ml/min.

Press the [CONFIRM] key and then select the TEMP DAC data button.

Adjust the TEMP DAC value, then press the [CONFIRM] key.



Note: The TEMP DAC value does not take effect until the [CONFIRM] key is pressed and the TEMP DAC data button is light yellow.

The temperature of the dialysate shown on the external meter will change after a delay. Find a TEMP DAC value that produces a temperature on the external meter of 37°C. Be patient, the 100ml/min flow rate calibration takes time.



Note: Depending on the incoming water temperature, the DAC value during the 100ml/min flow calibration may have to be set to the maximum (255). If the temperature is less than 37°C, the DAC value is at 255, and enough time has passed, go ahead and save the DAC value of 255. This circumstance will be compensated for in Dialysis Mode.

¹ Refer to Section 1.3 on the use of screen buttons.

Wait five minutes after the last adjustment of the TEMP DAC value, and then verify that the temperature on the external meter has remained at 37°C. If not, change the TEMP DAC value, and wait five minutes again.

11. When the temperature remains at 37°C, press the [CONFIRM] key. The screen will change.

12. Select¹ the Monitor Reference data button.

Adjust the value shown for Monitor Reference until it matches the external temperature meter at 37°C and then press the [CONFIRM] key.

13. Press the [CONFIRM] key again to save the data. The screen will change.

Open the shunt to stop the dialysate flow, remove the lines from the external meter and replace them on the shunt.

Press the [CONFIRM] key to complete the calibration and return to the Calibrate Sensors screen.

2.2.6.3 TEMPERATURE CONTROL CALIBRATION (METHOD 3)

Perform this section only if the machine is equipped with the following:

- The machine has the OLC option installed AND the Temp Comp option is enabled and the slow flow option is disabled.



Note: If the OLC option is installed, the Service Mode option for OLC must be set to Yes in Hardware Options.



Note: The Temp Comp option uses post temperature sensor NTC44. Do not attempt to calibrate a non-OLC machine with the Temp Comp option enabled since NTC44 is not present and an Operator Error will occur.

Replace any panels that have been removed so that the machine is closed up as it would be in normal operation. It is important for this calibration that ventilation around the hydraulics unit be the same as it is when the machine is used for dialysis.

From the Calibrate Sensors screen, select¹ the Temp Control screen button. The screen will change to the following:

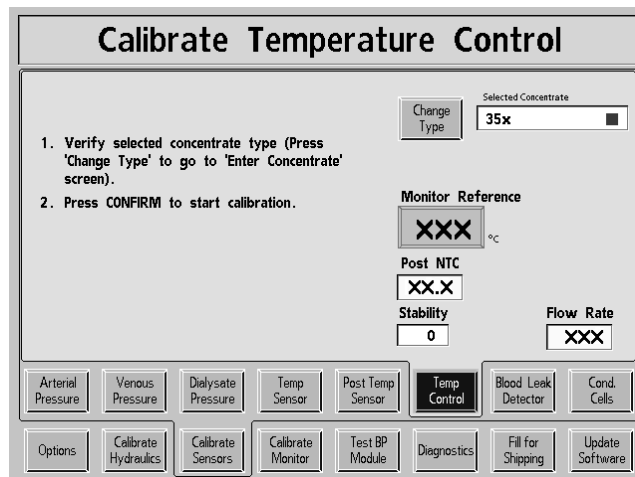

¹ Refer to Section 1.3 on the use of screen buttons.

1. Verify in the **Selected Concentrate** box that the type of concentrated used is selected.

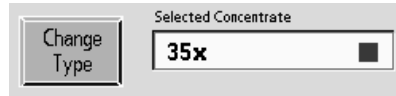

If not correct, select¹ the **Change Type** button.



Note: If the **Change Type** button is selected¹, the **Enter Conc** screen will be displayed. Change the selected concentrate and then select¹ **Calibrate Sensors** screen key and then **Temp Control** screen button to return to step 1 above.

Connect the red and blue concentrate connectors to concentrate solutions as in normal dialysis operation.

2. Press the [**CONFIRM**] key to start the calibration. The screen will change.
3. Remove the dialysate lines from the shunt and connect them to an external temperature meter. Close the shunt door.
4. Press the [**CONFIRM**] key and the screen will change.
5. The screen will display **Please wait, getting stable temperature**.

The machine will run at a 500ml/min flow rate to bring up conductivity and temperature. When the temperature becomes stable, the **Stability** counter will start to count up. As soon as it is greater than 70 a 2-minute **Timer** starts to count down. During this time the **Stability** counter will continue to increase to 100 and stay at 100 for the remaining 2-minutes. Once the 2-minutes **Timer** reaches zero, the screen will change.



Note: If the **Stability** counter drops below 70 during the 2-minute **Timer**, the 2-minutes will be reset and will wait for the **Stability** counter to be greater than 70 again.

¹ Refer to Section 1.3 on the use of screen buttons.

6. Select¹ the Monitor Reference data button.

Adjust the value shown for Monitor Reference until it matches the external temperature and then press the [CONFIRM] key and the screen will change.

7. Press the [CONFIRM] key again and the screen will display Please wait, getting stable temperature.

The machine now runs in bypass at a 500ml/min flow rate for 2-minutes. Once the 2-minute Timer has reached zero, a 6-minute Timer is set. The machine continues to run in bypass and at a 500ml/min flow rate and depending on the stability, the 6-minute Timer may start to count down. It is normal for the Stability counter to decrease during this time. If the Stability counter becomes less than 70, the Timer will be reset to 6-minutes and will wait for the Stability counter to be greater than 70 again. Once the 6-minute Timer reaches zero, the screen will change.

8. Press the [CONFIRM] key to save the data. The screen will change.

Open the shunt to stop the dialysate flow, remove the lines from the external meter and replace them on the shunt.

Press the [CONFIRM] key to complete the calibration and return to the Calibrate Sensors screen.

¹ Refer to Section 1.3 on the use of screen buttons.

2.2.6.4 TEMPERATURE CONTROL CALIBRATION (METHOD 4)

Perform this section only if the machine is equipped with the following:

- The machine has the OLC option installed AND the Temp Comp option is enabled and the slow flow option is enabled.



Note: If the OLC option is installed, the Service Mode option for OLC must be set to Yes in Hardware Options.



Note: The Temp Comp option uses post temperature sensor NTC44. Do not attempt to calibrate a non-OLC machine with the Temp Comp option enabled since NTC44 is not present and an Operator Error will occur.

If the slow flow option is enabled, the Temp Control calibration is done in two parts. The DAC and temperature monitor calibration is performed at 500ml/min flow rate and then it is calibrated at a 100ml/min flow rate.

Replace any panels that have been removed so that the machine is closed up as it would be in normal operation. It is important for this calibration that ventilation around the hydraulics unit be the same as it is when the machine is used for dialysis.

From the Calibrate Sensors screen, select¹ the Temp Control screen button. The screen will change to the following:

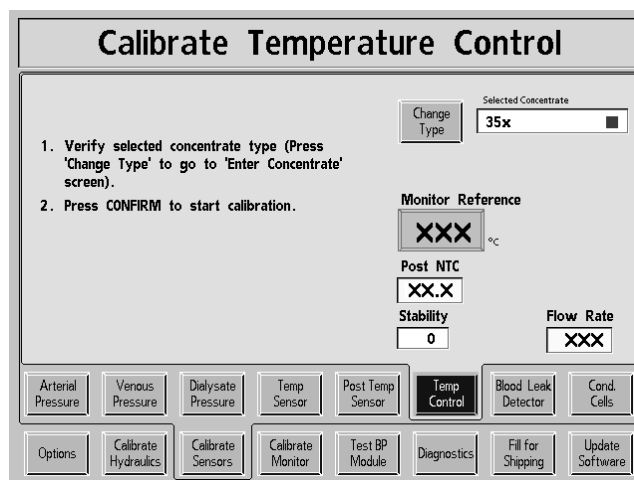

¹ Refer to Section 1.3 on the use of screen buttons.

1. Verify in the **Selected Concentrate** box that the type of concentrate used is selected.

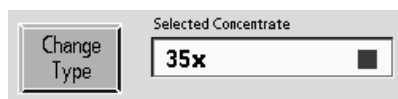

If not correct, select¹ the **Change Type** button.



Note: If the **Change Type** button is selected¹, the **Enter Conc** screen will be displayed. Change the selected concentrate and then select¹ **Calibrate Sensors** screen key and then **Temp Control** screen button to return to step 1 above.

Connect the red and blue concentrate connectors to concentrate solutions as in normal dialysis operation.

2. Press the **[CONFIRM]** key to start the calibration. The screen will change.
3. Remove the dialysate lines from the shunt and connect them to an external temperature meter. Close the shunt door.
4. Press the **[CONFIRM]** key and the screen will change.
5. The screen will display **Please wait, getting stable temperature**.

The machine will run at a 500ml/min flow rate to bring up conductivity and temperature. When the temperature becomes stable, the **Stability** counter will start to count up. As soon as it is greater than 70 a 2-minute **Timer** starts to count down. During this time the **Stability** counter will continue to increase to 100 and stay at 100 for the remaining 2-minutes. Once the 2-minutes counter reaches zero, the screen will change.



Note: If the **Stability** counter drops below 70 during the 2-minute **Timer**, the 2 minutes will be reset and will wait for the **Stability** counter to be greater than 70 again.

¹ Refer to Section 1.3 on the use of screen buttons.

6. Select¹ the Monitor Reference data button.

Adjust the value shown for Monitor Reference until it matches the external temperature and then press the [CONFIRM] key and the screen will change.

7. Press the [CONFIRM] key again and the screen will display Please wait, getting stable temperature.

The machine now runs in bypass at a 500ml/min flow rate for 2-minutes. Once the 2-minute Timer has reached zero, a 6-minute Timer is set. The machine continues to run in bypass and at a 500ml/min flow rate and depending on the stability, the 6-minute Timer may start to count down. It is normal for the Stability counter to decrease during this time. If the Stability counter becomes less than 70, the Timer will be reset to 6-minutes and will wait for the Stability counter to be greater than 70 again.

Once the 6-minute counter reaches zero, a 10-minute Timer is set. The machine comes out of bypass and changes to a 100ml/min flow rate. When the temperature becomes stable, the Stability counter will start to count up. As soon as it is greater than 70 the 10-minute Timer starts to count down. During this time the Stability counter will continue to increase to 100 and stay at 100 for the remaining 10-minutes. Once the 10-minutes Timer reaches zero, the screen will change.



Note: If the Stability counter drops below 70 during the 10-minute Timer starts, the 10-minutes will be reset and will wait for the Stability counter to be greater than 70 again.

8. Select¹ the Monitor Reference data button.

Adjust the value shown for Monitor Reference until it matches the external temperature and then press the [CONFIRM] key and the screen will change.

9. Press the [CONFIRM] key again to save the data. The screen will change.

Open the shunt to stop the dialysate flow, remove the lines from the external meter and replace them on the shunt.

Press the [CONFIRM] key to complete the calibration and return to the Calibrate Sensors screen.

¹ Refer to Section 1.3 on the use of screen buttons.

2.2.7 BLOOD LEAK CALIBRATION

The glass tube in the blood leak detector must be clean before the blood leak detector calibration can be completed successfully. The glass tube in the detector is cleaned by performing a bleach rinse, which washes the tube out along with the rest of the hydraulics.

There are two calibrations performed on the Blood Leak Detector. One calibrates the detector itself and the other calibrates the dimness circuits. Perform the procedures as described below.

From the Calibrate Sensors screen, select¹ the Blood Leak Detector screen button. The screen will change to the following:

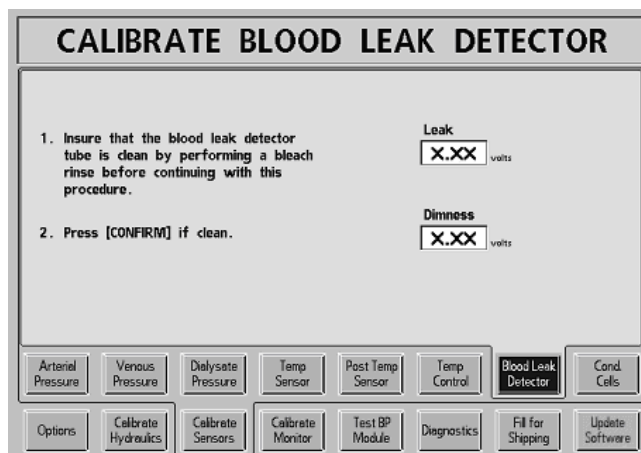

Note: The blood leak and blood dimness calibration is performed automatically. Once started, the calibration will proceed on its own until the calibration complete screen is displayed.

1. Verify that the machine has received a bleach rinse recently, or perform a bleach rinse as described in the Operator's Manual before calibrating the blood leak detector.
2. Press the [CONFIRM] key. The screen will change and the blood leak calibration will start.

¹ Refer to Section 1.3 on the use of screen buttons.

3. The first calibration that is performed is the automatic blood leak calibration. When it's finished, the screen will change.
4. The second calibration that is performed is the automatic blood dimness calibration. When it's finished, the following calibration complete screen will be displayed:

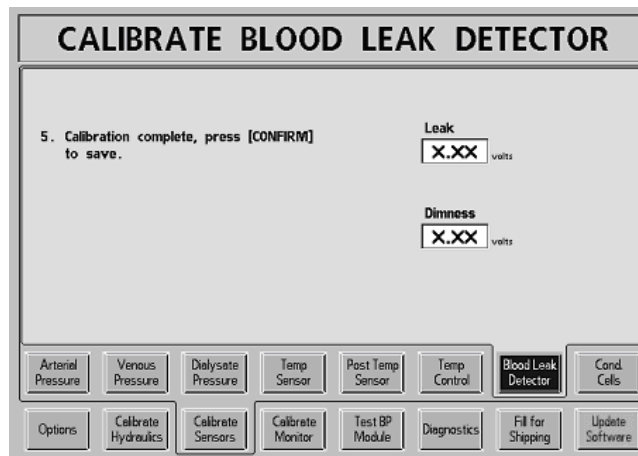

5. Press the [CONFIRM] key to save the data. The screen will change.

Press the [CONFIRM] key again to complete the calibration and return to the Calibrate Sensors screen.

2.2.8 CONDUCTIVITY CELLS CALIBRATION

Machines equipped with Online Clearance (OLC) have two conductivity cells. The first conductivity cell is PRE dialyzer and the second conductivity cell is POST dialyzer.



Note: If the Service Mode option for OLC is set to NO in Hardware Options, the post conductivity cell will not be calibrated.

From the Calibrate Sensors screen, select¹ the Cond Cells screen button. The screen will change to the following:

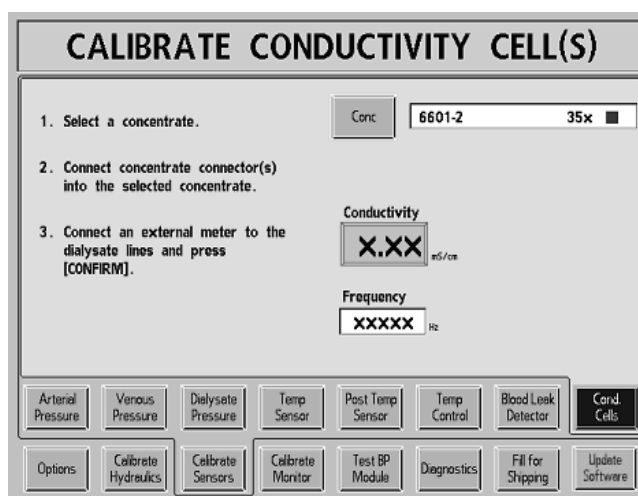

1. Identify the concentrate you will be using to calibrate the conductivity cells.

Select the concentrate by selecting¹ the Conc button. The screen will change showing a list of concentrates. Use the [+] and [-] keys to scroll through the list to locate your concentrate.



Note: In order to select¹ your concentrate from the list, it must have been previously entered in the Enter Conc screen. This screen can be found by pressing the OPTIONS screen button.

¹ Refer to Section 1.3 on the use of screen buttons.

Press the [CONFIRM] key to select your concentrate and the screen will return to the CALIBRATE CONDUCTIVITY CELL(S) screen.

2. Connect the red and blue concentrate connectors to concentrate solutions as in normal dialysis operation.
3. Remove the dialysate lines from the shunt and connect them to an external conductivity meter. Close the shunt door.



Note: If using the Automata Neo-1 meter, attach the ground strap per the manufacturer's instructions.

Press the [CONFIRM] key to start the calibration. The screen will change.

4. Wait until the conductivity value is stable. When conductivity is stable, the screen will change.
5. Once the conductivity is stable and the screen has changed, select¹ the Conductivity data button.

Adjust the value shown for Conductivity until it matches the reading on the external conductivity meter and then press the [CONFIRM] key.

6. Press the [CONFIRM] key again and the screen will change.
7. Open the shunt door and remove the external conductivity meter from the dialysate line.

Connect the dialysate lines to a large dialyzer with the blood side filled.

Close the shunt door and press the [CONFIRM] key.

8. The screen will change and the machine is now adjusting to its first reference point of conductivity for the post conductivity cell. When the reference conductivity is stable, the screen will change.
9. The machine is now adjusting to a second reference point of conductivity for the post conductivity cell. When the conductivity is stable again, the screen will change.

10. The machine is now adjusting to a third reference point of conductivity for the post conductivity cell. When the conductivity is stable again, the screen will change.
11. The machine is now adjusting to a fourth reference point of conductivity for the post conductivity cell. When the conductivity is stable again, the screen will change.

Press the [CONFIRM] key to save the data. The screen will change.

Disconnect the dialyzer and replace the dialysate lines in the shunt.

Press the [CONFIRM] key to complete the calibration and return to the **Calibrate Sensors** screen.

2.3 MONITOR CALIBRATION PROCEDURES

From the Service Mode screen, select¹ the Calibrate Monitor screen button. The following screen will appear showing the four monitor calibrations:

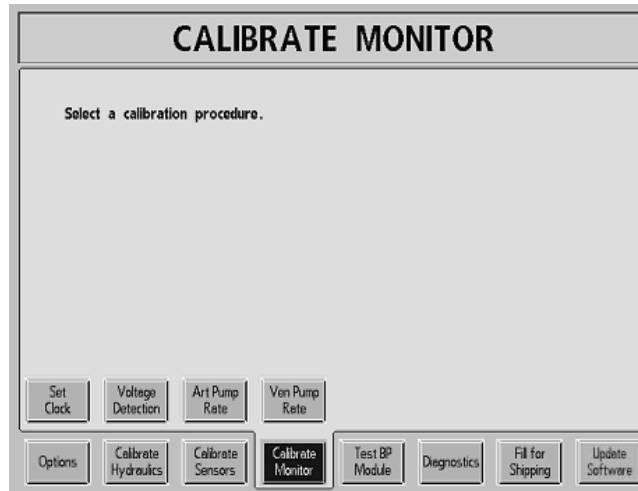

To begin a calibration, select¹ the appropriate calibration screen button.

- Set Clock
- Voltage Detection
- Arterial Pump Rate
- Venous Pump Rate

¹ Refer to Section 1.3 on the use of screen buttons.

2.3.1 **SET CLOCK**

From the Calibrate Monitor screen, select¹ the Set Clock screen button. The screen will change to the following:

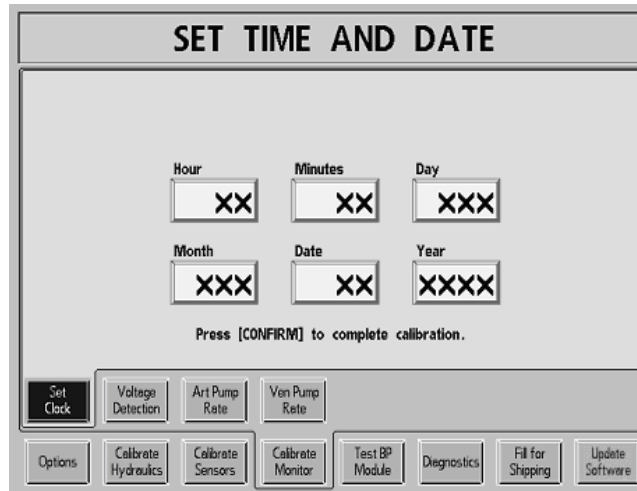

Set each value as follows:

- Select¹ the data button for the value to be changed.
- Set the correct value.
- Press the [CONFIRM] key.
- Repeat for any data button that needs to be changed.
- When all of the data has been entered, press the [CONFIRM] key to return to the Calibrate Monitor screen.

¹ Refer to Section 1.3 on the use of screen buttons.

2.3.2 VOLTAGE DETECTION CALIBRATION

From the Calibrate Monitor screen, select¹ the Voltage Detection screen button. The screen will change to the following:

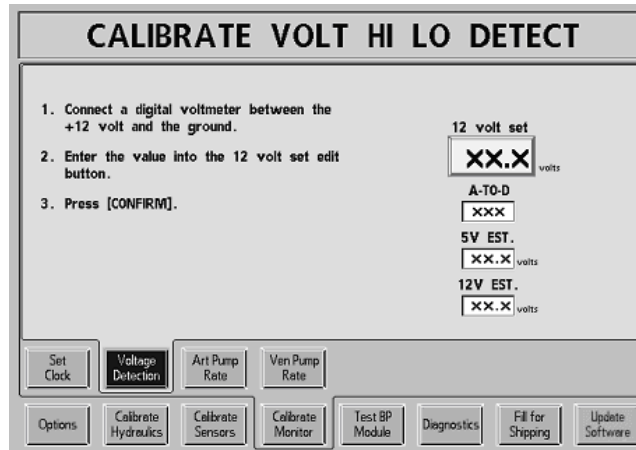

1. Open the monitor unit and connect a Digital Voltmeter between the +12 volt test and the ground test points shown in Figure 7.
2. Select¹ the 12 volt set data button.

Set the 12 volt set value to the voltage shown on the digital voltmeter, then press the [CONFIRM] key.

3. Press the [CONFIRM] key again and the screen will change.

¹ Refer to Section 1.3 on the use of screen buttons.

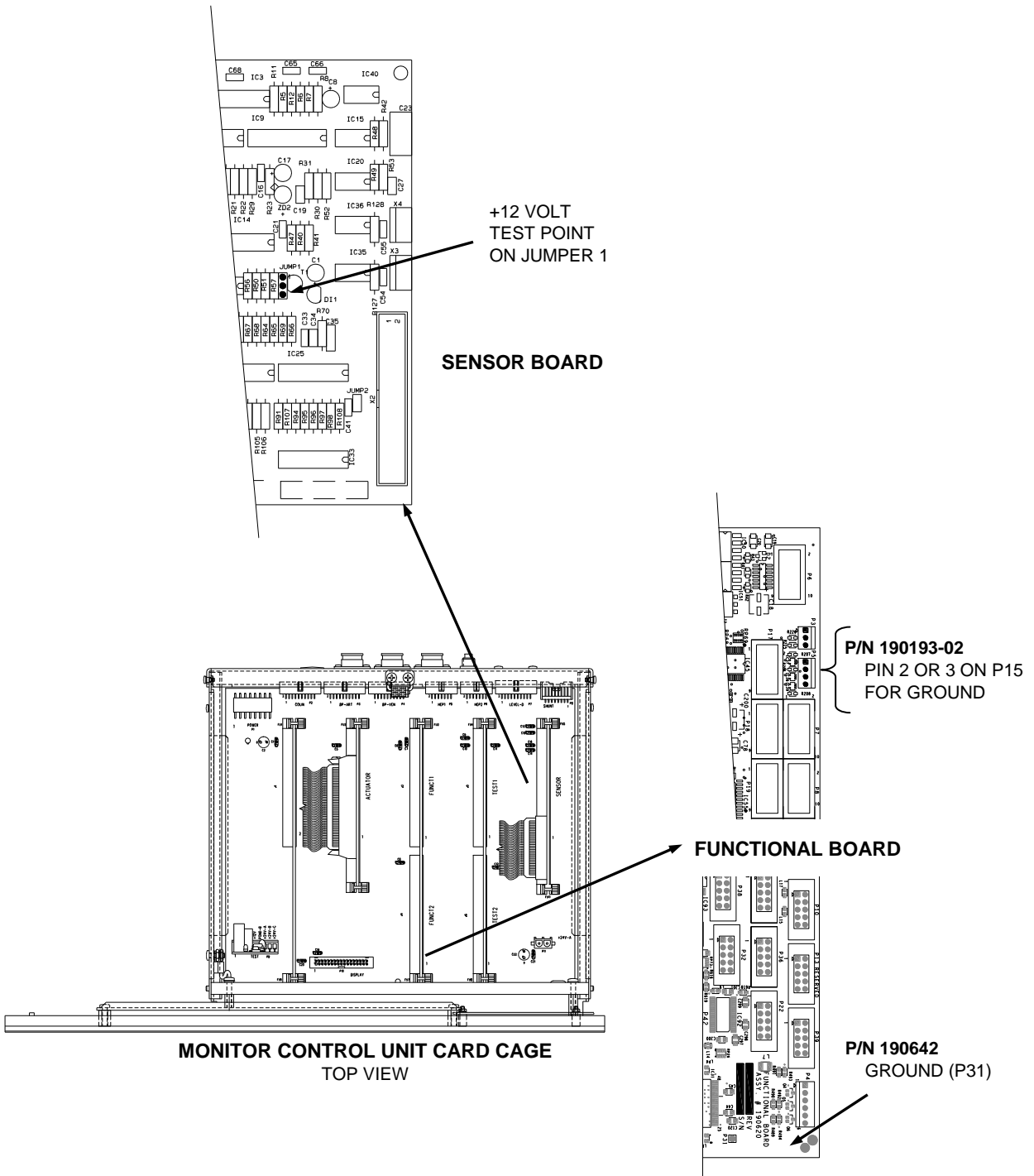
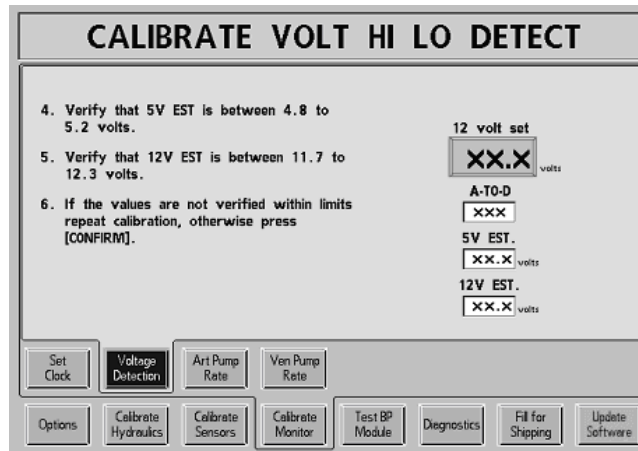

Figure 7 - +12 Volt and Ground Test Points

The screen will display:



4. Verify that the 5V EST. displayed on the screen is between 4.8 and 5.2 volts.
5. Verify that the 12V EST. displayed on the screen is between 11.7 and 12.3 volts.



Note: If the values are not within limits, repeat the Voltage Detection calibration.

6. If the values are within limits, press the [CONFIRM] key to save the data. The screen will change.

Disconnect the Digital Voltmeter and close the monitor unit.

Press the [CONFIRM] key to complete the calibration and return to the Calibrate Monitor screen.

2.3.3 ARTERIAL PUMP RATE

From the Calibrate Monitor screen, select¹ the Art Pump Rate screen button. The screen will change to the following:

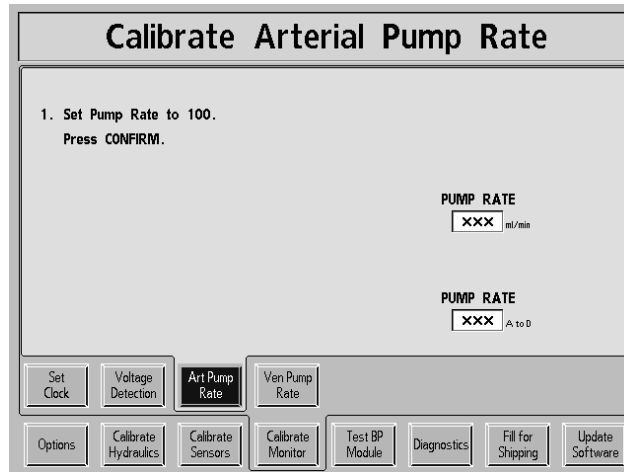

1. Adjust the arterial pump rate to 100ml/min.
Press the [CONFIRM] key and the screen will change.
2. Adjust the arterial pump rate to 400ml/min.
Press the [CONFIRM] key to save the data. The screen will change.
Press the [CONFIRM] key again to save data.
3. Press the [CONFIRM] key again to complete the calibration and return to the Calibrate Monitor screen.

¹ Refer to Section 1.3 on the use of screen buttons.

2.3.4 VENOUS PUMP RATE

From the Calibrate Monitor screen, select¹ the Ven Pump Rate screen button. The screen will change to the following:

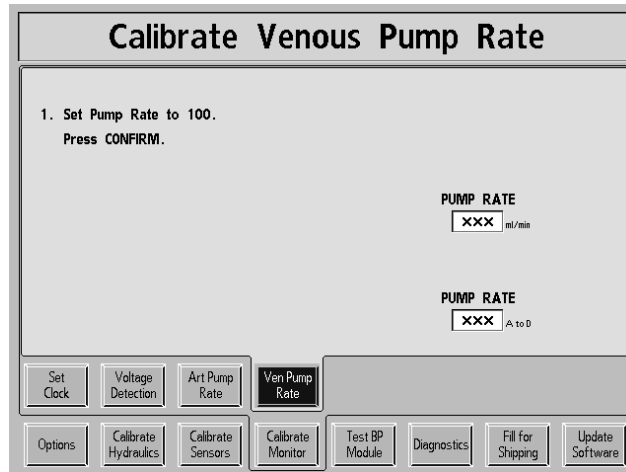

1. Adjust the venous pump rate to 100ml/min.
Press the [CONFIRM] key and the screen will change.
2. Adjust the venous pump rate to 400ml/min.
Press the [CONFIRM] key to save the data. The screen will change.
Press the [CONFIRM] key again to save data.
3. Press the [CONFIRM] key again to complete the calibration and return to the Calibrate Monitor screen.

¹ Refer to Section 1.3 on the use of screen buttons.

3.0 **CALIBRATION PROCEDURES NOT PERFORMED IN SERVICE MODE**

The following procedures are performed with the machine in normal (not Service Mode) operation (see Section 1.2).



Caution: If your machine is equipped a Service Switch on the back of the Monitor Control Unit, verify that the machine power is Off before changing the position of this switch. Failure to do so may cause calibration data to be lost.

3.1 **INLET WATER PRESSURE REGULATOR CALIBRATION**

1. Turn off the machine.
 2. Shut off the water supply to the machine.
 3. Insert a pressure gauge in the water line at the outlet of water inlet pressure regulator #61 (See Figure 1, pg. 5).
-



Caution: Use tie wraps or tubing clamps to secure the connections. The water pressure may be sufficient to blow the lines off of the gauge if they are not secured.

4. Turn the water supply to the machine On.
5. Turn the machine On.
6. With the dialysate lines in the shunt, select Dialysis Mode and start the dialysate flow. The pressure gauge will cycle between two readings as water inlet valve opens and closes.

7. On regulator #61, loosen the lock nut around the adjustment screw (See Figure 1, pg. 5). Use a 5mm Allen wrench to adjust the regulator for a peak pressure of between 18 and 20 psi when water inlet valve 41 is closed.



Note: The gauge must indicate a minimum pressure greater than 8 psi when valve 41 is open. If not, the treated water supply may not meet specifications for flow and pressure.

8. Tighten the lock nut and verify the peak pressure is still between 18 and 20 psi on the gauge.
9. Turn the machine Off, turn off the source water supply, remove the gauge and reconnect the tubing using clamps to prevent leaks.
10. Turn the treated water supply source On, turn the machine On and select¹ Dialysis Mode. Start dialysate flow and inspect all hoses and connections for leaks.

¹ Refer to Section 1.3 on the use of screen buttons.

3.2 LEVEL DETECTOR CALIBRATION

1. Place the machine in Dialysis Mode and clear all blood alarms.
2. Insert a venous chamber filled with warm water into the level detector.



Warning! For accurate calibration, use a venous chamber identical to that normally used in the machine.

3. Move the jumper on the LP241/LP450 board to the Calibrate position (see Figure 8).
4. Observe the Channel 1 LED (see Figure 8). If the LED is On, turn channel 1 potentiometer (see Figure 8) clockwise until the LED turns off.
5. Slowly turn channel 1 potentiometer counter-clockwise until the channel 1 LED switches on. Stop turning immediately, just past the point where the LED lights.
6. Repeat Steps 5 and 6 for the Channel 2 LED, adjusting channel 2 potentiometer (see Figure 8). The response of channel 2 is slower than channel 1. When adjusting to the switch point, move the potentiometer in small steps and wait to see if the LED switches on.
7. Move the jumper back to the Normal position (see Figure 8).
8. Press the [RESET] key to clear the alarm and check that both LED's are off, indicating that the Level Detector is sensing no air present in the venous chamber.
9. Remove the venous chamber and watch the LED's. Verify that channel 1 lights first followed quickly by channel 2.



Note: Channel 1 stops the blood pump and Channel 2 clamps the venous blood line.

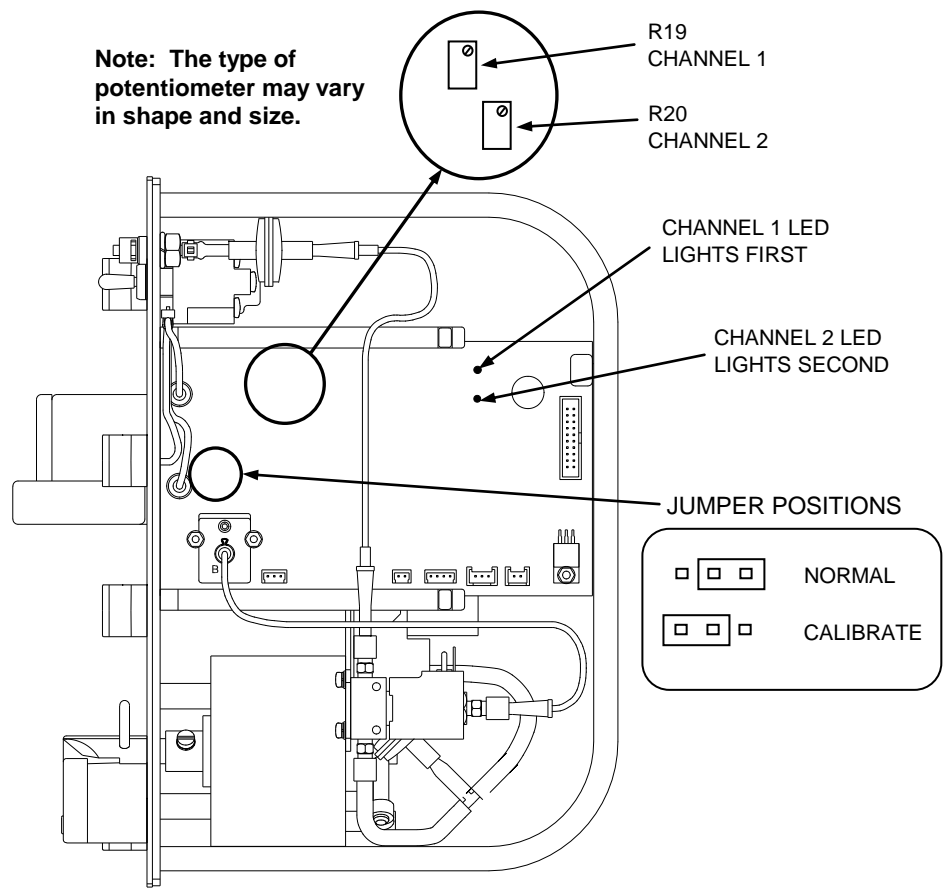

Figure 8 - Level Detector Calibration Adjustments

3.3 BLOOD PUMP CALIBRATION

The speed control circuit on a 2008K² blood pump consists of a feedback circuit that monitors the motor speed and automatically adjusts to compensate for any speed fluctuations. There are no adjustments or calibrations on this circuit.

COMMON CONVERSIONS

PRESSURE

1 Bar	29.53 inHg
1 inHg	25.4 mmHg
1 Psi	51.72 mmHg

VOLUME

1 FLUID OUNCE	29.6 MILLILITERS
1 U.S QUART	0.946 LITERS
1 U.S. GALLON	3.8 LITERS
0.034 FLUID OUNCES	1 MILLILITER
1.057 QUARTS	1 LITER
0.26 U.S. GALLON	1 LITER

MASS

1 OUNCE (avdp.)	28.35 GRAMS
1 POUND (avdp.)	0.45 KILOGRAM
0.035 OUNCE (avdp.)	1 GRAM

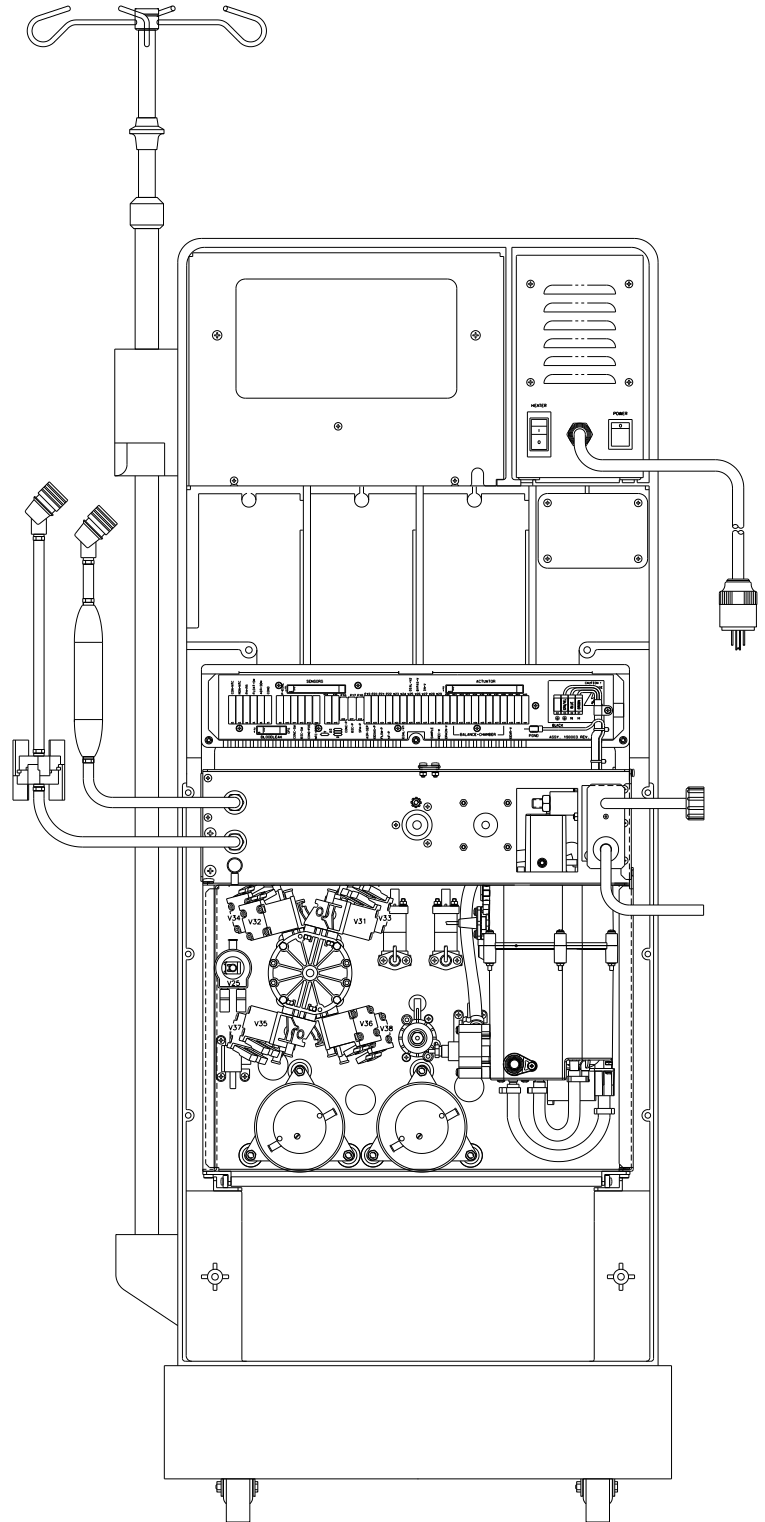

Fresenius Medical Care North America

Manufactured by:
Fresenius USA, Inc.
4040 Nelson Avenue
Concord, CA 94520
800 227-2572

<http://www.fmcna.com>